

- preference version -

Assignment of connections and functions:

- E1: venting mini-measuring connection, MA.1.St see sheet-no.1650
- E2: drainage of filter, dirt side
- E3: drainage of filter, clean side
- M1: measure connection in the housing cover, dirt side
- M2: measure connection at filter housing
p₁ = dirt side
p₂ = clean side

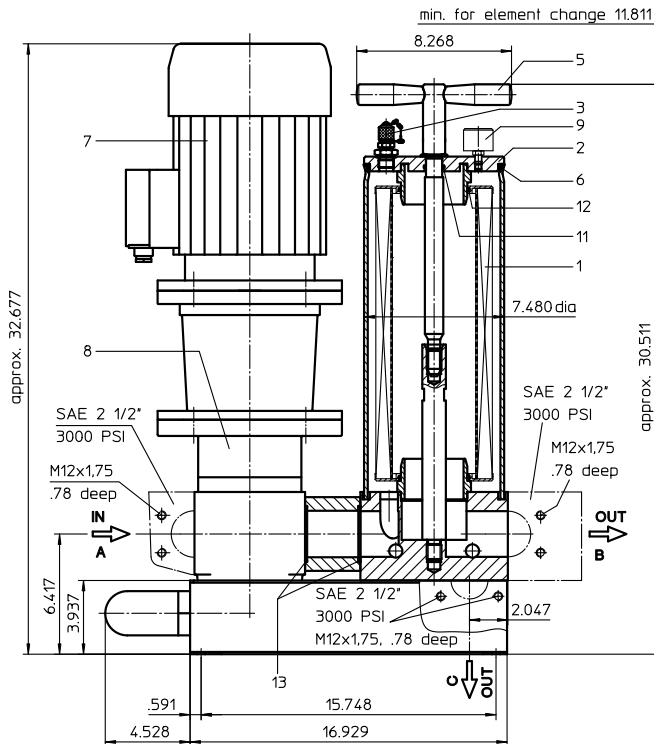
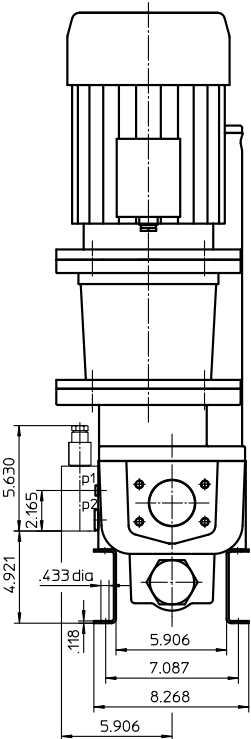
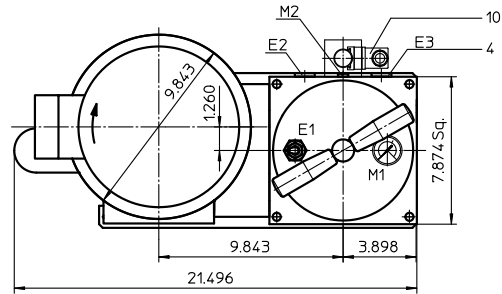

Notice:

Only operate all motors listed on this data sheet in combination with the pump unit specified on the type plate under item 8.

FILTER UNIT, stationary
Series US 320

Sheet No.
4012.1 F
Sheet 1/2

1. Type index:

1.1. Filter unit: (ordering example)

US. 320. 6VG. 10. B. P. -. P06. D08. 3. O. AE

| | | | | | | | | | | | |
|---|---|---|---|---|---|---|---|---|----|----|----|
| 1 | 2 | 3 | 4 | 5 | 6 | 7 | 8 | 9 | 10 | 11 | 12 |
|---|---|---|---|---|---|---|---|---|----|----|----|

- 1 series:
US = filter unit, stationary
- 2 nominal size: 320
- 3 filter-material and filter-fineness:
10 VG = 10 µm_(e), 6 VG = 7 µm_(e), 3 VG = 5 µm_(e), 1 VG = 4 µm_(e) Interpor fleece (glass fiber)
10 WVG = 10 µm_(e), 3 WVG = 5 µm_(e) Watersorp-filter element
- 4 resistance of pressure difference for filter element:
10 = Δp 145 PSI
- 5 filter element design:
B = both sides open
- 6 sealing material:
P = Nitrile (NBR), V = Viton (FPM), by agreement
- 7 filter element specification:
- = standard, VA = stainless steel, IS06 = see sheet-no. 31601
- 8 pump unit:
P06 = pump unit 06, NG 320.200 (standard-pump-unit / setting range 58-116 PSI)
- 9 motor: (D = rotary current motor)

| motor | electrical connection | volume flow | max. viscosity | max. pressure | on/off switch | cable | doc.-no. |
|-------------------|-----------------------|-------------|----------------|---------------|---------------|-------|----------|
| D08 ¹⁾ | 400/690V | 50Hz | 75 GPM | 46-460 SUS | 58 PSI | - | 42744-4 |
| D08 ¹⁾ | 460/790V | 60Hz | 90 GPM | 46-460 SUS | 58 PSI | - | 42744-4 |
| D24 | 400/690V | 50Hz | 75 GPM | 46-460 SUS | 58 PSI | - | 48816-4 |
| D24 | 460/790V | 60Hz | 90 GPM | 46-460 SUS | 58 PSI | - | 48816-4 |

¹⁾ standard motor

10 connection variant:

| variant | connection A type | connection A size | connection B type | connection B size | connection C type | connection C size |
|---------|-------------------|-------------------|-------------------|-------------------|-------------------|-------------------|
| 3 | FS | 9 | FS | 9 | - | - |
| 4 | FS | 9 | FS | 9 | FS | 9 |

type: FS = flange SAE 3000 PSI
size: 9 = 2 1/2"
- = no connection

11 clogging indicator at M1:

- = without
- O = visual, 36 PSI

12 clogging indicator at M2:

- = without
- AOR = AOR.2,5..., visual, at p₁ and p₂, 36 PSI, see sheet-no. 1606,
- AOC = AOC.2,5..., visual, at p₁ and p₂, 36 PSI, see sheet-no. 1606,
- AE = AE30.2,5..., electrical at p₁ and p₂, 36 PSI, see sheet-no. 1609
- OP = OP.2,5..., visual, at p₁ and p₂, 36 PSI, see sheet-no. 1628
- OE = OE.2,5..., visual-electrical, at p₁ and p₂, 36 PSI, see sheet-no. 1628
- E1 = E1.2,5 electrical at p₁, 36 PSI, see sheet-no. 1616
- E5 = E5.2,5 electrical at p₁, 36 PSI, see sheet-no. 1616

1.2. Filter element: (ordering example)

01NR. 1000. 6VG. 10. B. P. -

| | | | | | | |
|---|---|---|---|---|---|---|
| 1 | 2 | 3 | 4 | 5 | 6 | 7 |
|---|---|---|---|---|---|---|

- 1 series:
01NR. = standard-return-line filter element according to DIN 24550, T4
- 2 nominal size: 1000
- 3 - 7 see type index-filter unit

Changes of measures and design are subject to alteration!

2. Spare parts:

| item | designation | qty. | dimension | article-no. |
|------|-----------------------------|------|-------------------------|--------------|
| 1 | filter element | 1 | 01NR. 1000 | |
| 2 | housing cover | 1 | 22496-3 | 313837 |
| 3 | mini-measuring connection | 1 | MA.1.St | 305453 |
| 4 | screw plug | 2 | ½ BSPP | 304678 |
| 5 | straining screw | 1 | 31067-3 | 316893 |
| 6 | O-ring | 1 | 140 x 6 | 315392 (NBR) |
| 7 | electric motor | 1 | according to type index | |
| 8 | pump unit P06 | 1 | NG 320.200 | 316838 |
| 9 | clogging indicator (series) | 1 | visual 1.57 dia | 315452 |
| 10 | clogging indicator | 1 | according to type index | |
| 11 | O-ring | 1 | 22 x 3 | 304387 (NBR) |
| 12 | O-ring | 2 | 90 x 4 | 306941 (NBR) |
| 13 | O-ring | 2 | 69,45 x 3,53 | 305868 (NBR) |

3. Description:

The stationary filter unit is intended for oil maintenance on hydraulic systems.

The area of application comprises:

- secondary flow filtration in addition to the existing operating filter
- secondary flow filtration without the action of the operating filter
- filtration when filling the oil reservoir.

The filter unit must not be used to pump contaminated hydraulic fluids and is therefore designed without a switchover fitting to bypass the filter. The compact structural design on a base plate without pipe satisfies the prerequisites for small dimensions and high reliability.

The device is equipped with a gear pump driven by an E-motor. The flow conveyed by the geared pump is fed over a filter element to DIN 24550, T4, nominal size 1000.

Depending on the customer's wishes, the filter fineness is either 4, 5, 7 or 10 $\mu\text{m}_{(c)}$. The contamination level of the filter element can be read off from a pressure display in the cover of the filter.

At a pressure >36 PSI (red area of the scale field), the filter element is contaminated and it must be replaced with a new filter element.

The filter element can be changed without tools. After removing the straining screw and taking off the housing cover, the filter element is accessible and it can be exchanged. The filter elements are supplied complete with seals. Since it is not possible to clean the elements, the user must always keep an adequate supply of spare elements in stock.

To protect against overpressure, the filter unit is fitted with a safety valve. The initial response pressure difference valve is set according to pressure stated in the table on the type plate under item 9. If a different pressure setting is requested, please state the initial response pressure with respect to the set pressure range of the pump unit in the plain text when ordering.

Stationary filter units with motors without combined protective motor switch and ON/OFF switch and without any cable with plug (see switch „-“, cable „-“ under item 9 of the type plate) can be operated without supervision if the electrical connection is fitted with an overload protection corresponding to the current consumption of the selected E-motor and if the switch-off function of the E-motor of the electrical clogging indicator is disengaged at 36 PSI.

The line, venting and draining connections are identified according to their function. Drainage is necessary when cleaning the filter unit in connection with the change of filter element, and when setting the medium.

4. Technical data:

filter-fineness: 4, 5, 7 or 10 $\mu\text{m}_{(c)}$
 weight: approx. 243 lbs.
 operating medium: hydraulic oil based on mineral oil from 46 SUS,
 other media on request

Classified under the Pressure Vessel Directive 97/23/EC for mineral oil (fluid group 2), Article 3, Para. 3.
 Classified under ATEX Directive 94/9/EC according to specific application (see questionnaire sheet-no. 34279-4).

5. Symbols:

Filter unit without clogging indicator

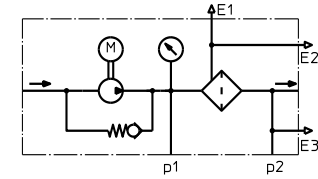

Filter unit with electrical clogging indicator AE30

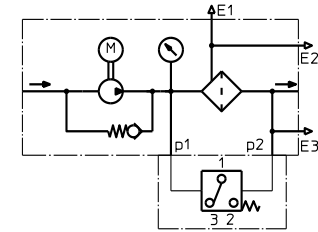

Filter unit with visual clogging indicator AOR, AOC, OP

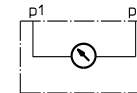

Filter unit with visual-electrical clogging indicator OE1

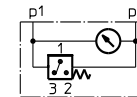

Filter unit with visual-electrical clogging indicator OE2

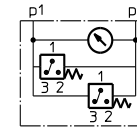

Filter unit with electrical clogging indicator contact maker E1

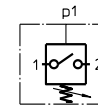

Filter unit with electrical clogging indicator contact breaker E5

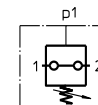

6. Test methods:

Filter elements are tested according to the following ISO standards:

| | |
|-----------|---|
| ISO 2941 | Verification of collapse/burst resistance |
| ISO 2942 | Verification of fabrication integrity |
| ISO 2943 | Verification of material compatibility with fluids |
| ISO 3723 | Method for end load test |
| ISO 3724 | Verification of flow fatigue characteristics |
| ISO 3968 | Evaluation of pressure drop versus flow characteristics |
| ISO 16889 | Multi-pass method for evaluating filtration performance |