

GUBB, GUBBD and GUBBM Cast Junction Boxes

Explosionproof, Dust-Ignitionproof

UNILETS™ for Use with Threaded Metal Conduit.

NEC/CEC — GUBB:

Class I, Division 1 and 2, Groups B, C, D
Class II, Division 1 and 2, Groups E, F, G
Class III
NEMA 3, 3R, 4, 7BCD, 9EFG

NEC/CEC — GUBBD:

Class I, Division 1 and 2, Group D
Class II, Division 1 and 2, Groups E, F, G
Class III
NEMA 3, 3R, 4

NEC/CEC — GUBBM:

Class I, Division 1 and 2, Group D
Class II, Division 1 and 2, Groups E, F, G
Class III
NEMA 3, 3R, 4

Applications

- Explosionproof and dust-ignitionproof, for use in classified locations.
- Corrosion-resistant: ideal indoors or outdoors.
- Junction or pull box for pulling and splicing of wires and as an enclosure for electrical devices.
- Ideal where number and size of conductors require a junction box with additional space.

Features

- All GUBB/GUBBD/GUBBM Series Boxes
 - Provided with mounting lugs.
 - Furnished with covers.
 - All conduit hubs and openings provide a minimum of five full threads to meet UL requirements.
 - Accurately tapped, tapered conduit threads provide tight, rigid joints and ground continuity.
- GUBB Series
 - Wide selection of sizes and locations for drilled and tapped conduit openings.
 - Suitable for use as an enclosure for relays, instrument and other control apparatus in classified locations.
 - Available in high tensile strength malleable iron or copperfree aluminum bodies.
 - Provided with mounting lugs.
 - O-rings standard for forms 1, 2 and 3 to provide raintight fit.
- GUBBD Series (Dome and Plate)
 - GUBB junction boxes with dome cover and mounting plate provide flexibility for a wide variety of applications.
 - Ideal for housing relays, contactors, terminal blocks and other classified area applications.
 - Mounting plate can be drilled to accommodate a variety of devices.
 - Dome cover has nominal depth of 152 mm (6") or 431 mm (17"), depending upon box selected. Provides significant increase in cubic inch capacity.
 - O-rings standard to provide raintight fit.
 - Provided with mounting lugs.
- GUBBM Series (Instrument)
 - GUBBM junction boxes serve as an enclosure for meters, gauges and similar devices.
 - Complete with round, explosionproof glass window cover. Permits direct reading of enclosed instrument.
 - Furnished with one 3/4" drilled and tapped entry.
 - Mounted bosses provided in back of GUBBM can be drilled and tapped for fastening of instrument mounting bracket.
 - O-rings standard to provide raintight fit.
 - Provided with mounting lugs.

Standard Materials

- GUBB bodies: copperfree (4/10 of 1% max.) aluminum or malleable iron bodies
- GUBBD bodies: malleable iron bodies
- GUBB, GUBBD covers: copperfree (4/10 of 1% max.) aluminum
- GUBBM bodies: copperfree (4/10 of 1% max.) aluminum
- GUBBM covers: copperfree (4/10 of 1% max.) aluminum and glass
- O-ring: neoprene



GUBB

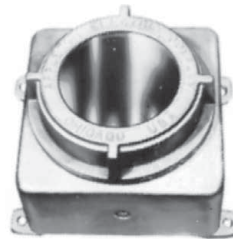

GUBBM
Instrument Box



GUBBD
Dome Cover

Standard Finishes

- GUBB malleable iron bodies: triple-coat — (1) zinc electroplate, (2) chromate, and (3) epoxy powder coat.
- GUBB aluminum covers and aluminum bodies: epoxy powder coat

Options

- GUBB
 - Less cover, add suffix —**LC**.
 - Terminal blocks. Information provided upon request.
- Instrument mounting plate and bracket for GUBBM. Information provided upon request (submit complete dimensions of instrument to be used).

NEC/CEC Certifications and Compliances

- UL Standard: UL 886 (UL 1203)
- UL Listed: E85310
- CSA Standard: C22.2 No. 25, C22.2 No. 30
- CSA Certified: 025875

GUBB Blank Body Cast Junction Boxes

Explosionproof, Dust-Ignitionproof

Drilling and tapping ordering information.

NEC/CEC:

Class I, Division 1 and 2, Groups B, C, D
 Class II, Division 1 and 2, Groups E, F, G
 Class III
 NEMA 3, 3R, 4, 7BCD, 9EFG

Determine catalog number as follows: (1) select GUBB junction box catalog number; (2) select "Conduit Opening Arrangement Diagram" number; and (3) select symbols that represent conduit opening sizes from "Symbol Table."

Where no opening is required, the symbol 0 must be inserted. Add suffix for other Optional Features. The various divisions of the complete catalog number should be separated by dashes.

Example

The junction box selected is GUBB-33 and the "Conduit Opening Arrangement" is diagram #1. Opening "a" is to be 3/4"; "b", no opening required; "c", 2"; and "d", 1-1/4".

In this example, the complete catalog number is

GUBB-33-1-BOFD

Standard Conduit Opening Arrangement Diagrams

Opening "a" is always TOP of box

Standard Conduit Opening Arrangement Diagrams

Opening "a" is always TOP of box. All conduit openings will be located in centerline of walls and evenly spaced unless otherwise specified.

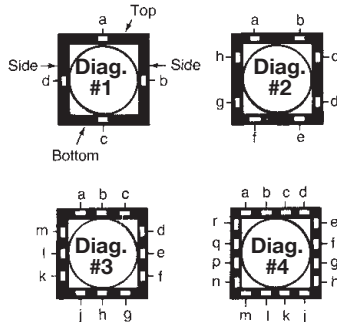

If a "Standard Conduit Opening Arrangement" is not suitable for the application, or when openings are to be more accurately spaced, submit sketch, locating openings (1) from centerlines of box and (2) from outside back of box (or from mounting lug surface if lugs are supplied).

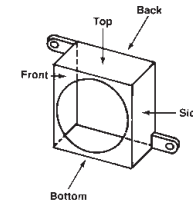

GUBB-11,22
(also GUBB-11A, 22A)

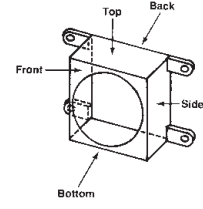

GUBB-33
(also GUBB-33A)

Symbol Table

Drilling and Tapping (Five Threads Minimum)

Conduit Size Inches	Symbol	Conduit Size Inches	Symbol
0	Blank	-	-
1/2	A	2	F
3/4	B	2-1/2	G
1	C	3	H
1-1/4	D	3-1/2	J
1-1/2	E	4	K

Minimum Recommended Spacing Between Conduit Openings

Allowance made for clearance over bushings. When unions or seals are used, additional space must be allowed.

Table shows minimum distances between conduit-opening centerlines in various size combinations. For example, if 1-1/2" and 3/4" openings are to be drilled and tapped into one side of box, the minimum spacing between centerlines would be 2.13".

Conduit Size Inches	Minimum Space Between Conduit Opening Centerlines in Millimeters (Inches)									
	1/2	3/4	1	1-1/4	1-1/2	2	2-1/2	3	3-1/2	4
1/2	31.8 (1.25)									
3/4	35.1 (1.38)	38.1 (1.50)								
1	39.6 (1.56)	42.9 (1.69)	47.8 (1.88)							
1-1/4	47.8 (1.88)	50.8 (2.00)	55.6 (2.19)	62.0 (2.44)						
1-1/2	50.8 (2.00)	54.1 (2.13)	58.7 (2.31)	66.8 (2.63)	69.9 (2.75)					
2	60.5 (2.38)	63.5 (2.50)	68.3 (2.69)	74.7 (2.94)	79.5 (3.13)	87.4 (3.44)				
2-1/2	63.5 (2.50)	66.8 (2.63)	71.4 (2.81)	79.5 (3.13)	82.6 (3.25)	92.2 (3.63)	95.3 (3.75)			
3	73.2 (2.88)	76.2 (3.00)	81.0 (3.19)	87.4 (3.44)	92.2 (3.63)	100.1 (3.94)	104.9 (4.13)	112.8 (4.44)		
3-1/2	79.5 (3.13)	82.6 (3.25)	87.4 (3.44)	95.3 (3.75)	98.6 (3.88)	108.0 (4.25)	111.3 (4.38)	120.7 (4.75)	127.0 (5.00)	
4	87.4 (3.44)	90.4 (3.56)	95.3 (3.75)	103.1 (4.06)	106.4 (4.19)	115.8 (4.56)	119.1 (4.69)	128.5 (5.06)	134.9 (5.31)	143.0 (5.63)

GUBB Blank Body Cast Junction Boxes

Explosionproof, Dust-Ignitionproof

Drilling and tapping ordering information.

NEC/CEC:

Class I, Division 1 and 2, Groups B, C, D

Class II, Division 1 and 2, Groups E, F, G

Class III

NEMA 3, 3R, 4, 7BCD, 9EFG

ENCLOSURES AND JUNCTION BOXES: NEC/CEC EXPLOSIONPROOF ENCLOSURES

Diameters of Bushings, Unions, Conduit and Seals (in Millimeters (Inches))

Conduit Size Inches	Diameters of fittings for 1/2 through 4" conduit									
	1/2	3/4	1	1-1/4	1-1/2	2	2-1/2	3	3-1/2	4
BBU Bushing	26.9 (1.06)	33.3 (1.31)	39.6 (1.56)	49.3 (1.94)	55.6 (2.19)	68.3 (2.69)	81.0 (3.19)	98.6 (3.88)	111.3 (4.38)	124.0 (4.88)
BU Bushing	28.7 (1.13)	31.8 (1.25)	41.4 (1.63)	52.3 (2.06)	58.7 (2.31)	74.7 (2.94)	82.6 (3.25)	98.6 (3.88)	115.8 (4.56)	128.5 (5.06)
UNY-UNF (R) Union	38.1 (1.50)	44.5 (1.75)	50.8 (2.00)	71.4 (2.81)	77.7 (3.06)	95.3 (3.75)	125.5 (4.94)	138.2 (5.44)	150.9 (5.94)	165.1 (6.50)
Conduit	22.4 (0.88)	26.9 (1.06)	35.1 (1.38)	42.9 (1.69)	49.3 (1.94)	60.5 (2.38)	73.2 (2.88)	88.9 (3.50)	101.6 (4.00)	114.3 (4.50)
EYM-EYF Seals T.R. ①	26.9 (1.06)	30.2 (1.19)	35.1 (1.38)	44.5 (1.75)	52.3 (2.06)	58.7 (2.31)	68.3 (2.69)	79.5 (3.13)	87.4 (3.44)	93.7 (3.69)

Wall Thickness and Maximum Conduit Size (in Millimeters (Inches))

Box Type	Top, Bottom and Sides		Back	
	Wall Thickness	Maximum Conduit Size	Wall Thickness	Maximum Conduit Size
GUBB-11, GUBB-11A	11.2 (0.44)	2	11.2 (0.44)	2
GUBB-22, GUBB-22A	11.2 (0.44)	2	16.0 (0.63)	4
GUBB-33, GUBB-33A	16.0 (0.63)	2	20.6 (0.81)	4

① T.R. is turning radius.

GUBB Cast Junction Boxes for Drilling and Tapping

Explosionproof, Dust-Ignitionproof

Drilled and tapped openings from 1/2" thru 4" as specified.

NEC/CEC:

Class I, Division 1 and 2, Groups B♦, C♦, D

Class II, Division 1 and 2, Groups E, F, G

Class III

NEMA 3, 3R, 4, 7BCD, 9EFG

	Size L x W x D mm (in)	Cover Opening mm (in)	Form Number	Volume dm ³ (in ³)	Catalog Number	
					Malleable Iron ①	Aluminum ①
	177.8 x 165.1 x 171.5 (7.00 x 6.50 x 6.75)	136.7 (5.38)	1	2.0 (120)	GUBB-11	GUBB-11A
	254.0 x 203.2 x 174.8 (10.00 x 8.00 x 6.88)	182.6 (7.19)	2	3.7 (224)	GUBB-22	GUBB-22A
	304.8 x 304.8 x 196.9 (12.00 x 12.00 x 7.75)	246.1 (9.69)	3	7.5 (455)	GUBB-33	GUBB-33A

Class I, Division 1 Sealing Requirements

Box	Group	Seals Required ♦
GUBB	B, C ♦	Yes
GUBB	D	No

Catalog Number	Mounting Lugs
GUBB-11, 11A	2
GUBB-22, 22A	2
GUBB-33, 33A	4

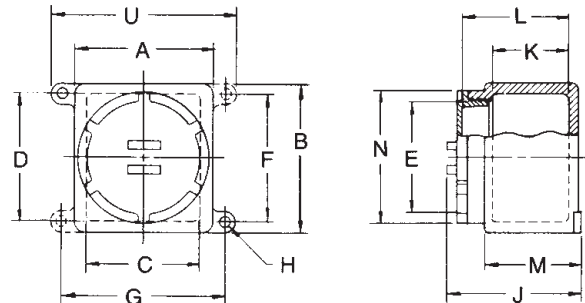

Catalog Number	Dimensions in Millimeters (Inches)													
	A	B	C	D	E	F	G	H	J	K ^②	L	M	N	U
GUBB-11	165.1	177.8	139.7	150.9	163.7	152.4	196.9	12.7	171.5	93.7	133.4	117.6	158.8	222.3
GUBB-11A	(6.50)	(7.00)	(5.50)	(5.94)	(5.38)	(6.00)	(7.75)	(0.50)	(6.75)	(3.69)	(5.25)	(4.63)	(6.25)	(8.75)
GUBB-22	203.2	254.0	181.1	228.6	182.6	228.6	235.0	12.7	174.8	88.9	133.4	117.6	203.2	260.4
GUBB-22A	(8.00)	(10.00)	(7.13)	(9.00)	(7.19)	(9.00)	(9.25)	(0.50)	(6.88)	(3.50)	(5.25)	(4.63)	(8.00)	(10.25)
GUBB-33	304.8	304.8	273.1	273.1	246.1	254.0	333.5	16.0	196.9	100.0	146.1	136.7	279.4	365.3
GUBB-33A	(12.00)	(12.00)	(10.75)	(10.75)	(9.69)	(10.00)	(13.13)	(0.63)	(7.75)	(3.94)	(5.75)	(5.38)	(11.00)	(14.38)

① Malleable iron and aluminum boxes furnished with aluminum cover.

② Inside dimensions.

♦ Sealing fitting must be installed within 2" of each conduit entrance (max. conduit for Group B and C is 2"). Seals not required in Class I, Division 2 areas provided there are no arcing or sparking devices in the box.

GUBBM Instrument Enclosures



Explosionproof, Dust-Ignitionproof

GUBBM: Furnished with one 3/4" threaded conduit opening. Aluminum body with aluminum/glass cover.

NEC/CEC:

Class I, Division 1 and 2, Group D
 Class II, Division 1 and 2, Groups E, F, G
 Class III
 NEMA 3, 3R, 4

ENCLOSURES AND JUNCTION BOXES: NEC/CEC EXPLOSIONPROOF ENCLOSURES

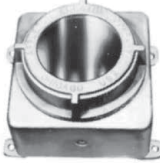
	Type Box	Conduit Opening Size (Inches-NPT)	Cover Opening mm (in)	Wall Thickness mm (in)	Form Number	Catalog Number
	GUBB-11A	3/4	136.7 (5.38)	11.2 (0.44)	1	GUBBM-1A
	GUBB-22A	3/4	182.6 (7.19)	11.2 (0.44)	2	GUBBM-2A
	GUBB-33A	3/4	246.1 (9.69)	14.2 (0.56)	3	GUBBM-3A

Other drilled and tapped conduit opening arrangements and sizes available in addition to the one 3/4" conduit opening provided.

GUBB Cast Junction Boxes for Drilling and Tapping Blank Body Ordering Information

For Covers and Mounting Plates, Order from GUBB Surface and Special Purpose Covers page.

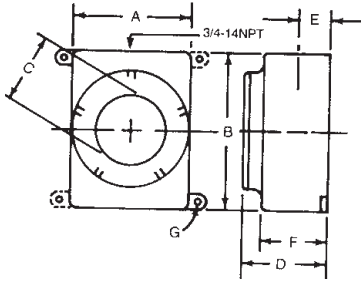
	Type Box	Mounting Lugs	Dimensions in Millimeters (Inches)						
			A	B	C	D	E	F	G
	GUBBM-1A	2	165.1 (6.50)	177.8 (7.00)	79.5 (3.13)	143.0 (5.63)	52.3 (2.06)	117.6 (4.63)	12.7 (0.50)
	GUBBM-2A	2	203.2 (8.00)	254.0 (10.00)	120.7 (4.75)	143.0 (5.63)	52.3 (2.06)	117.6 (4.63)	12.7 (0.50)
	GUBBM-3A	4	304.8 (12.00)	304.8 (12.00)	174.8 (6.88)	227.1 (8.94)	88.9 (3.50)	136.7 (5.38)	16.0 (0.63)



GUBBD Cast Boxes With Dome Cover and Mounting Plate

Explosionproof, Dust-Ignitionproof

Malleable iron junction boxes furnished with aluminum cover. For drilling and tapping.

NEC/CEC:

Class I, Division 1 and 2, Group D
 Class II, Division 1 and 2, Groups E, F, G
 Class III
 NEMA 3, 3R, 4

	Nominal Cover Depth mm (in)	Width of Mounting Plate mm (in)	Adjustment mm (in) ①	Form Number	Catalog Number
 Cover removed, showing mounting plate	254.0 (10.00)	88.9 (3.50)	25.4 (1.00)	1	GUBBD-1-10
	152.4 (6.00)				GUBBD-2-6
 Body with dome cover	304.8 (12.00)	124.0 (4.88)	38.1 (1.50)	2	GUBBD-2-12
	152.4 (6.00)				GUBBD-3-6
	304.8 (12.00)	158.8 (6.25)	54.1 (2.13)	3	GUBBD-3-12
	431.8 (17.00)				GUBBD-3-17

Dimensions in Millimeters (Inches)

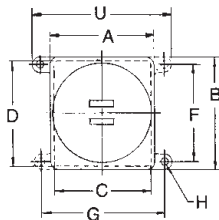

GUBBD-1 (2 Lugs), GUBBD-2 (2 Lugs), GUBBD-3 (4 Lugs)

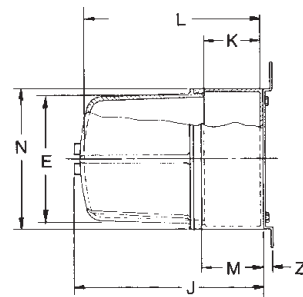

All Types

Catalog Number	Dimensions in Millimeters (Inches)													
	A	B	C ②	D ②	E	F	G	H	J	K ②	L ②	M	N	U
GUBBD-1-10	165.1 (6.50)	177.8 (7.00)	153.9 (6.06)	166.6 (6.56)	136.7 (5.38)	152.4 (6.00)	196.9 (7.75)	12.7 (0.50)	409.7 (16.13)	95.3 (3.75)	374.7 (14.75)	117.6 (4.63)	41.0 (6.25)	222.3 (8.75)
GUBBD-2-6	203.2 (8.00)	254.0 (10.00)	192.0 (7.56)	242.8 (9.56)	182.6 (7.19)	228.6 (9.00)	235.0 (9.25)	12.7 (0.50)	309.6 (12.19)	96.8 (3.81)	273.1 (10.75)	117.6 (4.63)	77.1 (8.06)	260.4 (10.25)
GUBBD-2-12	203.2 (8.00)	254.0 (10.00)	192.0 (7.56)	242.8 (9.56)	182.6 (7.19)	228.6 (9.00)	235.0 (9.25)	12.7 (0.50)	462.0 (18.19)	96.8 (3.81)	425.5 (16.75)	117.6 (4.63)	77.1 (8.06)	260.4 (10.25)
GUBBD-3-6	304.8 (12.00)	304.8 (12.00)	289.1 (11.38)	289.1 (11.38)	246.1 (9.69)	254.0 (10.00)	333.5 (13.13)	16.0 (0.63)	350.8 (13.81)	111.3 (4.38)	293.6 (11.56)	136.7 (5.38)	125.2 (11.00)	365.3 (14.38)
GUBBD-3-12	304.8 (12.00)	304.8 (12.00)	289.1 (11.38)	289.1 (11.38)	246.1 (9.69)	254.0 (10.00)	333.5 (13.13)	16.0 (0.63)	503.2 (19.81)	111.3 (4.38)	446.0 (17.56)	136.7 (5.38)	125.2 (11.00)	365.3 (14.38)
GUBBD-3-17	304.8 (12.00)	304.8 (12.00)	289.1 (11.38)	289.1 (11.38)	246.1 (9.69)	254.0 (10.00)	333.5 (13.13)	16.0 (0.63)	642.9 (25.31)	111.3 (4.38)	585.7 (23.06)	136.7 (5.38)	125.2 (11.00)	365.3 (14.38)

① Mounting plate is adjustable. May be centered or located to one side.
 ② Inside dimensions.



GUBB/GUBBD/GUBBM Cast Junction Box Covers

Explosionproof, Dust-Ignitionproof

Covers provide raintight fit when used with O-rings. Available in malleable iron, aluminum, and aluminum/glass.

NEC/CEC:
 Class I, Division 1 and 2, Group D
 Class II, Division 1 and 2, Groups E, F, G
 Class III
 NEMA 3, 3R, 4

ENCLOSURES AND JUNCTION BOXES: NEC/CEC EXPLOSIONPROOF ENCLOSURES

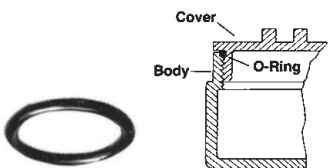
		Fits Box Catalog Number	Nominal Cover Depth mm (in)	Nominal Cover Diameter mm (in)	Window Diameter mm (in)	Form Number	Catalog Number
Covers — Aluminum — O-ring Gasket Included							
 <p>GUBK-1, GUBK-2 GUBK-3</p>	GUBB-11 (11A)		Surface	136.7 (5.38)	53.8 (2.12)	1	GUBK-1
	GUBB-22 (22A)		Surface	182.6 (7.19)	120.7 (4.75)	2	GUBK-2
	GUBB-33 (33A)		Surface	246.1 (9.69)	177.8 (7.00)	3	GUBK-3
Instrument Box Covers — Aluminum and Glass							
 <p>GUBMK-1, GUBMK-2 GUBMK-3</p>	GUBB-11 (11A)		—	136.7 (5.38)		1	GUBMK-1
	GUBB-22 (22A)		—	182.6 (7.19)		2	GUBMK-2
	GUBB-33 (33A)		—	246.1 (9.69)		3	GUBMK-3
Dome Covers for GUBB Boxes — Aluminum — O-ring Gasket Included							
	GUBB-11 (11A)		254.0 (10.00)	136.7 (5.3)		1	GUBK-1-10
	GUBB-22 (22A)		152.4 (6.00)	182.6 (7.19)		2	GUBK-2-6
	GUBB-22 (22A)		304.8 (12.00)	182.6 (7.19)		2	GUBK-2-12
	GUBB-33 (33A)		152.4 (6.00)	246.1 (9.69)		3	GUBK-3-6
	GUBB-33 (33A)		304.8 (12.00)	246.1 (9.69)		3	GUBK-3-12
	GUBB-33 (33A)		431.8 (17.00)	246.1 (9.69)		3	GUBK-3-17
Replacement O-rings — Neoprene							
	Provide raintight fit for GUBB, GUBBM and GUBBD Boxes						
	GUBB-11 (11A)					1	GUBG-1
	GUBB-22 (22A)					2	GUBG-2
	GUBB-33 (33A)					3	GUBG-3
Mounting Plates — 3.3 mm (0.13") Thick Aluminum. 4 standoffs, 4 mounting screws							
	GUBB-11 (11A) ①			114.3 x 114.3 (4.50 x 4.50)		1	GUBBMP-11
	GUBB-22 (22A) ①			165.1 x 165.1 (6.50 x 6.50)		2	GUBBMP-22
	GUBB-33 (33A) ①			228.6 x 228.6 (9.00 x 9.00)		3	GUBBMP-33

① GUBB boxes are Pre-Drilled to accept a mounting plate.