



Handheld calibration and cleaning tools

- Manual cleaning or calibration of sensors on demand
- To ensure individual quality standards and guidelines
- Reliable and long-term accurate measurements
- Flexible use for cost-effective, on-site quality management

Type MZ15 can be combined with...



Type 8905

Online analysis system



Type MS01

pH sensor cube

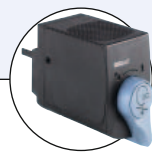

Type MS03

Conductivity sensor cube



Type MS04

ORP sensor cube

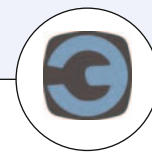



Type 8920

Communicator

The MZ15 tool is easy to use and can be used to individually calibrate or clean the sensor cubes used in the online analysis system, Type 8905.

This accessory for the online analysis system, Type 8905, also makes it possible to extend the flexibility of the latter, and thus also its economical and rapid operation.

The MZ15 handheld cleaning or calibration tool simply meets individual performance standards.

| General data | Calibration tool | Cleaning tool |
|--|--|---------------------------------------|
| Compatibility | With Type MS01, MS03 or MS04 sensor cube and Type 8905 Online analysis system (see corresponding datasheets) | |
| Materials | Housing: ABS Screws: Stainless steel, steel passivated Fixed connector M12: Zn, CuZn, Au, PA Wetted parts materials: EPDM Seal: PA, POM, PPS, silicone Others: | |
| Electrical connection | M12 male connector (bùS) | - |
| Fluidic connection | Holder for 2 bottles with suction hose | Holder for 1 bottle with suction hose |
| Type of fluid | Calibration solution | Cleaning solution |
| Weight (without bottle) | approx. 900 g | approx. 610 g |
| Environment | | |
| Ambient temperature | +3...+40 °C | |
| Relative humidity | < 90 %, without condensation | |
| Height above sea level | Max. 2000 m | |
| Electrical data | | |
| Operating voltage | 4 x 1.5 V DC non-rechargeable alkaline (LR6 AA) batteries | |
| Sensor powering | via connected M12 plug | - |
| Standard, directives and certification | | |
| Protection class | IP20 (acc. to EN 60529) | |
| Standard and directives  | The applied standards, which verify conformity with the EU Directives, can be found on the EU Type Examination Certificate and/or the EU Declaration of conformity (if applicable) | |
| Certification | UL-Recognized for US and Canada  UL61010-1 + CAN/CSA-C22.2 No.61010-1 (pending) | |

Design and principle of operation

The handheld tool is an accessory designed to clean or calibrate the sensor cubes MS01, MS03 or MS04 for the online analysis system, Type 8905. The sensor cube, to be cleaned or calibrated, must be removed from the backplane of the 8905 system and inserted on the backplane of the portable cleaning or calibration tool.

Handheld calibration tool

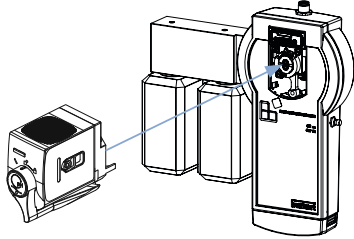

The portable calibration tool must be connected to the 8905 online analysis system via a bus connection cable to access the calibration menu of the connected sensor. The portable calibration tool is equipped with a connection bracket, to which two bottles are to be screwed, one containing the calibration solution and the second used to recover the used solution. A pump sucks this solution through a pipe and returns it to the sensor cube. The calibration must be carried out according to the respective instructions of the sensor cube.

Handheld cleaning tool

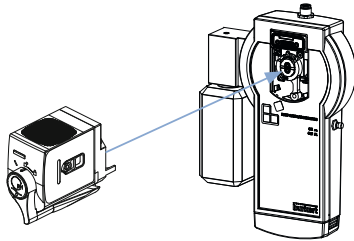

The portable cleaning tool is equipped with a connection bracket, to which a bottle containing the cleaning solution must be screwed. A pump sucks this solution through a pipe and returns it to the sensor cube. The cleaning solution is pumped into the circuit for use and diluted with the residual water sample. The duration of the cleaning cycle, selected manually, depends on the degree of pollution. The cleaning solution can be used up to five times. After a cleaning cycle, a little cleaning solution remains in the sensor cube, which could spread into the on-line analysis system. If the cleaning solution has not been completely removed, the sensor cube must be rinsed with the Bürkert flushing liquid.

Dimensions [mm]

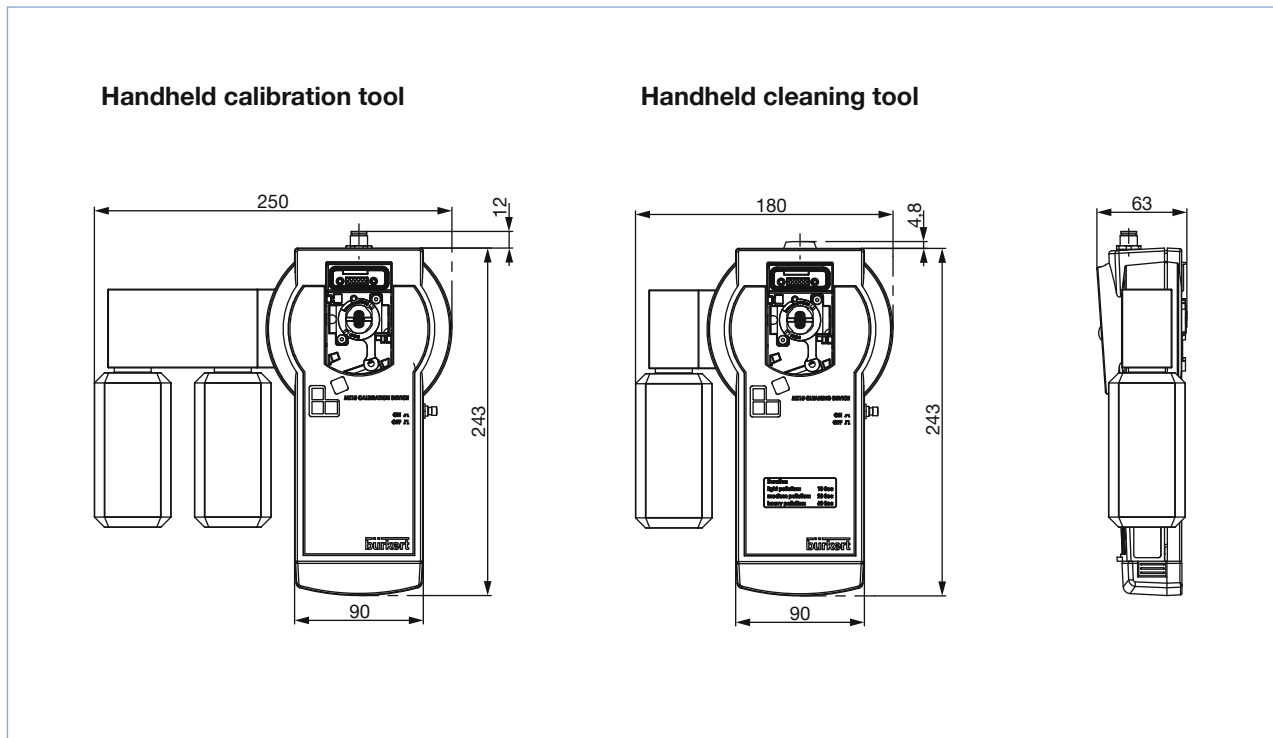

Ordering chart Type MZ15

| Specification | Item no. |
|---------------------------|----------|
| Handheld calibration tool | 568 805 |
| Handheld cleaning tool | 568 804 |

Ordering chart - accessories (has to be ordered separately)

| Specification | Item no. |
|---|----------|
| Calibration solution pH 5.00 (20 °C), 50 ml | 806 698 |
| Calibration solution pH 7.00 (20 °C), 50 ml | 806 699 |
| Calibration solution pH 9.00 (20 °C), 50 ml | 806 700 |
| Flushing liquid, 50 ml | 806 709 |
| Flushing liquid, 250 ml | 806 710 |
| Calibration solution ORP 475 mV, 50 ml | 806 045 |
| Calibration solution conductivity 5 mS/cm (25 °C), 50 ml | 807 199 |
| Acidic cleaning solution, 250 ml | 807 478 |
| Alkaline cleaning solution, 250 ml | 807 486 |
| büS extension cable, M12 straight cable plug male/female, 1 m | 772 404 |
| büS extension cable, M12 straight cable plug male/female, 3 m | 772 405 |
| büS extension cable, M12 straight cable plug male/female, 5 m | 772 406 |
| büS-Y-splitter | 772 420 |
|  USB-büS-Interface (see drawing below) | 772 426 |

USB-büS-Interface



Interconnection possibilities with other Bürkert tools

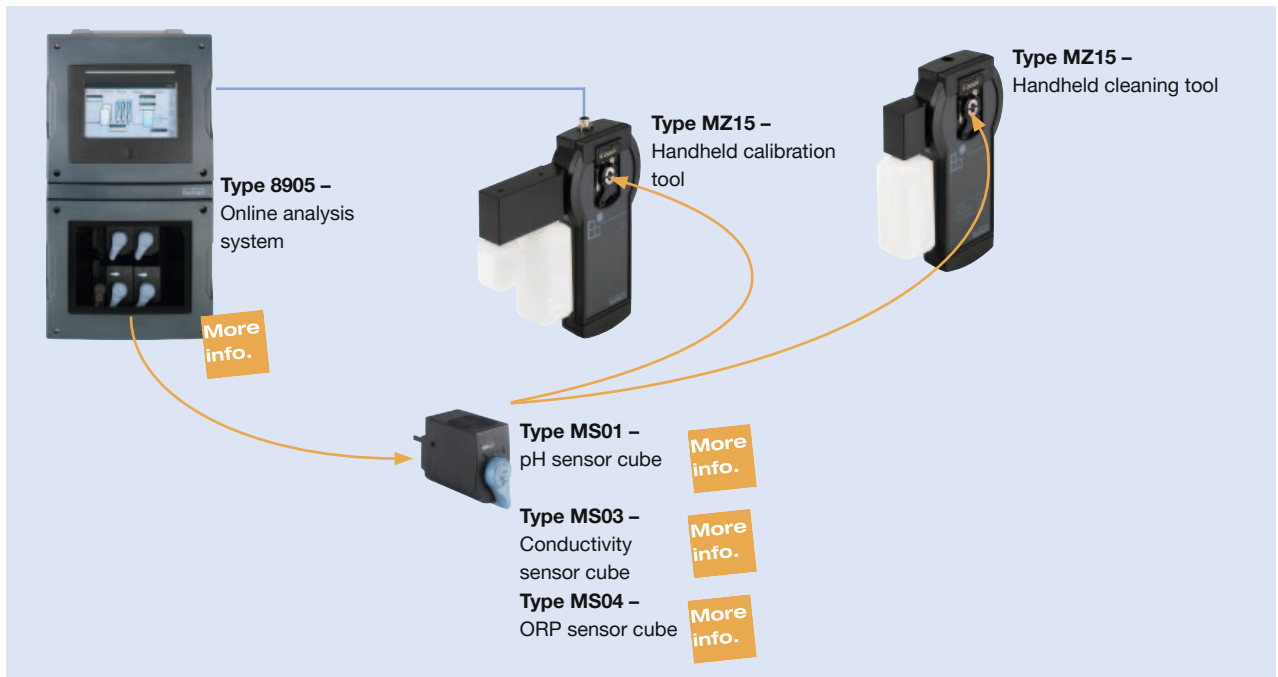

DTS 1000326996 EN Version: - Status: RL (released | freigegeben | validé) printed: 12.06.2017

To find your nearest Bürkert facility, click on the orange box →

www.burkert.com

In case of special application conditions, please consult for advice.

Subject to alteration.
© Christian Bürkert GmbH & Co. KG

1706/0_EU-en_00895326