

Intraground™ N1 Series Control Stations

Nonmetallic

10 Amp, 600 Vac Max. for Heavy Duty Use.

NEC — N1 Series (Non-Factory Sealed): Ⓞ
Class I, Division 1 and 2, Groups C, D
NEMA 3R, 4X, 7CD, 12

Applications

- Listed for use in Class I, Division 1 and 2, Group C and D atmospheres such as:
 - Diethyl ether
 - Methyl ethyl ketone
 - Acetone
 - Toluene
 - No. 3 fuel oil
 - Ammonium hydroxide (20%)
 - Benzene
 - Regular unleaded gas
 - Ethyl acetate
 - Hexane
 - Methanol
- Not suitable for:
 - Ethylene dichloride
 - Partially halogenated hydrocarbons
- Sealing fittings must be field installed adjacent to enclosure on all conduit runs.
- Explosionproof, with sealing fittings installed at each conduit entrance, the N1 Series enclosures withstood a hydrostatic test of four times the maximum internal explosion pressure that could be developed from a gas or vapor explosion.
- Push buttons and selector switches are used in conjunction with contactors or magnetic starters for remote control of motors in hazardous locations. They provide circuit control and/or selection.
- Pilot lights provide visual assurance that an electrical function is being performed at a remote or local hazardous location.

Features

- Nonmetallic construction with metal imbedded grounding grid. No need to install special wires and parts for grounding. Feed-thru or dead-end grounded 1/2" or 3/4" conduit openings for threaded conduit.
- Special grounding wire furnished with each box provides safe grounding when cover is removed.
- Ideal for use in corrosive environments. Nonmetallic enclosures with corrosion resistant parts coated with epoxy, Teflon® ① or Mylar® ②, these control stations offer unsurpassed resistance to chemicals.
- Unique labyrinth-path construction assures flame-tight joint between body and cover.
- Silicone gasket, specially designed for the labyrinth-path joint, prevents entrance of moisture without interfering with the venting of cooled hazardous gases and vapors.
- Typical mechanical properties of 24,500 psi tensile strength, 3% elongation at break, 33,000 psi flexural strength, and 1,200,000 psi flexural modulus.
- Electrical properties of sample specimens: dielectric strength (in air) of 769 at 1/16".
- High strength thermoplastic polyetherimide, together with thick walls (5/16") and sound structural design (rounded corners) provides superior resistance to impact and crushing.
- Excellent resistance to ultraviolet light and water.
- Excellent conduit connection strength.
- Excellent resistance to attack by fungi and mold.
- Superior flammability resistance.



Push Button



Pilot Light



Selector Switch



Combination Push Button and Pilot Light



Combination Selector Switch and Pilot Light

Related Products

- Sealing fitting must be installed at each conduit entrance of the N1 enclosure to be explosionproof. See *Hazardous Location Fittings Section*.

Appleton

CONTROLS: NEC/CEC EXPLOSIONPROOF CONTROL STATIONS AND SWITCHES

Ⓞ For Class I, Division 1 applications, sealing fittings must be field installed adjacent to enclosure on all conduit runs.

① Teflon and Mylar are registered trademarks of E. I. du Pont de Nemours and Company.

Intraground™ N2 Series Control Stations

Nonmetallic

10 Ampere, 600 Vac Max. for Heavy Duty Use.

NEC — N2 Series (Factory Sealed):
Class I, Division 2, Groups B, C, D
Class II, Division 1 and 2, Groups E, F, G
Class III
NEMA 3R, 4X, 9EFG, 12

Applications

- Listed for use in Class I, Division 2, Group B, C and D atmospheres such as:
 - Diethyl ether
 - Methyl ethyl ketone
 - Acetone
 - Toluene
 - No. 3 fuel oil
 - Ammonium hydroxide (20%)
 - Benzene
 - Regular unleaded gas
 - Ethyl acetate
 - Hexane
 - Methanol.
- Listed for use in Class II, Division 1 and 2, Groups E, F and G.
- Dust-tight construction. After 32 hour UL test, no magnesium dust entered the enclosure.
- Push buttons and selector switches are used in conjunction with contactors or magnetic starters for remote control of motors in hazardous locations. They provide circuit control and/or selection.
- Pilot lights provide visual assurance that an electrical function is being performed at a remote or local hazardous location.

Features

- Factory sealed — no external seals required.
- Nonmetallic construction with metal imbedded grounding grid. No need to install special wires and parts for grounding. Feed-thru or dead-end grounded 1/2" or 3/4" conduit openings for threaded conduit.
- Special grounding wire furnished with each box provides safe grounding when cover is removed.
- Ideal for use in corrosive environments. Nonmetallic enclosures with corrosion resistant parts coated with epoxy, Teflon® ① or Mylar® ①, these control stations offer unsurpassed resistance to chemicals.
- Silicone gasket, specially designed for the labyrinth-path point between cover and body, prevents entrance of moisture and dust.
- Molded of high-tensile 30% glass reinforced thermoplastic polyetherimide. Enclosure walls are 5/16" thick.
- Typical mechanical properties of 17,000 psi tensile strength, 3% elongation at break, 27,000 psi flexural strength, and 1,100,000 psi flexural modulus (UL tests showed 18,918 psi tensile strength and 30,675 psi flexural strength).
- Electrical properties of sample specimens: dielectric strength of 490 at 1/8" and a comparative track index of 185V/0.058".
- Superior impact resistance.
- Extremely low water absorption. This important quality assures dimensional stability.
- Excellent resistance to ultraviolet light and water.
- UL Temperature Index (continuous use temperature): +130 °C (+266 °F) electrical properties, +130 °C (+266 °F) mechanical properties with impact, and +140 °C (+284 °F) mechanical properties without impact.
- Superior flammability resistance.
- Excellent pull-out resistance.



Push Button



Pilot Light



Selector Switch



Combination Push Button and Pilot Light



Combination Selector Switch and Pilot Light

① Teflon and Mylar are registered trademarks of E. I. du Pont de Nemours and Company.

Intraground™ N1 and N2 Series Control Stations

Nonmetallic

10 Ampere, 600 Vac Max. for Heavy Duty Use.

NEC — N1 Series (Non-Factory Sealed): ☉
Class I, Division 1 and 2, Groups C, D
NEMA 3R, 4X, 7CD, 12

NEC — N2 Series (Factory Sealed):
Class I, Division 2, Groups B, C, D
Class II, Division 1 and 2, Groups E, F, G
Class III
NEMA 3R, 4X, 9EFG, 12

Features

- Heavy duty push button, 10 Amp 600 Vac rated.
- Dozens of possible combinations of push buttons, pilot lights and selector switches.
- Smooth, rounded integral bushing in each conduit opening protects conduct or insulation.
- Accurately tapped, tapered conduit openings for tight, rigid joints and ground continuity.
- Push Buttons, Selector Switches, and Pilot Lights
 - Stainless steel push button shaft operates within stainless steel bushing, assuring long, maintenance-free operation.
 - Push button and selector switch contacts are silver cadmium oxide which are "sealed" in lower phenolic chamber isolated from corrosive elements. Assures positive contact and long, trouble-free operation.
 - Enclosed stainless steel helper spring prevents accidental operation of push button in severe vibration installations.
 - Corrosion resistant stainless steel Teflon® ① coated hex head cap screws hold covers to body.
 - Push buttons are supplied with lockout type guards as standard. Hole in guard will accept locks with up to 1/4" hasp. Permits locking of push button to prevent unauthorized operation.
 - Clearly marked terminals with brass screws assure quick, easy wiring.
 - Pilot light supplied with jewel/guard assembly and 120 Vac, 6 Watt type 6S6 lamp, 120 Vac/Vdc, 50/60 Hz, 6 Watt.

Standard Materials

- Body and cover: 30% glass-reinforced thermoplastic polyetherimide
- SPBB push button: aluminum upper barrel and phenolic lower barrel with nylon plastic button. Glass reinforced polypropylene guard. Silicone weather boot. Aluminum nameplate
- SPLS pilot light: aluminum guard and body assembly; steel clamping ring; and tempered glass jewel
- SSBA selector switch: aluminum housing, nylon knobs and cams, and sealed phenolic contact block
- NBN rectangular button with weather boot: Nylon plastic button with neoprene weather boot. Aluminum nameplate
- NMRB mushroom button with weather boot: anodized aluminum buttons with neoprene weather boot
- Selector switch locking devices and push button securing rods: stainless steel
- Cover bolts: stainless steel
- Nameplates: copperfree (4/10 of 1% max.) aluminum
- Receptacles: copperfree (4/10 of 1% max.) aluminum

Standard Finishes

- Cover bolts: Teflon® ①
- Nameplates: Mylar® ①
- Pilot light guard and clamping ring: epoxy

Options

- Three position selector switches with modified operation. For description and switch diagram, refer to switch operators.
 - Momentary contact right position, spring return to center, maintained contact left position. Add suffix **-SRC**.
 - Momentary contact left position, spring return to center, maintained contact right position. Add suffix **-SLC**.
- Alternate contacts add suffix **-ALT**.
- Selector switch Lockout: locks 2- or 3-position handle in any position. Suffix **-LD**.
- Push button front operated mushroom head (momentary contact):
 - Red **-NMRBRE**
 - Green **-NMRBGR**
 - Black, add suffix **-NMRBBL**.
- Pilot light jewel/guard assembly. Order by suffixes if color desired is other than red, as follows:
 - Amber **-JGBA**
 - Blue **-JGBB**
 - Clear **-JGBC**
 - Green **-JGBG**
 - Opal **-JGBO**
- For colored LED jewel/guard assembly, order by suffixes:
 - Red **-LEDR**
 - Green **-LEDG**
 - Amber **-LEDA**
- Pilot light transformers for single pilot light per gang. Order by suffix:

Primary Voltage	Lamp Voltage	Suffix
220	120	TR-2
277	120	TR-3
440	120	TR-4
550	120	TR-5

- Securing rod for push button lockout guard. Add suffix **-SR**.
- **NPBRKT** nameplate mounting bracket to make circuit description/identification easy.
 - Pre-drilled holes in bottom of bracket allow direct mounting to control stations with existing cover bolts.
 - Pre-drilled holes in middle of bracket allow mounting of customer's circuit identification nameplate; epoxy glue may also be used for mounting (phenolic nameplate not included).
 - Bracket eliminates costly field installation of drilling and tapping to accommodate circuit identification nameplate.
 - Brackets fit side-by-side on 2-, 3- and 4-gang boxes and 3-devices.

NEC Certifications and Compliances

- UL Standards: UL 508, UL 698, UL 1203
- UL Listed: E10449, E81751

☉ For Class I, Division 1 applications, sealing fittings must be field installed adjacent to enclosure on all conduit runs.

① Teflon and Mylar are registered trademarks of E. I. du Pont de Nemours and Company.

Intraground™ N1 and N2 Series Control Stations

Nonmetallic

10 Ampere, 600 Vac Max. for Heavy Duty Use.

NEC — N1 Series (Non-Factory Sealed): Ⓞ
Class I, Division 1 and 2, Groups C, D
NEMA 3R, 4X, 7CD, 12

NEC — N2 Series (Factory Sealed):
Class I, Division 2, Groups B, C, D
Class II, Division 1 and 2, Groups E, F, G
Class III
NEMA 3R, 4X, 9EFG, 12

Illustrated Features



Aluminum grounding grid, imbedded into the nonmetallic enclosure during molding, provides complete grounding system. No field work. No extra grounding wires or parts required.

SPBB Design Features

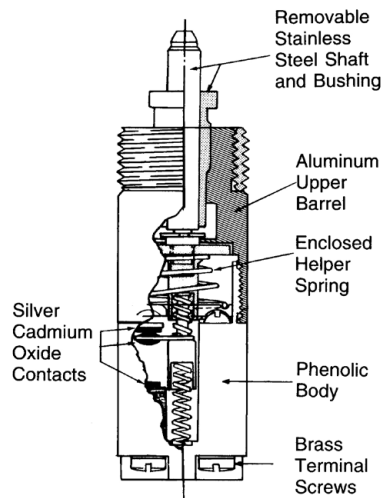

Ⓞ For Class I, Division 1 applications, sealing fittings must be field installed adjacent to enclosure on all conduit runs.

Intraground™ N1 and N2 Series Control Stations

Nonmetallic

10 Ampere, 600 Vac Max. for Heavy Duty Use.

NEC — N1 Series (Non-Factory Sealed): ☉
Class I, Division 1 and 2, Groups C, D
NEMA 3R, 4X, 7CD, 12

NEC — N2 Series (Factory Sealed):
Class I, Division 2, Groups B, C, D
Class II, Division 1 and 2, Groups E, F, G
Class III
NEMA 3R, 4X, 9EFG, 12

Catalog Numbering Guide

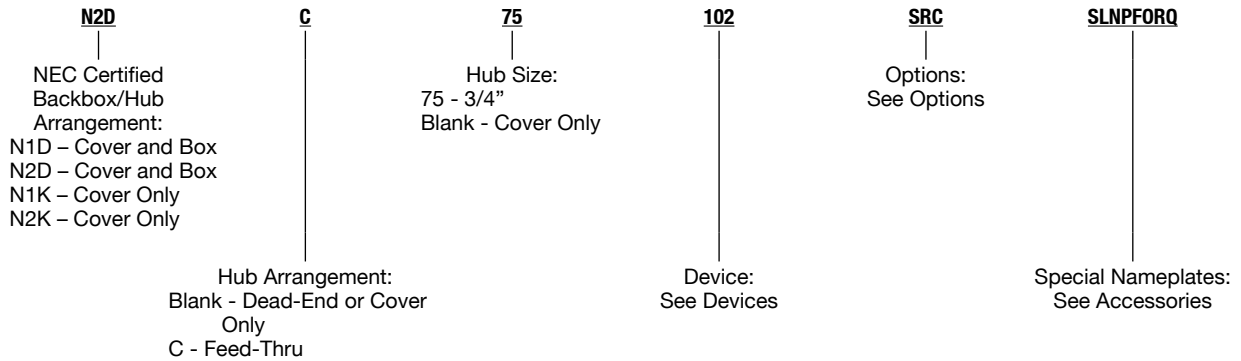

Full Catalog # N2DC75-102-SRC-SLNPFORQ

Feed-Thru N2D Box with 3/4" Hubs:
With A 2-Circuit, 3 Position
Spring Return from the Right
Selector Switch and "Forward-Off-Reverse" Nameplate

Options

Options Description	Suffix
Momentary Push Button Securing Rod	SR
Selector Switch Lockout	LD
Spring Return From Right Selector Switch (3 Positions Only)	SRC
Spring Return From Left Selector Switch (3 Positions Only)	SLC
Alternate Contacts Selector Switch	ALT
Change One Red Lens to Green Lens	JGBG
Change One Red Lens to Opal Lens	JGBO
Change One Red Lens to Amber Lens	JGBA
Change One Red Lens to Blue Lens	JGBB
Change One Red Lens to Clear Lens	JGBC
Add 220/120 Vac Transformer (J1 Device Only)	TR2
Add 277/120 Vac Transformer (J1 Device Only)	TR3
Add 440/120 Vac Transformer (J1 Device Only)	TR4
Add 550/120 Vac Transformer (J1 Device Only)	TR5
Change One Red Pilot to Red LED	LEDR
Change One Red Lens to Green LED	LEDG
Change One Red Lens to Amber LED	LEDA
Add Red Mushroom Head to Momentary Push Button	NMRBRE
Add Black Mushroom Head to Momentary Push Button	NMRBBL
Add Green Mushroom Head to Momentary Push Button	NMRBGR
Locking Guard for Maintained Push Button	SMPBLG

☉ For Class I, Division 1 applications, sealing fittings must be field installed adjacent to enclosure on all conduit runs.

Appleton

CONTROLS: NEC/CEC EXPLOSIONPROOF CONTROL STATIONS AND SWITCHES

Intraground™ N1 and N2 Series Control Stations Devices

Nonmetallic

NEC — N1 Series (Non-Factory Sealed): ☉
 Class I, Division 1 and 2, Groups C, D
 NEMA 3R, 4X, 7CD, 12

NEC — N2 Series (Factory Sealed):
 Class I, Division 2, Groups B, C, D
 Class II, Division 1 and 2, Groups E, F, G
 Class III
 NEMA 3R, 4X, 9EFG, 12

Devices

Device Description	Suffix
One Pilot Light (Red Standard)	J1
Two Pilot Lights	J2
One Pilot Light and One Momentary Push Button	J1U1
One Pilot Light and Two Momentary Push Buttons	J1U2
One Pilot Light and One Maintained Push Button	J1UM1
One Pilot Light and One Dust-Cap Push Button	J1DU1
One Pilot Light and One 12 Selector Switch (2 Position, 2 Circuit)	J112
One Pilot Light and One 35 Selector Switch (2 Position, 4 Circuit)	J135
One Pilot Light and One 102 Selector Switch (3 Position, 2 Circuit)	J1102
One Pilot Light and One 345 Selector Switch (3 Position, 4 Circuit)	J1345
One Monetary Push Button	U1
Two Monetary Push Buttons	U2
Two Side-By-Side Momentary Push Buttons	U2DBL
Three Monetary Push Buttons	U3
One Momentary Push Button and One Maintained Push Button	U1UM1
One Momentary Push Button and One Dust-Cap Push Button	U1DU1
One Momentary Push Button and One 12 Selector Switch (2 Position, 2 Circuit)	U112
One Momentary Push Button and One 35 Selector Switch (2 Position, 4 Circuit)	U135
One Momentary Push Button and One 102 Selector Switch (3 Position, 2 Circuit)	U1102
One Momentary Push Button and One 345 Selector Switch (3 Position, 4 Circuit)	U1345
One Maintained Push Button (Mushroom Head - Red)	UM1
Two Maintained Push Buttons	UM2
One Maintained and One Dust-Cap Push Button	UM1DU1
One Maintained Push Button and One 12 Selector Switch (2 Position, 2 Circuit)	UM112
One Maintained Push Button and One 35 Selector Switch (2 Position, 4 Circuit)	UM135
One Maintained Push Button and One 102 Selector Switch (3 Position, 2 Circuit)	UM1102
One Maintained Push Button and One 345 Selector Switch (3 Position, 4 Circuit)	UM1345
One Dust Cap Push Button	DU1
Two Dust Cap Push Buttons	DU2
One Dust Cap and One 12 Selector Switch (2 Position, 2 Circuit)	DU112
One Dust Cap and One 35 Selector Switch (2 Position, 4 Circuit)	DU135
One Dust Cap and One 102 Selector Switch (3 Position, 2 Circuit)	DU1102
One Dust Cap and One 345 Selector Switch (3 Position, 4 Circuit)	DU1345
One 12 Selector Switch (2 Position, 2 Circuit)	12
One 35 Selector Switch (2 Position, 4 Circuit)	35
One 102 Selector Switch (3 Position, 2 Circuit)	102
One 345 Selector Switch (3 Position, 4 Circuit)	345

☉ For Class I, Division 1 applications, sealing fittings must be field installed adjacent to enclosure on all conduit runs.

Intraground™ N1 and N2 Series Control Stations

Nonmetallic

10 Ampere, 600 Vac Max. for Heavy Duty Use. N1 Series – Neutral Color; N2 Series – Blue Color.

NEC — N1 Series (Non-Factory Sealed) : ☉
Class I, Division 1 and 2, Groups C, D
NEMA 3R, 4X, 7CD, 12

NEC — N2 Series (Factory Sealed):
Class I, Division 2, Groups B, C, D
Class II, Division 1 and 2, Groups E, F, G
Class III
NEMA 3R, 4X, 9EFG, 12

Nameplates ①

Description	Suffix	Description	Suffix
Mushroom Head Push Buttons (Maintained and Momentary)		Three Position Selection Switch Nameplates	
Start	MNPSTQ	Forward—Off—Reverse	SLNPFORQ
Stop	MNPSPQ	Hand—Off—Auto ②	SLNPHOAQ
Emergency Stop	MNPESTPQ	Run—Off—Jog	SLNPROJQ
Blank	MNPBQ	Blank	SLNPB3
Pilot Light Nameplates		Reverse—Off—Forward	SLNPROFQ
Blank	LNPBQ	Auto—Off—Hand	SLNPAOHQ
Forward	LNPFWQ	Hand—Off—Remote	SLNPHORQ
Jog	LNPJOGQ	1—Off—2	SLNP102Q
Run	LNPRUNQ	Jog—Off—Run	SLNPJORQ
Stop	LNPSQ	Stop—Run—Start	SLNPSRSQ
Start	LNPSTQ	Local—Off—Remote	SLNPLORQ
Down	LNPDOWNQ	Momentary Push Buttons	
Fast	LNPFQ	<i>For Rectangular Weatherboot Style Only (Not for round weatherboot style)</i>	
Slow	LNPSLOWQ	Blank ②	SNPBQ
Raise	LNPRAISEQ	Forward	SNPFWDQ
Lower	LNPLOWERQ	Jog	SNPJOGQ
Reset	LNPRESETQ	Run	SNPRUNQ
Off	LNPOFFQ	Stop ②	SNPSPQ
On	LNPONQ	Start ②	SNPSTQ
Reverse	LNPREVQ	Down	SNPDOWNQ
Close	LNPCLOSEQ	Fast	SNPFQ
Open	LNPOPENQ	Slow	SNPSLOWQ
Up	LNPUPQ	Raise	SNPRAISEQ
Test	LNPTSTQ	Lower	SNPLOWERQ
Low	LNPLOWQ	Reset	SNPRESETQ
High	LNPHIGHQ	Off	SNPOFFQ
Two Position Selection Switch Nameplates		On	SNPONQ
Forward—Reverse	SLNPFRQ	Reverse	SNPREVQ
Hand—Auto ②	SLNPHAQ	Close	SNPCLOSEQ
On—Off	SLNPOO	Open	SNPOPENQ
Start—Stop	SLNPSS	Up	SNPUPQ
Blank	SLNPBQ	Test	SNPTSTQ
Up—Down	SLNPUDQ	Low	SNPLOWQ
Run—Jog	SLNPRJQ	High	SNPHIGHQ
Auto—Hand	SLNPAHQ		
Off—Remote	SLNPORQ		

① Custom nameplates are not available.

② Included as standard (no need to use suffix).

☉ For Class I, Division 1 applications, sealing fittings must be field installed adjacent to enclosure on all conduit runs.

Intraground™ N1 and N2 Series Control Stations

Push Button and Push Button/Pilot Light. Nonmetallic

10 Ampere, 600 Vac Max. for Heavy Duty Use. N1 Series – Neutral Color; N2 Series – Blue Color.

NEC – N1 Series (Non-Factory Sealed): ☉
Class I, Division 1 and 2, Groups C, D
NEMA 3R, 4X, 7CD, 12

NEC – N2 Series (Factory Sealed):
Class I, Division 2, Groups B, C, D
Class II, Division 1 and 2, Groups E, F, G
Class III
NEMA 3R, 4X, 9EFG, 12

		Hub Size (Inches) ①	Description	Diagram	Nameplate Marking	Catalog Number	
						N1 Series ☉	N2 Series
1-Gang Push Buttons – Momentary Contact							
 1 Circuit	 2 Circuit	Dead-End					
		1/2 or 3/4	1 Circuit Universal		Start/Stop	N1D75-U1	N2D75-U1
		1/2 or 3/4	2 Circuits Universal		Start/Stop	N1D75-U2	N2D75-U2
		Feed-Thru					
		1/2 or 3/4	1 Circuit Universal		Start/Stop	N1DC75-U1	N2DC75-U1
		1/2 or 3/4	2 Circuits Universal		Start/Stop	N1DC75-U2	N2DC75-U2
1-Gang Push Buttons – Maintained Contact Red Mushroom Head – Emergency Stop Nameplate							
	Dead-End						
	1/2 or 3/4	1 Circuit Universal		Emergency Stop	N1D75-UM1	N2D75-UM1	
Feed-Thru							
		1/2 or 3/4	1 Circuit Universal		Emergency Stop	N1DC75-UM1	N2DC75-UM1
3-Device Push Buttons – Momentary Contact							
	Dead-End						
	1/2 or 3/4	3 Circuits Universal		Start/Stop	N1D75-U3	N2D75-U3	
Feed-Thru							
		1/2 or 3/4	3 Circuit Universal		Start/Stop	N1DC75-U3	N2DC75-U3
1-Gang Push Button/Pilot Light – Momentary Contact							
 1 Circuit 1 Pilot Light	 2 Circuit 1 Pilot Lights	Dead-End					
		1/2 or 3/4	1 Circuit Universal and 1 Pilot Light		Specify	N1D75-J1U1	N2D75-J1U1
		1/2 or 3/4	2 Circuits Universal and 1 Pilot Light		Specify	N1D75-J1U2	N2D75-J1U2
		Feed-Thru					
		1/2 or 3/4	1 Circuit Universal and 1 Pilot Light		Specify	N1DC75-J1U1	N2DC75-J1U1
		1/2 or 3/4	2 Circuits Universal and 1 Pilot Light		Specify	N1DC75-J1U2	N2DC75-J1U2
1-Gang Pilot Lights							
 1 Pilot Light	 2 Pilot Lights	Dead-End					
		1/2 or 3/4	1 Pilot Light		Specify	N1D75-J1	N2D75-J1
		1/2 or 3/4	2 Pilot Lights		Specify	N1D75-J2	N2D75-J2
		Feed-Thru					
		1/2 or 3/4	1 Pilot Light		Specify	N1DC75-J1	N2DC75-J1
		1/2 or 3/4	2 Pilot Lights		Specify	N1DC75-J2	N2DC75-J2

① Furnished with 3/4" to 1/2" NPT reducer.

☉ For Class I, Division 1 applications, sealing fittings must be field installed adjacent to enclosure on all conduit runs.

































Intraground™ N1 and N2 Series Control Stations

Selector Switch Control Stations and Fire Alarm Station. Nonmetallic





10 Ampere, 600 Vac Max. for Heavy Duty Use. N1 Series – Neutral Color; N2 Series – Blue Color.

NEC – N1 Series (Non-Factory Sealed): ☉
Class I, Division 1 and 2, Groups C, D
NEMA 3R, 4X, 7CD, 12

NEC – N2 Series (Factory Sealed):
Class I, Division 2, Groups B, C, D
Class II, Division 1 and 2, Groups E, F, G
Class III
NEMA 3R, 4X, 9EFG, 12

	Hub Size (Inches) ①	Pilot Light Diagram	Switch Diagram			Catalog Number	
			Left	Center	Right	With Pilot Light	With Out Pilot Light
Dead-End							
	1/2 or 3/4 — Pilot Light and 2-Pos., 2-Cir. Selector Switch			None		N1D75-J112	N1D75-12
						N2D75-J112	N2D75-12
	1/2 or 3/4 — Pilot Light and 2-Pos., 4-Cir. Selector Switch			None		N1D75-J135	N1D75-35
						N2D75-J135	N2D75-35
<i>Note: Standard legend plate reads Hand/Auto</i>							
	1/2 or 3/4 — Pilot Light and 3-Pos., 2-Cir. Selector Switch					N1D75-J1102	N1D75-102
						N2D75-J1102	N2D75-102
	1/2 or 3/4 — Pilot Light and 3-Pos., 4-Cir. Selector Switch					N1D75-J1345	N1D75-345
						N2D75-J1345	N2D75-345
<i>Note: Standard legend plate reads Hand/Off/Auto</i>							
Feed-Thru							
	1/2 or 3/4 — Pilot Light and 2-Pos., 2-Cir. Selector Switch			None		N1DC75-J112	N1DC75-12
						N2DC75-J112	N2DC75-12
	1/2 or 3/4 — Pilot Light and 2-Pos., 4-Cir. Selector Switch			None		N1DC75-J135	N1DC75-35
						N2DC75-J135	N2DC75-35
<i>Note: Standard legend plate reads Hand/Auto</i>							
	1/2 or 3/4 — Pilot Light and 3Pos., 2-Cir. Selector Switch					N1DC75-J1102	N1DC75-102
						N2DC75-J1102	N2DC75-102
	1/2 or 3/4 — Pilot Light and 3-Pos., 4-Cir. Selector Switch					N1DC75-J1345	N1DC75-345
						N2DC75-J1345	N2DC75-345
<i>Note: Standard legend plate reads Hand/Off/Auto</i>							

Fire Alarm Station, Factory Sealed – Universal Contacts, with hammer on chain

	Hub Size (Inches) ①	Description	Catalog Number	
			N1 Series ☉ (Neutral Color)	N2 Series (Red Color)
Dead-End				
	1/2 or 3/4	Universal 2 Position, 1 Circuit		
			N1D75FA-U1	N2D75FA-U1
Feed-Thru				
	1/2 or 3/4	Universal 2 Position, 1 Circuit		
			N1DC75FA-U1	N2DC75FA-U1
Replacement Glass				
(For N1 or N2)			NFA-G	

① Furnished with a 3/4" to 1/2" NPT reducer.

☉ For Class I, Division 1 applications, sealing fittings must be field installed adjacent to enclosure on all conduit runs. Do not use in atmospheres containing electrically conductive dusts (most coal dusts are not electrically conductive).

Intraground™ N1 and N2 Series Control Stations

Selector Switch Operators and Cover Assemblies. Nonmetallic

For use with N1 and N2 Series Bodies Only. 10 Ampere, 600 Vac Max. for Heavy Duty Use. N1 Series – Neutral Color; N2 Series – Blue Color.

NEC – N1 Series (Non-Factory Sealed): ☉
Class I, Division 1 and 2, Groups C, D
NEMA 3R, 4X, 7CD, 12

NEC – N2 Series (Factory Sealed):
Class I, Division 2, Groups B, C, D
Class II, Division 1 and 2, Groups E, F, G
Class III
NEMA 3R, 4X, 9EFG, 12

Appleton

CONTROLS: NEC/CEC EXPLOSIONPROOF CONTROL STATIONS AND SWITCHES

Thread Size (Inches, NPSM)	Description	Left	Diagram Center	Right	N1/N2 Switch Assembly Only	Assembly with Cover N1 Switch	N2 Switch
Maintained Contact							
1/2	2 Position, 2 Circuit				SSBA1-2Q	N1K-12	N2K-12
1/2	2 Position, 4 Circuit				SSBA2-2Q	N1K-35	N2K-35
<i>Note: Standard legend plate reads Hand/Auto</i>							
1/2	3 Position, 2 Circuit				SSBA1-3Q	N1K-102	N2K-102
1/2	3 Position, 4 Circuit				SSBA2-3Q	N1K-345	N2K-345
<i>Note: Standard legend plate reads Hand/Off/Auto</i>							
Modified Operations							
2 Circuit (2 or 3 Position)							
Momentary contact right position. Spring return to center. Maintained contact left position.							
1/2	3 Position, 2 Circuit				SSBAS-1-3	N1K-102SRC	N2K-102SRC
1/2	3 Position, 4 Circuit				SSBAS-2-3	N1K-345SRC	N2K-345SRC
<i>Note: Standard legend plate reads Hand/Off/Auto</i>							
Momentary contact left position. Spring return to center. Maintained contact right position.							
1/2	3 Position, 2 Circuit				SSBASL-1-3	N1K-102SLC	N2K-102SLC
1/2	3 Position, 4 Circuit				SSBASL-2-3	N1K-345SLC	N2K-345SLC
<i>Note: Standard legend plate reads Auto/Off/Hand</i>							
Momentary contact right position. Spring return to center. Maintained contact left position.							
1/2	3 Position, 4 Circuit				SSBASRA-2-3	N1K-637SRC	N2K-637SRC
<i>Note: Standard legend plate reads Stop/Run/Start</i>							

Nameplates



Two Position



Three Position

	Two Position Nameplates	Three Position Nameplates
Forward—Reverse	SLNP-FRQ	Forward—Off—Reverse SLNP-FORQ
Hand—Auto ☉	SLNP-HAQ	Hand—Off—Auto ☉ SLNP-HOAQ
On—Off	SLNP-OO	Run—Off—Jog SLNP-ROJQ
Start—Stop	SLNP-SS	Blank SLNP-B3
Blank	SLNP-BQ	Reverse—Off—Forward SLNP-ROFQ
Up—Down	SLNP-UDQ	Auto—Off—Hand SLNP-AOHQ
Run—Jog	SLNP-RJQ	Hand—Off—Remote SLNP-HORQ
Auto—Hand	SLNP-AHQ	1—Off—2 SLNP-1O2Q
Off—Remote	SLNP-ORQ	Jog—Off—Start SLNP-JORQ
		Stop—Run—Start SLNP-SRSQ
		Local—Off—Remote SLNP-LORQ

Selector Switch Locking Devices



Two or Three Positions — Permit locking in any position.

SBL-3-Q

☉ Supplied as standard with Maintained Contact Selector Switches.

☉ For Class I, Division 1 applications, sealing fittings must be field installed adjacent to enclosure on all conduit runs.

Intraground™ N1 and N2 Series Control Stations



Nonmetallic.

For use with N1 and N2 Series Bodies Only. All Covers Supplied with Four Bolts and Blank Nameplate. N1 Series– Neutral Color; N2 Series– Blue Color.

NEC – N1 Series (Non-Factory Sealed): ☉
Class I, Division 1 and 2, Groups C, D
NEMA 3R, 4X, 7CD, 12

NEC – N2 Series (Factory Sealed):
Class I, Division 2, Groups B, C, D
Class II, Division 1 and 2, Groups E, F, G
Class III
NEMA 3R, 4X, 9EFG, 12

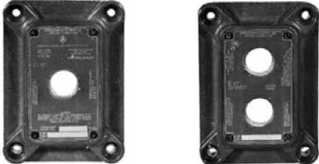
Covers Only – for Use with Nonmetallic Mounting Bodies Below

	Description	Catalog Number	
		N1 Series	N2 Series
	Pilot Light or Push Button Covers 3/4" tapped openings One opening: one pilot light or one push button ☉	N1K-1PL	N2K-1PL
	Two openings: two pilot lights; two push buttons – one pilot light and one push button ☉	N1K-2PL	N2K-2PL
	Push Button or Selector Switch Covers 1/2" tapped openings Two openings: selector switch or two push buttons	N1K-2SP	N2K-2SP
	Push Button, Pilot light or Selector Switch Covers One 3/4" top and two 1/2" bottom tapped openings One top and two bottom openings – one pilot light, two push buttons; one pilot light, one selector switch; or three push buttons ☉	N1K-3JPB	N2K-3JPB

1-Gang Nonmetallic Mounting Bodies – for use with Covers Above

	Description	Hub Size (Inches) ☉	Catalog Number	
			N1 Series	N2 Series
	Dead-End	1/2 or 3/4	N1D75Q	N2D75Q
	Feed-Thru	1/2 or 3/4	N1DC75Q	N2DC75Q

Nameplate Mounting Bracket

Description	Catalog Number
 <p>Bracket for N1, N2 Series</p> <p>To order bracket with control station, add suffix -NPBRKT to end of catalog number.</p> <p><i>Note: Secure mount bracket using cover nameplate screws.</i></p>	NPBRKT-N1N2

☉ Furnished with 3/4" to 1/2" NPSM reducer.

☉ Furnished with a 3/4" to 1/2" NPT reducer.

☉ For Class I, Division 1 applications, sealing fittings must be field installed adjacent to enclosure on all conduit runs.











Intraground™ N1 and N2 Series Control Stations

Nonmetallic

10 Ampere, 600 Vac Max. for Heavy Duty Use. N1 Series – Neutral Color; N2 Series – Blue Color.

NEC:

Class I, Division 1 and 2, Groups B*, C, D
Class II, Division 1 and 2, Groups E, F, G
Class III

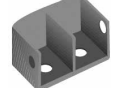
Description		Diagram	Catalog Number	
Push Button – Factory Sealed – Momentary Contact				
	<i>10 Amp 600 Vac Heavy Duty 1/2" thread size (NPSM). Furnished with 1/2" to 3/4" enlarger; Weather Boot, Guard, Start, Stop and Blank Nameplates.</i>			
SPBB-U1-Q	Single Push Button	Universal		SPBB-U1-Q
				
SPBB-U2DBL	Double Push Button	Universal		SPBB-U2DBL
Push Button – Red Mushroom Head – Factory Sealed – Maintained Contact				
	<i>10 Amp 600 Vac Heavy Duty 1/2" thread size (NPSM). Furnished with 1/2" to 3/4" enlarger and Emergency Stop Nameplate (guard not furnished).</i>			
	Single Push Button	Universal		SMPB-U1-Q
Rectangular Button with Weather Boot				
	Furnished with Start, Stop and Blank Nameplates			
				NBN-WB
Nameplates for Rectangular Push Buttons				
	Blank	SNP-B-Q	Off	SNP-OFF-Q
	Forward	SNP-FWD-Q	On	SNP-ON-Q
	Jog	SNP-JOG-Q	Reverse	SNP-REV-Q
	Run	SNP-RUN-Q	Open	SNP-OPEN-Q
SNP-OFF-Q	Stop	SNP-SP-Q	Close	SNP-CLOSE-Q
	Start	SNP-ST-Q	Up	SNP-UP-Q
	Down	SNP-DOWN-Q	Test	SNP-TEST-Q
	Fast	SNP-FAST-Q	Low	SNP-LOW-Q
	Slow	SNP-SLOW-Q	High	SNP-HIGH-Q
	Raise	SNP-RAISE-Q		
SNP-ON-Q	Lower	SNP-LOWER-Q		
	Reset	SNP-RESET-Q		
Push Button Replacement Locking Guards – Glass Reinforced Polypropylene – Gasketed				
	Maintained Mushroom Head Switch Guard	<i>Has hole for 1/4" hasp.</i>		
	Single Guard (Maintained Switch)			SMPB-LG
	Single Guard			NPB-LG1
	Double Guard			NPB-LG2
	Single Guard (No Lockout Holes)			NPB-LG1-LL
	Double Guard (No Lockout Holes)			NPB-LG2-LL

♦ Suitable for Class I, Group B when installed in an enclosure rated for Class I, Group B.

Intraground™ N1 and N2 Series Control Station

Nonmetallic

10 Ampere, 600 Vac Max. for Heavy Duty Use. N1 Series – Neutral Color; N2 Series – Blue Color.

NEC:

Class I, Division 1 and 2, Groups B*, C, D
 Class II, Division 1 and 2, Groups E, F, G
 Class III

Push Button Accessories and Parts

Description	Catalog Number
-------------	----------------

Push Button Securing Rod with Chain – Stainless Steel

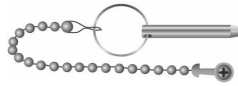

For use with Single Guard Only

NBL-SR

Mushroom Head Button with Weather Boot for Use with Momentary Contact – Gasketed



Black
 Green
 Red

NMRB-BL
 NMRB-GR
 NMRB-RE

Mushroom Head Push Button



For Use with Mushroom Head Push Button – Maintained Contact – Solid-Colored Nonmetallic
 Red

NMRBM-RE



MNPESTPQ

Nameplates – Mushroom Head Push Button For Momentary and Maintained

Start	MNPSTQ
Stop	MNPSPQ
Emergency Stop	MNPESTPQ
Blank	MNPBQ

Pilot Light, Factory Sealed



Pilot Light



Chamber Only

Incandescent

Furnished with 6S6 120 Vac incandescent lamp, jewel and guard. Has 457 mm (18") long, type SFF-2 pigtail leads; +150 °C (+302 °F). Body has 3/4" straight thread (NPSM).

With Red Jewel	SPLSREB
With Green Jewel	SPLSGRB
With Amber Jewel	SPLSAMB
With Blue Jewel	SPLSBLB
With Clear Jewel	SPLSCLB
With Opal Jewel	SPLSOPB

LED

Furnished with candelabra base 120 Vac LED, jewel and guard. Has 457 mm (18") long, type SFF-2 pigtail leads; +150 °C (+302 °F). Body has 3/4" straight thread (NPSM).

With Red LED, Clear Jewel	SPLNSREB
With Green LED, Clear Jewel	SPLNSGRB
With Amber LED, Clear Jewel	SPLNSAMB

Chamber Only (Same as above, less jewel, guard and lamp) SPLSSCB

♦ Suitable for Class I, Group B when installed in an enclosure rated for Class I, Group B.

Intraground™ N1 and N2 Series Control Stations

Nonmetallic

10 Ampere, 600 Vac Max. for Heavy Duty Use. N1 Series – Neutral Color; N2 Series – Blue Color.

NEC:

Class I, Division 1 and 2, Groups B*, C, D
Class II, Division 1 and 2, Groups E, F, G
Class III

Push Button Accessories and Parts

Description	Catalog Number
-------------	----------------

Pilot Light Jewel/Guard Assembly

The below catalog numbers indicate an assembly of the Pilot Light Jewels and Guards. Jewels and Guards are not available as separate items.



Amber Jewel/Guard	JGBNA
Blue Jewel/Guard	JGBNB
Clear Jewel/Guard	JGBNC
Green Jewel/Guard	JGBNG
Opal Jewel/Guard	JGBNO
Red Jewel/Guard	JGBNR

Replacement Bulbs



EPL-B6W



EPLLEDR

Clear Bulbs

Furnished with candelabra base. 6 Watt, 120 Vac, Type 6S6

EPL-B6W

LED Replacements

Furnished with candelabra base. 120 Vac, 10 mA.

Red LED	EPLLEDR
Green LED	EPLLEDG
Amber LED	EPLLEDA

Transformer

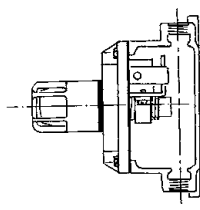

Add Suffix as listed below. Transformer clamps directly to pilot light barrel.
Only one pilot light transformer assembly per one gang body.

Primary Vac	Lamp Vac	Suffix
220	120	TR2
277	120	TR3
440	120	TR4
550	120	TR5

Nameplates for Pilot Light



LNPRUNQ

Description	Catalog Number	Description	Catalog Number
Blank	LNPBQ	Reset	LNPRESETQ
Forward	LNPFDQ	Off	LNPOFFQ
Jog	LNPJOGQ	On	LNPONQ
Run	LNPRUNQ	Reverse	LNPREVQ
Stop	LNPSPQ	Close	LNPCLOSEQ
Start	LNPSTQ	Open	LNPOPENQ
Down	LNPDOWNQ	Up	LNPUPQ
Fast	LNPFASTQ	Test	LNPTSTQ
Slow	LNPSLOWQ	Low	LNPLOWQ
Raise	LNPRAISEQ	High	LNPHIGHQ
Lower	LNPLOWERQ		

♦ Suitable for Class I, Group B when installed in an enclosure rated for Class I, Group B.

Intraground™ N1 and N2 Series Control Stations

NEC — N1 Series (Non-Factory Sealed): ☉
 Class I, Division 1 and 2, Groups C, D
 NEMA 3R, 4X, 7CD, 12

NEC — N2 Series (Factory Sealed):
 Class I, Division 2, Groups B, C, D
 Class II, Division 1 and 2, Groups E, F, G
 Class III
 NEMA 3R, 4X, 9EFG, 12

Dimensions in Millimeters (Inches)

Push Button/Pilot Light

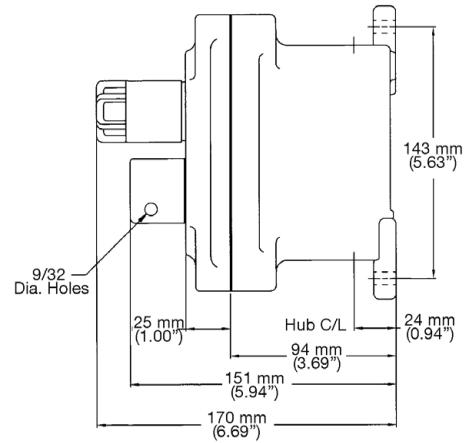
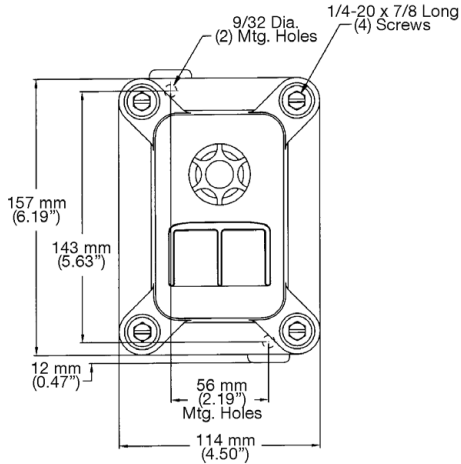

Selector Switch

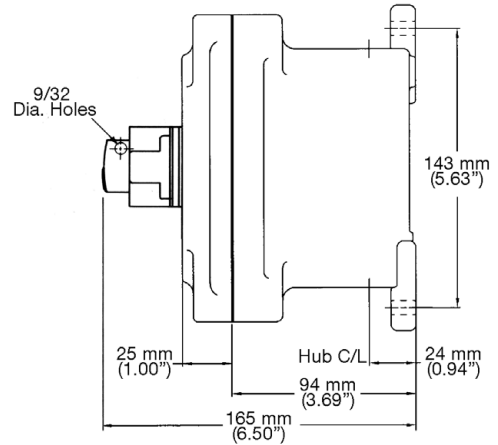
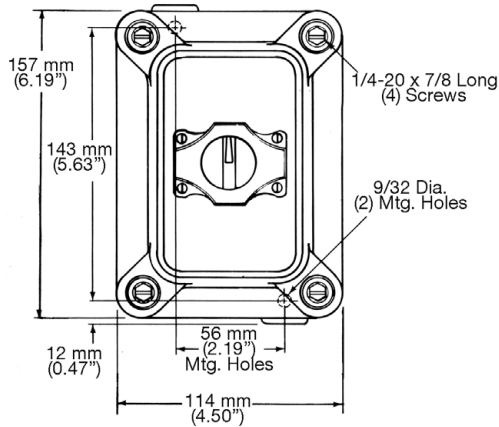

NPBRKT Nameplate Mounting Bracket

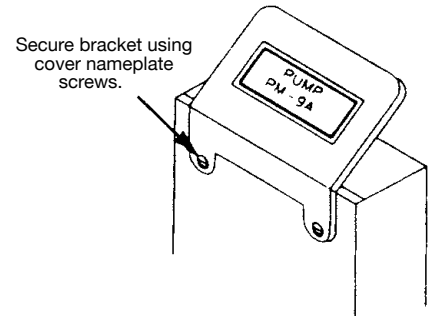
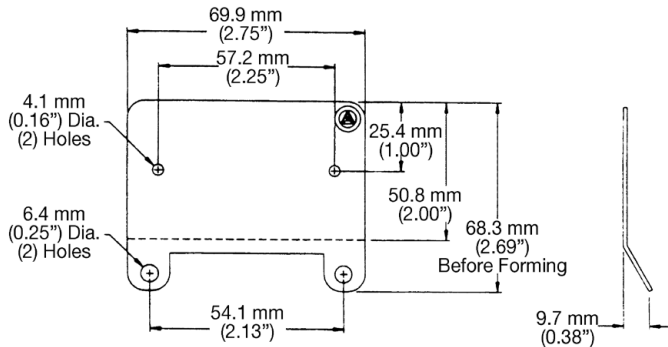

☉ For Class I, Division 1 applications, sealing fittings must be field installed adjacent to enclosure on all conduit runs.