

ATX™ PRE Series 63 Amp Plugs and Sockets

Increased Safety

ATEX/IECEX:
Zone 1 and 2 - 21 and 22
Ⓜ II 2 GD
IP66 - IK10

Applications

- Plugs and sockets are used with stationary or portable electrically operated devices such as:
 - Welding devices
 - Lighting systems
 - Conveyors
 - Heaters
 - Motor generator sets
 - Air conditionings
 - Compressors
 - Pumps
- For use in corrosive atmospheres and installations in Zones 1, and 2 and 21 and 22 of oil and gas industry, such as
 - Refineries
 - Chemical and petrochemical plants
 - Pipelines
 - Onshore and offshore drilling platforms

Features

- Positive polarization: only ATX plugs of same style, number of poles and ampere rating may be used with these sockets.
- Interlocked 3-pole or 4-pole Ex de disconnecting on-load switch, with auxiliary early break contact capacity 2.5 mm² (0.004 in²) max .
- Plug is mechanically locked in socket when switch is "ON".
- Switch operating handle can be padlocked in "OFF" position (max 4 padlocks).
- Plug cannot be inserted or removed unless switch is in "OFF" position.

Standard Materials

- Socket: high impact resistance fiberglass reinforced polyester
- Flap cover and plug: polyamide

ATEX/IECEX Certifications and Compliances

- Certification Type PC63X
 - Gas: Zones 1 and 2
 - Conforming to 2014/34/UE: Ⓜ II 2 G
 - Type of Protection: Ex de IIC
 - Temperature Class: T6 for Ta ≤ +40 °C (+104 °F) and T5 for +55 °C (+131 °F)
 - Dust: Zones 21 and 22
 - Conforming to 2014/34/EU: Ⓜ II 2 D
 - Type of Protection: Ex tD A21
 - Surface Temperature: T90 °C (T194 °F)
- Ambient Temperature: -30 °C to +55 °C (-22 °F to +131 °F)
- Index of Protection according EN/IEC 60529: IP66
- Impact Resistance (shock): IK10
- EU Declaration of Conformity: 50208
- ATEX Certificate: LCIE 99 ATEX 6004
- IECEX Certificate: IECEX LCIE 13.0010

EURASEC Certification

- EURASEC N° TC RU C-FR.Γ505.B.00910

Other Certification

- INMETRO Certificate: BVC11.0595 ①

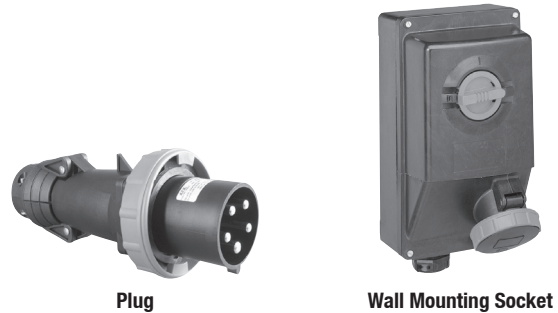

Plug

Wall Mounting Socket

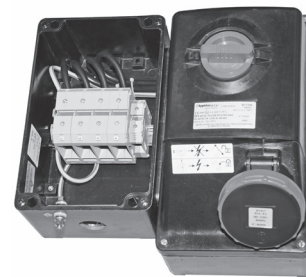

Wall Mounting Socket Through-Wired

PLUGS AND RECEPTACLES: ATEX/IECEX INCREASED SAFETY

① INMETRO certification available on special request only. Contact your local sales representative for more information.

ATX™ PRE Series 63 Amp Plugs and Sockets

Increased Safety

ATEX/IECEX:
 Zone 1 and 2 - 21 and 22
 II 2 GD
 IP66 - IK10



Wall Mounting Socket

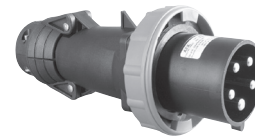

Plug

- Standard versions:
 - Supplied with one M50 cable gland for unarmored cable – Ø 28 to Ø 42 mm (Ø 1.10 to Ø 1.65”) and one M25 blanking plug.
 - Terminal capacity 1 x 25 mm² (0.002 x 0.039 in²).
- Through-wired versions:
 - Supplied with two M50 cable glands for unarmored cable – Ø 28 to Ø 42 mm (Ø 1.10 to Ø 1.65”) and one M25 blanking plug.
 - Terminal capacity 2 x 25 mm² (0.003 x 0.039 in²).
- One integrated cable entry for unarmored flexible cable – Ø 17.5 to Ø 29 mm (Ø 0.69 to Ø 1.14”) for 3P + E versions; Ø 17.5 to Ø 32 mm (Ø 0.69 to Ø 1.26”) for 3P + N + E versions.
- Terminal capacity 16 mm² (0.025 in²).

PLUGS AND RECEPTACLES: ATEX/IECEX INCREASED SAFETY

63 Amps		
Main Contacts		
Rated Insulation Voltage	690 Vac	
Rated Operating Voltage	690 Vac	
Rated Operating Current	63 Amp	
Rated Surge Voltage	6 KV	
Switching Capacity		
AC 21 A / AC 22 A	63 Amp	230 Volt to 690 Volt
	15 kW	230 Volt
	22 kW	400 Volt
AC 23 A	30 kW	500 Volt
	18.5 kW	690 Volt
	11 kW	230 Volt
	18.5 kW	400 Volt
AC 3	22 kW	500 Volt
	15 KW	690 Volt
DC 21	–	
DC 22	–	
DC 23	–	
Auxiliary Contacts		
Rated Insulation Voltage	400 Volt	
Rated Operating Voltage	400 Volt	
Rated Operating Current	10 Amp	
Switching Capacity: AC 15	6 Amp	230 Volt
	4 Amp	400 Volt
Others		
Termination (flexible/solid)	25 mm ² (0.039 in ²)	

ATX™ PRE Series 63 Amp Plugs and Sockets

Increased Safety

ATEX/IECEX:
 Zone 1 and 2 - 21 and 22
 II 2 GD
 IP66 - IK10

Catalog Numbering Guide – IECEx Internationally Certified Plugs and Receptacles

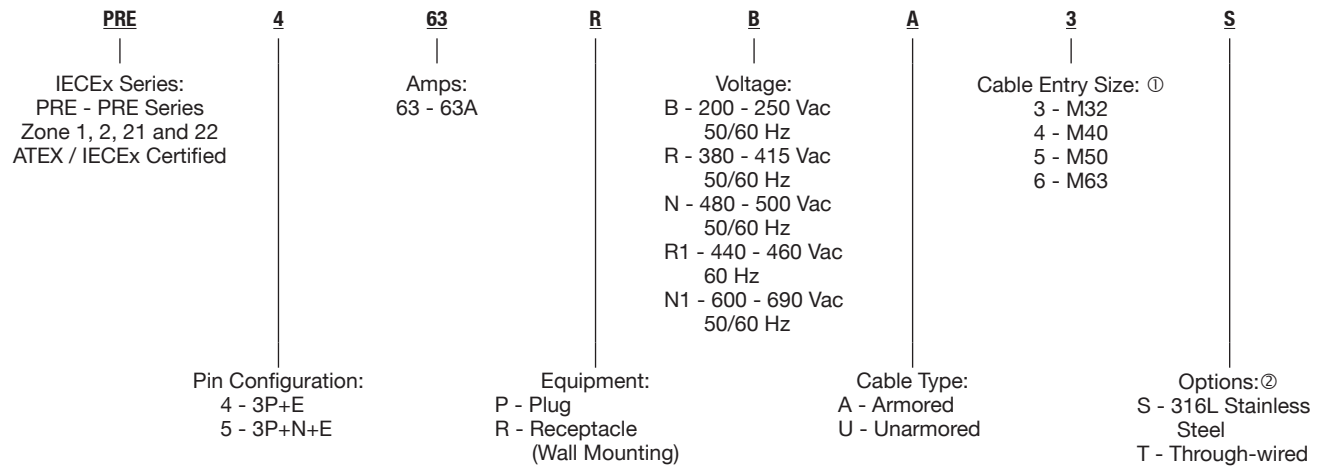

LV: Low Voltage

Blue	Red	Black	Red 1	Black 1
200/250 Vac	380/415 Vac	480/500 Vac	440/460 Vac	600/690 Vac

PLUGS AND RECEPTACLES: ATEX/IECEX INCREASED SAFETY

① With one M25 plugged entry.



② 316L stainless steel option is NOT certified

ATX™ PRE Series 63 Amp Plugs and Sockets

Increased Safety

ATEX/IECEX:
 Zone 1 and 2 - 21 and 22
 II 2 GD
 IP66 - IK10

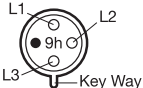
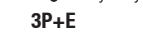
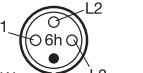
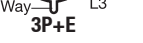
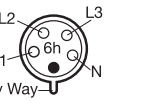
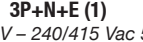
Standard Versions

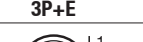
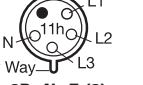
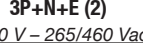
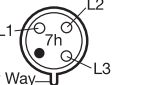
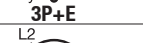
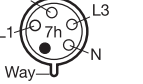
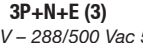
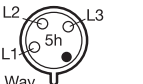
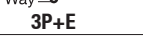
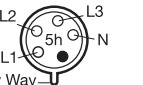
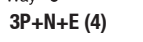
Description	Pin Configuration	Weight kg (lb)	Volume dm ³ (in ³)	Catalog Number
200/250 Vac 50/60 Hz – Blue				
Wall Socket		8.0 (17.64)	26.0 (1586.62)	PRE463RBU5
Plug	 3P+E	1.0 (2.20)	7.0 (427.17)	PRE463PB
380/415 Vac 50/60 Hz – Red				
Wall Socket		8.0 (17.64)	26.0 (1586.62)	PRE463RRU5
Plug	 3P+E	1.0 (2.20)	7.0 (427.17)	PRE463PR
Wall Socket		8.0 (17.64)	26.0 (1586.62)	PRE563RRU5
Plug	 3P+N+E (1) (1) 200/346 V – 240/415 Vac 50/60 Hz	1.0 (2.20)	7.0 (427.17)	PRE563PR
440/460 Vac 60 Hz – Red				
Wall Socket		8.0 (17.64)	26.0 (1586.62)	PRE463RR1U5
Plug	 3P+E	1.0 (2.20)	7.0 (427.17)	PRE463PR1
Wall Socket		8.0 (17.64)	26.0 (1586.62)	PRE563RR1U5
Plug	 3P+N+E (2) (2) 250/440 V – 265/460 Vac 60 Hz	1.0 (2.20)	7.0 (427.17)	PRE563PR1
480/500 Vac 50/60 Hz – Black				
Wall Socket		8.0 (17.64)	26.0 (1586.62)	PRE463RNU5
Plug	 3P+E	1.0 (2.20)	7.0 (427.17)	PRE463PN
Wall Socket		8.0 (17.64)	26.0 (1586.62)	PRE563RNU5
Plug	 3P+N+E (3) (3) 277/480 V – 288/500 Vac 50/60 Hz	1.0 (2.20)	7.0 (427.17)	PRE563PN
600/690 Vac 50/60 Hz – Black				
Wall Socket		8.0 (17.64)	26.0 (1586.62)	PRE463RN1U5
Plug	 3P+E	1.0 (2.20)	7.0 (427.17)	PRE463PN1
Wall Socket		8.0 (17.64)	26.0 (1586.62)	PRE563RN1U5
Plug	 3P+N+E (4) (4) 347/600 V – 400/690 Vac 50/60 Hz	1.0 (2.20)	7.0 (427.17)	PRE563PN1

PLUGS AND RECEPTACLES: ATEX/IECEX INCREASED SAFETY

ATX™ PRE Series 63 Amp Plugs and Sockets

Increased Safety

ATEX/IECEX:
 Zone 1 and 2 - 21 and 22
 II 2 GD
 IP66 - IK10

Through-Wired Versions

Description	Pin Configuration	Weight kg (lb)	Volume dm ³ (in ³)	Catalog Number
380/415 Vac 50/60 Hz – Red				
Wall Socket		16.0 (35.27)	110.0 (6712.61)	PRE463RRU5T
Wall Socket		16.0 (35.27)	110.0 (6712.61)	PRE563RRU5T
(1) 200/346 V – 240/415 Vac 50/60 Hz				

Dimensions in Millimeters (Inches)

Standard Version

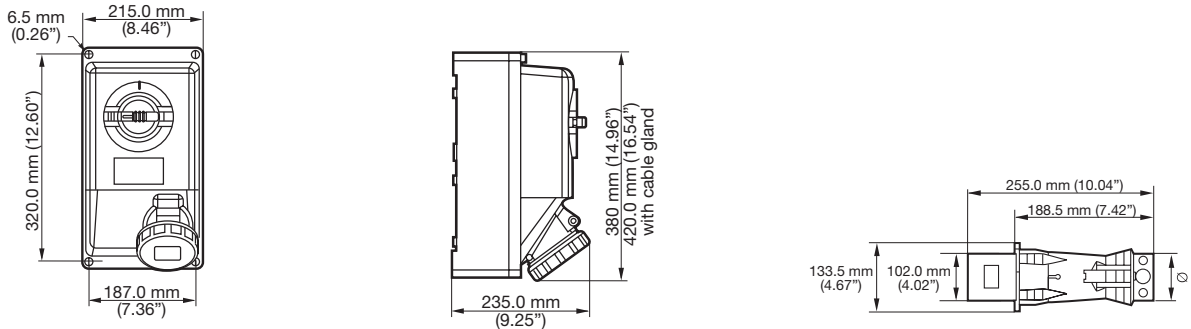

Through-Wired Version

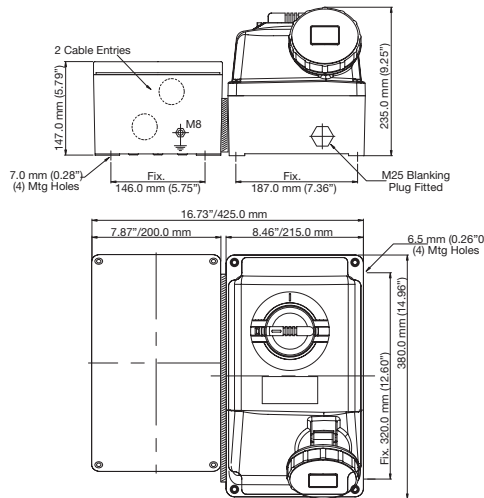

PLUGS AND RECEPTACLES: ATEX/IECEX INCREASED SAFETY