

User Guide

Vaisala HUMICAP[®] Humidity and
Temperature Probes

HMP4, HMP5, HMP7, HMP8, TMP1

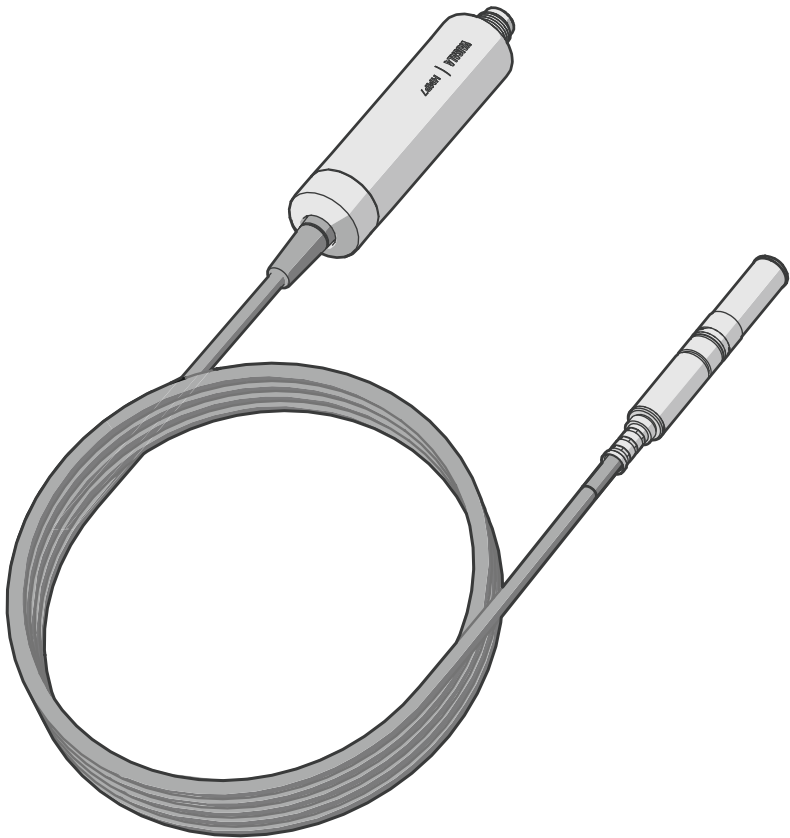

VAISALA

PUBLISHED BY

Vaisala Oyj
Vanha Nurmijärventie 21, FI-01670 Vantaa, Finland
P.O. Box 26, FI-00421 Helsinki, Finland
+358 9 8949 1

Visit our Internet pages at www.vaisala.com.

© Vaisala Oyj 2018

No part of this manual may be reproduced, published or publicly displayed in any form or by any means, electronic or mechanical (including photocopying), nor may its contents be modified, translated, adapted, sold or disclosed to a third party without prior written permission of the copyright holder. Translated manuals and translated portions of multilingual documents are based on the original English versions. In ambiguous cases, the English versions are applicable, not the translations.

The contents of this manual are subject to change without prior notice.

Local rules and regulations may vary and they shall take precedence over the information contained in this manual. Vaisala makes no representations on this manual's compliance with the

local rules and regulations applicable at any given time, and hereby disclaims any and all responsibilities related thereto.

This manual does not create any legally binding obligations for Vaisala towards customers or end users. All legally binding obligations and agreements are included exclusively in the applicable supply contract or the General Conditions of Sale and General Conditions of Service of Vaisala.

This product contains software developed by Vaisala or third parties. Use of the software is governed by license terms and conditions included in the applicable supply contract or, in the absence of separate license terms and conditions, by the General License Conditions of Vaisala Group.

Table of Contents

1.	About This Document	5
1.1	Version Information.....	5
1.2	Related Manuals.....	5
1.3	Documentation Conventions.....	5
1.4	Trademarks.....	6
2.	Product Overview	7
2.1	Probe Structure.....	7
2.2	Basic Features and Options.....	7
2.3	Additional Features with Indigo Transmitters.....	8
2.4	Safety.....	8
2.5	ESD Protection.....	9
2.6	HMP4 Probe.....	9
2.7	HMP5 Probe.....	9
2.8	HMP7 Probe.....	10
2.9	HMP8 Probe.....	11
2.10	TMP1 Probe.....	12
3.	Installation	13
3.1	Probe Body Dimensions and Pinout.....	14
4.	Configuration with Insight Software	15
4.1	Vaisala Insight Software.....	15
4.2	Connecting to Insight Software.....	15
4.3	Configuration Options.....	16
5.	Using Probe with Indigo Transmitters	17
5.1	Indigo Overview.....	17
5.2	Attaching Probes to Indigo Transmitters.....	19
5.3	Wireless Configuration Interface Overview.....	19
5.4	Connecting to Wireless Configuration Interface.....	20
5.5	Logging in to Wireless Configuration Interface.....	21
6.	Maintenance	22
6.1	Cleaning the Probe.....	22
6.1.1	Chemical Tolerance.....	22
6.2	Changing the Probe Filter.....	23
6.3	Calibration and Adjustment.....	23
6.3.1	Adjustment Points and Requirements.....	24
6.3.2	Adjusting Measurement using Insight Software.....	24

7.	Technical Data	26
7.1	HMP4 Specifications.....	26
7.2	HMP5 Specifications.....	28
7.3	HMP7 Specifications.....	31
7.4	HMP8 Specifications.....	34
7.5	TMP1 Specifications.....	36
7.6	Dimensions.....	38
7.7	Spare Parts and Accessories.....	40
Appendix A:	Modbus Reference	45
A.1	Default Communication Settings.....	45
A.2	Function Codes.....	45
A.3	Data Encoding.....	45
A.3.1	32-Bit Floating Point or Integer Format.....	46
A.3.2	16-Bit Integer Format.....	46
A.4	Modbus Registers.....	46
A.4.1	Measurement Data Registers.....	47
A.4.2	Configuration Registers.....	49
A.4.3	Device Identification Objects.....	51
A.4.4	Test Value Registers.....	52
A.4.5	Modbus Communication Examples.....	53
Online Store		57
Warranty		57
Technical Support		57
Recycling		57

List of Figures

Figure 1	Probe Parts.....	7
Figure 2	HMP4 Probe Head Dimensions.....	9
Figure 3	HMP5 Probe Head Dimensions.....	9
Figure 4	Optional Mounting Flange 210696 Dimensions.....	10
Figure 5	HMP7 Probe Head Dimensions.....	10
Figure 6	HMP8 Probe Head Dimensions.....	11
Figure 7	Optional Ball Valve Installation Kit Dimensions.....	11
Figure 8	TMP1 Probe Head Dimensions.....	12
Figure 9	Example Installation of HMP8 Model.....	13
Figure 10	Probe Body.....	14
Figure 11	Connecting Probe to Insight.....	15
Figure 12	HMP in Insight Software.....	16
Figure 13	HMP7 Attached to Indigo 200 Transmitter.....	17
Figure 14	HMP7 Attached to Indigo 200 Transmitter with a Cable.....	18
Figure 15	Attaching the Probe to Indigo 200 Series.....	19
Figure 16	Enabling and Accessing Indigo's Wireless Configuration Interface.....	20
Figure 17	Indigo Login View.....	21
Figure 18	HMP4 Humidity Measurement Accuracy as a Function of Temperature (Including Non-Linearity and Repeatability).....	26
Figure 19	HMP4 Temperature Measurement Accuracy over Full Range (Including Non-Linearity and Repeatability).....	27
Figure 20	HMP5 Humidity Measurement Accuracy as a Function of Temperature (Including Non-Linearity and Repeatability).....	29
Figure 21	HMP5 Temperature Measurement Accuracy over Full Range (Including Non-Linearity and Repeatability).....	29
Figure 22	HMP7 Humidity Measurement Accuracy as Function of Temperature (Including Non-Linearity and Repeatability).....	32
Figure 23	HMP7 Temperature Measurement Accuracy over Full Range (Including Non-Linearity and Repeatability).....	32
Figure 24	HMP8 Humidity Measurement Accuracy as a Function of Temperature (Including Non-Linearity and Repeatability).....	34
Figure 25	HMP8 Temperature Measurement Accuracy over Full Range (Including Non-Linearity and Repeatability).....	35
Figure 26	TMP1 Temperature Measurement Accuracy over Full Range (Including Non-Linearity and Repeatability).....	37
Figure 27	Probe Body Dimensions.....	38
Figure 28	HMP4 Probe Head Dimensions.....	38
Figure 29	HMP5 Probe Head Dimensions.....	39
Figure 30	HMP7 Probe Head Dimensions.....	39
Figure 31	HMP8 Probe Head Dimensions.....	39
Figure 32	TMP1 Probe Head Dimensions.....	39
Figure 33	Optional Duct Kit 215003 Dimensions.....	40
Figure 34	Optional Ball Valve Installation Kit Dimensions.....	40

List of Tables

Table 1	Document Versions.....	5
Table 2	Related Manuals.....	5
Table 3	Suitability of Cleaning Agents.....	22
Table 4	Measurement Performance.....	26
Table 5	SI Traceable Calibration.....	27
Table 6	Operating Environment.....	27
Table 7	Inputs and Outputs.....	27
Table 8	Mechanical Specifications.....	28
Table 9	Measurement Performance.....	28
Table 10	SI Traceable Calibration.....	30
Table 11	Operating Environment.....	30
Table 12	Inputs and Outputs.....	30
Table 13	Mechanical Specifications.....	30
Table 14	Measurement Performance.....	31
Table 15	SI Traceable Calibration.....	32
Table 16	Operating Environment.....	33
Table 17	Inputs and Outputs.....	33
Table 18	Mechanical Specifications.....	33
Table 19	Measurement Performance.....	34
Table 20	SI Traceable Calibration.....	35
Table 21	Operating Environment.....	35
Table 22	Inputs and Outputs.....	35
Table 23	Mechanical Specifications.....	36
Table 24	Measurement Performance.....	36
Table 25	SI Traceable Calibration.....	37
Table 26	Operating Environment.....	37
Table 27	Inputs and Outputs.....	37
Table 28	Mechanical Specifications.....	38
Table 29	Accessories.....	40
Table 30	Accessories.....	41
Table 31	Accessories.....	42
Table 32	Accessories.....	43
Table 33	Accessories.....	44
Table 34	Default Modbus Serial Communication Settings.....	45
Table 35	Modbus Function Codes.....	45
Table 36	16-bit Signed Integer Format Details.....	46
Table 37	Modbus Measurement Data Registers (Read-Only).....	47
Table 38	Modbus Configuration Data Registers (Writable).....	49
Table 39	Device Identification Objects.....	51
Table 40	Modbus Test Registers (Read-Only).....	52

1. About This Document

1.1 Version Information

This document provides instructions for installing, using, and maintaining Vaisala HUMICAP® Humidity and Temperature Probes HMP4, HMP5, HMP7, HMP8, and Temperature Probe TMP1.

Table 1 Document Versions

Document Code	Date	Description
M212022EN-B	June 2018	This document. Applicable from software version 1.0.6 onward. Updated instructions for connecting to Indigo transmitters. Updated sections Measurement Data Registers (page 47) and Configuration Registers (page 49) .
M212022EN-A	November 2017	First version.

1.2 Related Manuals

Table 2 Related Manuals

Document Code	Name
M211982EN	HMP4, HMP5, HMP7, HMP8, and TMP1 Quick Guide

1.3 Documentation Conventions



WARNING! Warning alerts you to a serious hazard. If you do not read and follow instructions carefully at this point, there is a risk of injury or even death.



CAUTION! Caution warns you of a potential hazard. If you do not read and follow instructions carefully at this point, the product could be damaged or important data could be lost.



Note highlights important information on using the product.



Tip gives information for using the product more efficiently.



Lists tools needed to perform the task.



Indicates that you need to take some notes during the task.

1.4 Trademarks

Vaisala® and HUMICAP® are registered trademarks of Vaisala Oyj.

All other product or company names that may be mentioned in this publication are trade names, trademarks, or registered trademarks of their respective owners.

2. Product Overview

HMP4, HMP5, HMP7, and HMP8 are humidity and temperature measurement probes with a digital (Modbus) output. TMP1 is a temperature-only version. The probes are designed for demanding humidity and temperature measurement applications. Each probe model has a different probe head, but the same probe body and a 2 m (6.5 ft) cable between the probe body and the probe head.

The probes are compatible with Vaisala Indigo transmitters. They can also be connected to Vaisala Insight software for configuration, diagnostics, and temporary online monitoring.

2.1 Probe Structure

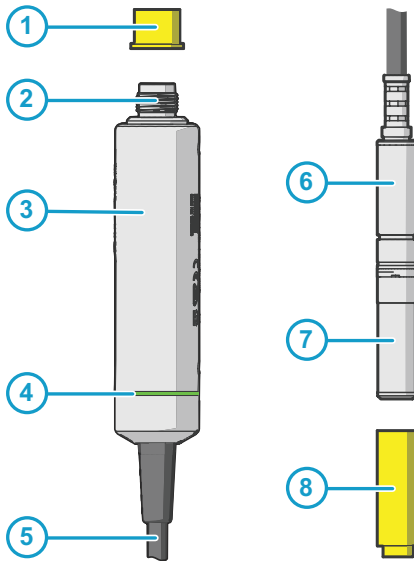

Figure 1 Probe Parts

- 1 Protection cap (remove before use)
- 2 5-pin M12 connector
- 3 Probe body with type label
- 4 Status indicator:
 - Green Power on and probe online, flashes when communicating
 - Red Error
 - Off Power off or indicator disabled
- 5 Probe cable. Do not cut.
- 6 Probe head (HMP7 model shown)
- 7 Sensor(s) under protective filter
- 8 Protection cap (remove before use)

2.2 Basic Features and Options

- Comprehensive list ¹⁾ of output parameters:

Relative humidity, temperature, delta-T, dew point temperature, dew point temperature difference, frost point temperature, wet-bulb temperature, absolute humidity, mixing ratio, vapor pressure, saturation vapor pressure, enthalpy

- Temperature measurement range -70 ... +180 °C (-94 ... +356 °F)

1) Humidity measurement parameters available on HMP models only

- Sensor purge provides superior chemical resistance (HMP models only)
- Probe and sensor warming functions minimize condensation on probe (HMP models only)
- Traceable calibration certificate:
 - HMP models: 5 points for humidity, 1 point for temperature
 - TMP1: 2 points for temperature
- Standalone Modbus RTU over RS-485
- Plug & play compatible with Indigo series of transmitters
- Can be connected to Vaisala Insight software for configuration, diagnostics, and temporary online monitoring

2.3 Additional Features with Indigo Transmitters

The probes are compatible with Vaisala Indigo 200 transmitters starting from Indigo transmitter serial number N4650357 (Indigo 200 transmitter software version 1.3.2 or higher). Connecting the probe to an Indigo transmitter provides a range of additional options for outputs, measurement viewing, status monitoring, and configuration interface access.

Examples of additional features available with Indigo transmitters include:

- 3.5" TFT LCD color display or non-display model with LED indicator
- Digital output or 3 analog outputs (depending on the transmitter model)
- 2 configurable relays
- Wireless browser-based configuration interface for mobile devices and computers (IEEE 802.11 b/g/n WLAN)

The selection of available additional features (for example, output and connectivity options) varies depending on the Indigo transmitter model. For more information on Indigo transmitters, see www.vaisala.com/indigo.

2.4 Safety



WARNING! When returning a product for calibration or repair, make sure it has not been exposed to dangerous contamination, and is safe to handle without special precautions.



CAUTION! Do not attempt to open the probe body. There are no user serviceable parts inside the probe body.



Information on spare parts, accessories, and calibration products is available online at www.vaisala.com and store.vaisala.com.

2.5 ESD Protection

Electrostatic Discharge (ESD) can cause immediate or latent damage to electronic circuits. Vaisala products are adequately protected against ESD for their intended use. However, it is possible to damage the product by delivering an electrostatic discharge when touching, removing or inserting any objects inside the equipment housing.

Avoid touching component contacts or connectors when working with the device.

2.6 HMP4 Probe

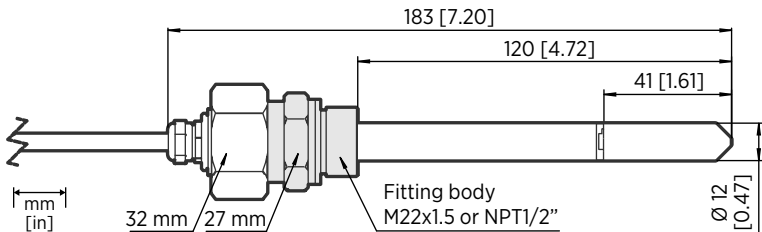

Figure 2 HMP4 Probe Head Dimensions

Vaisala HUMICAP® Humidity and Temperature Probe HMP4 is designed for high-pressure applications such as compressed air systems in maritime, breathing air, and industrial applications, where measurement performance and chemical tolerance are essential.

- Operating pressure 0 ... 10 MPa (0 ... 100 bar)
- M22x1.5 and NPT1/2" probe fittings included
- Sintered AISI316L filter standard in delivery

2.7 HMP5 Probe

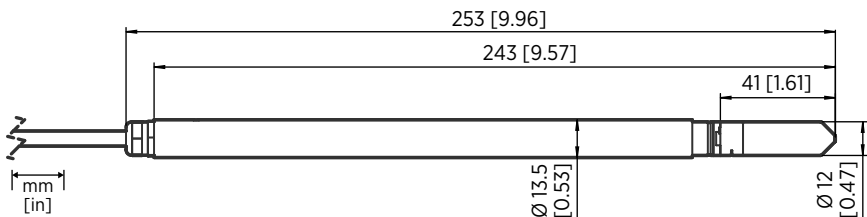

Figure 3 HMP5 Probe Head Dimensions

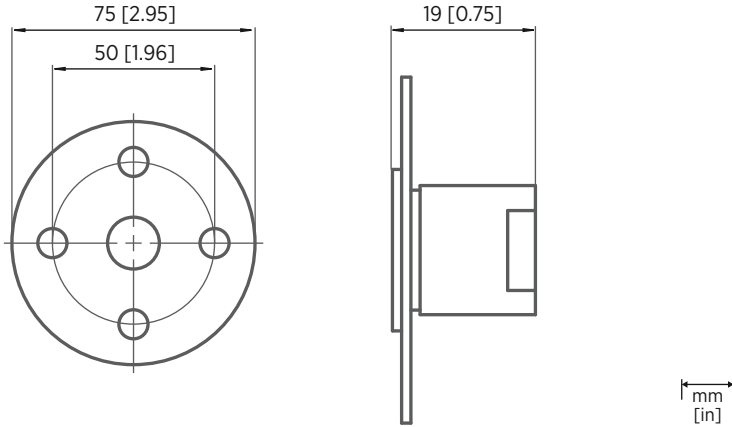

Figure 4 Optional Mounting Flange 210696 Dimensions

Vaisala HUMICAP® Humidity and Temperature Probe HMP5 is designed for high-temperature applications such as baking ovens, pasta dryers, and industrial drying kilns, where measurement performance and chemical tolerance are essential.

- Temperature measurement range -70 ... +180 °C (-94 ... +356 °F)
- 250-mm (9.84-in) probe allows easy process installation through insulation
- Sintered AISI316L filter standard in delivery

2.8 HMP7 Probe

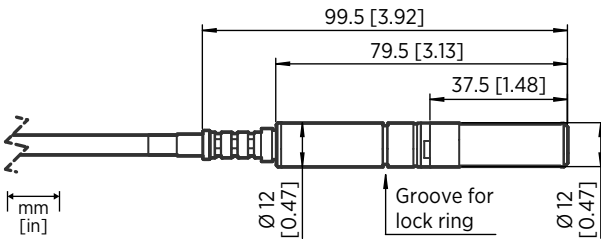

Figure 5 HMP7 Probe Head Dimensions

Vaisala HUMICAP® Humidity and Temperature Probe HMP7 is designed for applications that involve constant high humidity or rapid changes in humidity, such as drying and test chambers, combustion air, and other humidifiers and meteorological measurements, where measurement performance and chemical tolerance are essential.

- Probe and sensor warming functions minimize condensation on probe
- Vapor and pressure proof construction

- Stainless steel mesh filter standard in delivery

Probe Heating

HMP7 supports probe heating. Probe heating heats up not only the sensor, but the entire probe head. When probe temperature is heated above dew point temperature, condensation on the probe can be avoided while measuring the dew point temperature of the process.

Probe heating is disabled by default. If you enable probe heating, output parameters that are dependent on temperature measurement (such as relative humidity) are disabled, unless the true temperature of the measured environment is updated to the temperature compensation register of the probe from another measurement instrument (for example, the TMP1 probe). Output parameters such as dew point temperature that can be measured or calculated without this external temperature information are available even without the temperature input.

2.9 HMP8 Probe

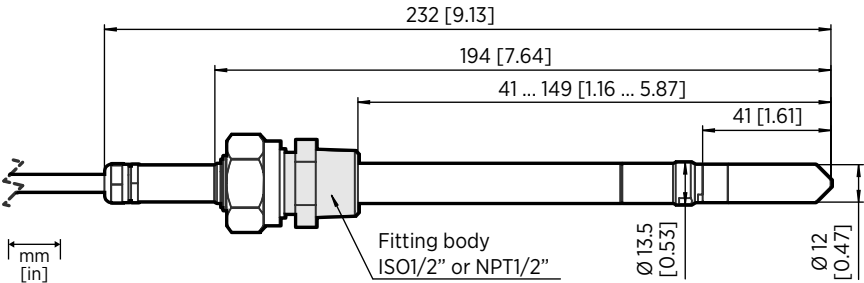

Figure 6 HMP8 Probe Head Dimensions

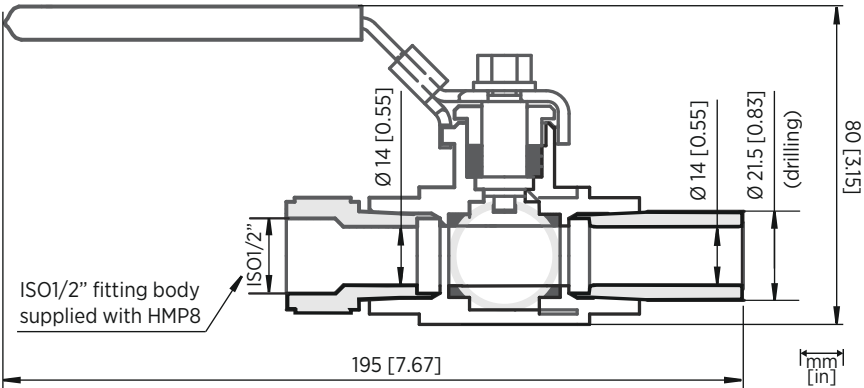

Figure 7 Optional Ball Valve Installation Kit Dimensions

Vaisala HUMICAP® Humidity and Temperature Probe HMP8 is designed for pressurized applications in compressed air systems, refrigerant dryers, and other pressurized industrial applications, where easy insertion and removal of the probe and adjustable installation depth into the pipeline are needed.

- Probe installation depth can be freely adjusted and probe can be hot-swapped from pressurized pipelines with an installation valve
- Operating pressure 0 ... 4 MPa (0 ... 40 bar)
- ISO1/2" and NPT1/2" probe fittings and press handle included
- Sintered AISI316L filter standard in delivery

2.10 TMP1 Probe

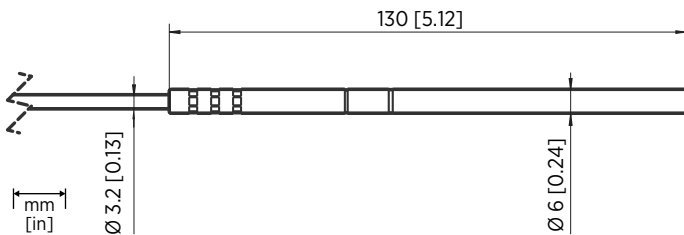

Figure 8 TMP1 Probe Head Dimensions

Vaisala Temperature Probe TMP1 is designed for demanding temperature measurements in industrial applications such as pharmaceutical industry and calibration laboratories, where accuracy and robustness are essential.

- Temperature measurement range -70 ... +180 °C (-94 ... +356 °F)
- Temperature accuracy up to 0.1 °C (0.18 °F)

3. Installation

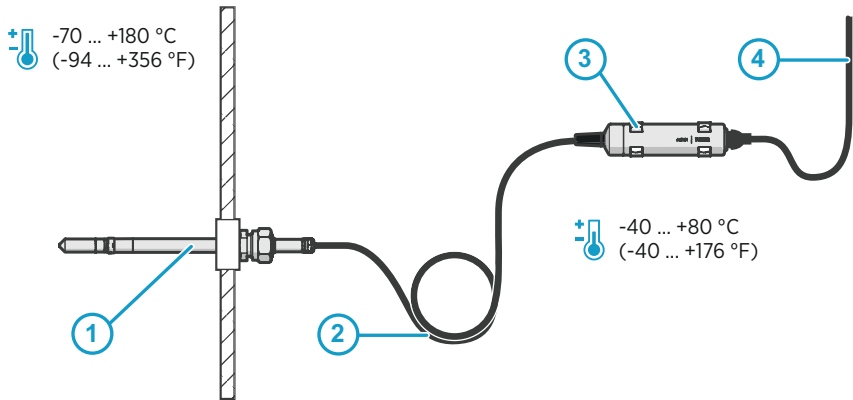

Figure 9 Example Installation of HMP8 Model

- 1 Mount the probe head horizontally to prevent any water condensing on the probe head from running to the sensors.
- 2 Let the cable hang loosely to prevent condensed water from running along the cable to the probe head.
- 3 Attach the probe body to a wall or other surface using the two mounting clips (Vaisala item 243257SP) supplied with the probe. Each clip attaches to the installation surface with one screw (screw hole \varnothing 4.2 mm).
- 4 Cable to Modbus master or Indigo transmitter.



If the temperature of the measured environment differs greatly from ambient temperature, the whole probe and preferably plenty of cable must be inside the process. This prevents measurement inaccuracy caused by heat conduction along the cable.

More Information

- [Default Communication Settings \(page 45\)](#)

3.1 Probe Body Dimensions and Pinout

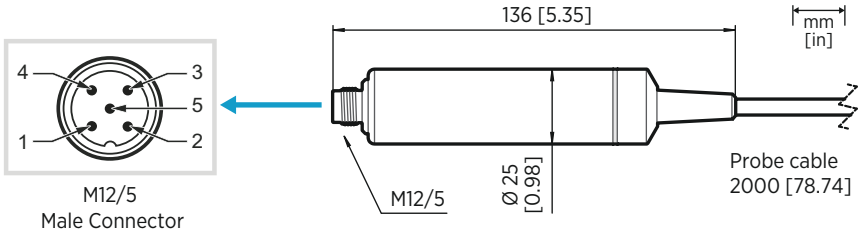

Figure 10 Probe Body

Pin #	Function	Notes	Wire Colors in Vaisala Cables
1	Power supply	Supply voltage: <ul style="list-style-type: none"> • HMP7: 18 ... 30 VDC • Other models: 15 ... 30 VDC Typical current 10 mA, max. 500 mA.	Brown
2	RS-485-		White
3	Power GND		Blue
4	RS-485+		Black
5	Not connected		Gray



Recommended maximum length of the RS-485 line is 30 m (98 ft).

4. Configuration with Insight Software

4.1 Vaisala Insight Software

Vaisala Insight software is a configuration software for Indigo-compatible devices. The supported operating systems are Windows 7 (64-bit), Windows 8.1 (64-bit), and Windows 10 (64-bit).

With the Insight software, you can:

- See probe information and status
- See real-time measurement
- Calibrate and adjust the probe
- Configure probe features such as measurement filtering, chemical purge, heating, and serial communication

Download Vaisala Insight software at www.vaisala.com/insight.

The probe can be connected to Vaisala Insight software using a Vaisala USB cable (no. 242659).

4.2 Connecting to Insight Software



- Computer with Vaisala Insight software installed
- USB connection cable (no. 242659)

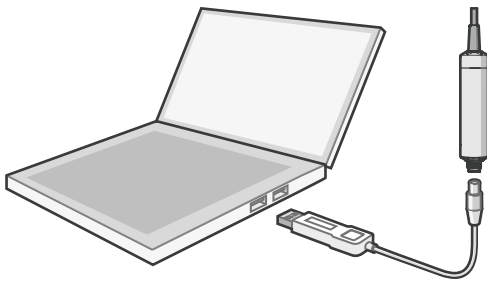



Figure 11 Connecting Probe to Insight

- ▶ 1. Open the Insight software.
2. Connect the USB cable to a free USB port on the PC.
3. Connect the probe to the USB cable.
4. Wait for Insight software to detect the probe.

4.3 Configuration Options

Select  > **Configure Device** to access configuration options in Insight software.

The available configuration options correspond to the Modbus configuration registers; see [Configuration Registers \(page 49\)](#). Insight software is the recommended way to change the probe configuration.



You can restore the probe back to its default settings using the **Factory Default Settings > Restore Settings** function. Doing this will also clear any user adjustment and restore the latest factory calibration.

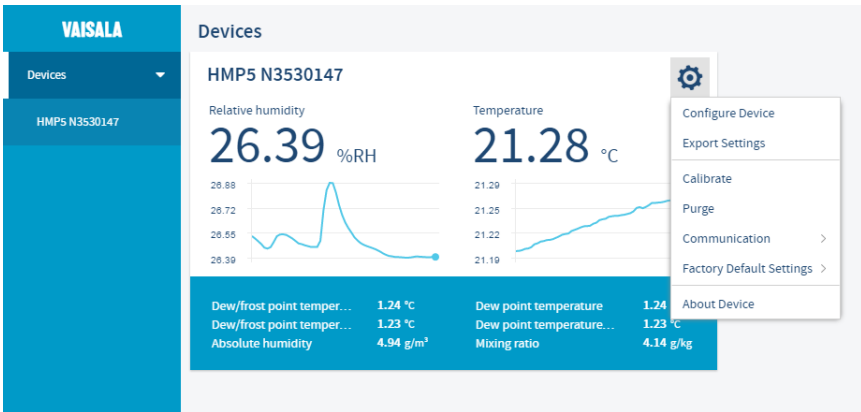

Figure 12 HMP5 in Insight Software

5. Using Probe with Indigo Transmitters

5.1 Indigo Overview

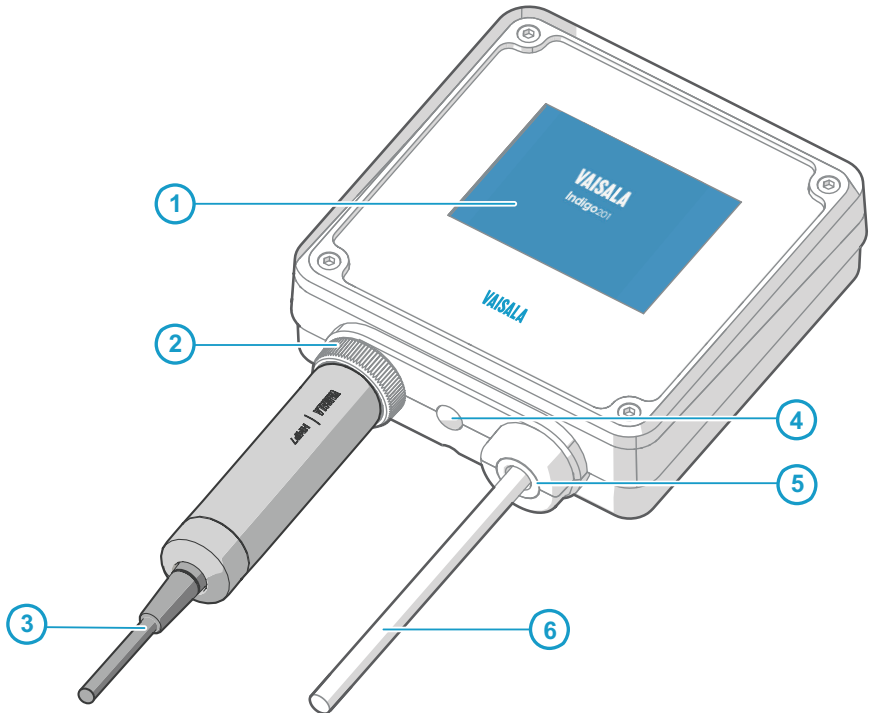

Figure 13 HMP7 Attached to Indigo 200 Transmitter

- 1 3.5" TFT LCD color display; non-display option with LED available for certain models
- 2 Locking wheel: insert probe, hold in place, and turn the wheel counterclockwise
- 3 Cable to probe head
- 4 Wireless configuration interface (WLAN) activation button
- 5 Rubber lead-through with strain relief. Cable feedthrough option also at back of transmitter.
- 6 Input/output cable

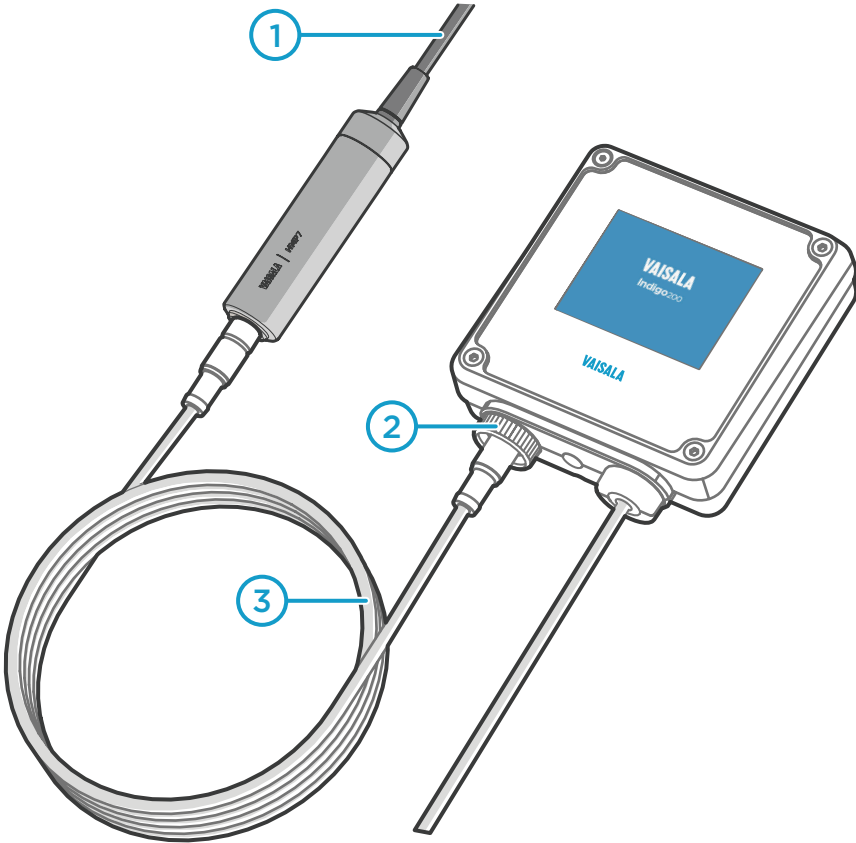

Figure 14 HMP7 Attached to Indigo 200 Transmitter with a Cable

- 1 Cable to probe head
- 2 Locking wheel: insert cable, hold in place, and turn the wheel counterclockwise
- 3 Connection cable

The probe can be connected to Vaisala Indigo transmitters, either directly on the transmitter from the probe's connector, or by using a cable between Indigo and the probe.

Indigo transmitters are host devices that extend the feature set of connected probes with a range of additional options for outputs, configuration access, measurement viewing, and status monitoring.

The selection of available additional features (for example, output and connectivity options) varies depending on the Indigo transmitter model. Depending on the model, a display is available as an optional selection or as a standard feature. In the non-display model, an LED indicator is used for notifications.

5.2 Attaching Probes to Indigo Transmitters

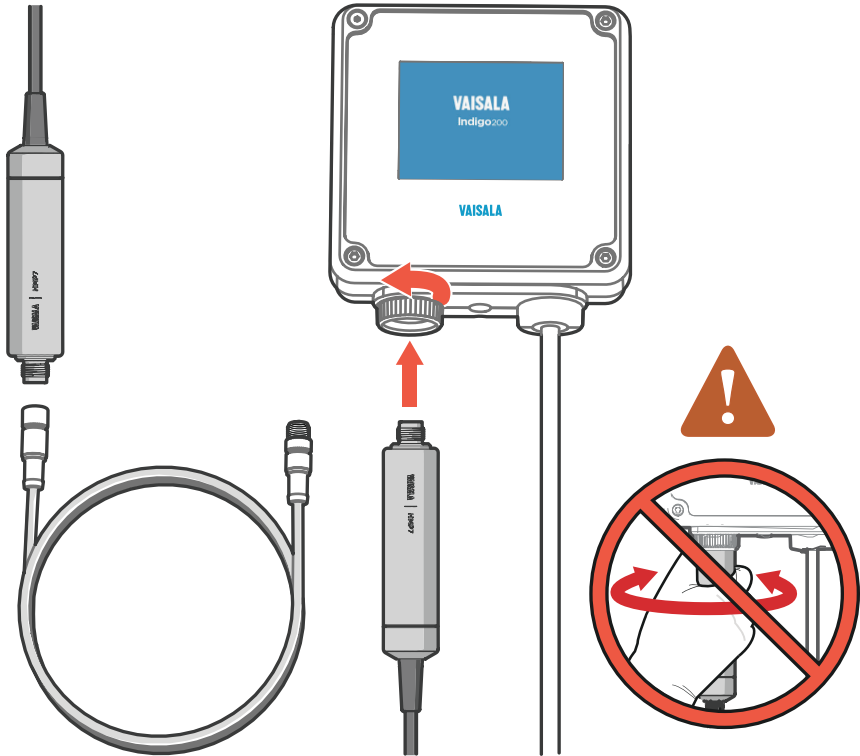

Figure 15 Attaching the Probe to Indigo 200 Series

- ▶ 1. Insert the probe or the connection cable into the transmitter's connector. Use of connection cable is recommended for strain relief.
2. Turn the locking wheel of the transmitter to lock the probe or cable in place.
Do not turn the probe or the cable itself, as that will damage the connectors.
3. If you are using a connection cable, connect the probe to the cable.
4. When the transmitter recognizes the connected probe, it shows a notification message on the display.

5.3 Wireless Configuration Interface Overview

The wireless configuration interface has two user levels:

- All users have view-only access (no configuration rights, not password protected).
- Personnel that carry out configuration tasks can log in with an administrative password that allows changing the transmitter and probe settings.

To use the wireless configuration interface to modify the settings of your Indigo transmitter and the connected probe, you must first enable the transmitter's wireless connection and then connect to Indigo with your mobile device or computer. Most major browsers (for example, Firefox, Chrome, Safari, and Internet Explorer) are supported: using the most recent version is recommended.

5.4 Connecting to Wireless Configuration Interface

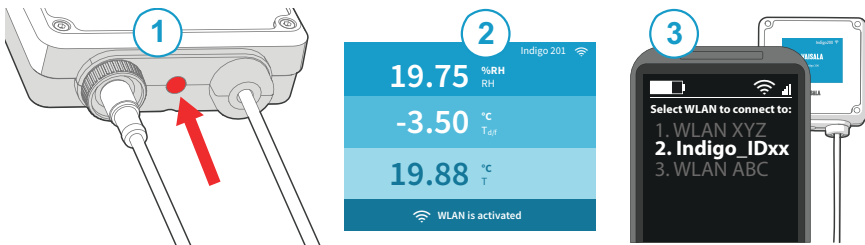

Figure 16 Enabling and Accessing Indigo's Wireless Configuration Interface

- 1 Wireless connection activation button
- 2 Wireless connection indicator (WLAN symbol) on the Indigo display
- 3 Choose Indigo (**Indigo_ID[xx]**) from your wireless device's list of available connections

5.5 Logging in to Wireless Configuration Interface

The screenshot shows a login form with the following elements:

- Title: **Log in to Configuration Interface**
- User name: A dropdown menu showing 'Admin'.
- Password: A text field with five dots representing a masked password.
- Log in: A large blue button.
- Serial No. A1234567
- Version 1.2.0

Figure 17 Indigo Login View

When you open Indigo's wireless configuration interface in your browser, you are prompted to log in. There are 2 available user levels:

- **User:** view-only access available for all users. Does not require a password.
- **Admin:** password-protected access. To change settings, you must log in as admin.

To log in:

- ▶ 1. Enter the user name and password:
 - a. To log in as user (view-only access, no configuration rights), select **User** from the **User name** dropdown. Leave the **Password** field empty.
 - b. To log in as admin (required for configuration), select **Admin** in the **User name** dropdown and type the admin password (default: **12345**) in the **Password** field.
2. Select **Log in** after entering the login credentials. The wireless configuration interface opens in the **Measurements** view.



The user level (**User** or **Admin**) is shown in the upper right corner of all menu views. Select the user/admin icon in the upper right corner to change the user level.

6. Maintenance

6.1 Cleaning the Probe



CAUTION! Do not attempt to clean the sensors under the filter in any way.



Do not spray anything directly on the probe head, since that may deposit impurities on the sensors.

You can clean the probe, probe body, and cable by wiping them with a soft, lint-free cloth moistened with water or a suitable cleaning agent, such as isopropyl alcohol. Do not wipe the filter: wiping the filter may block its pores and/or deposit residue on the filter. If the filter is heavily contaminated, replace it.

When cleaning, follow these precautions:

- Avoid touching the filter. If you need to touch the filter, always wear clean gloves (cotton, rubber or similar material). Keep the filter free of any grease or oil.
- Do not scrape the probe or the probe body.
- Do not immerse the probe or the probe body in liquid to clean them.
- Wipe cleaning agents off the probe, probe body, and the cable after cleaning.

After cleaning the probe, it is recommended to perform a chemical purge.

6.1.1 Chemical Tolerance



Avoid exposing the probe to cleaning agents for unnecessarily long periods of time.

Table 3 Suitability of Cleaning Agents

Cleaning Agent	Suitability
Acetone	Suitable
Chlorine disinfectants	Suitable
Ethanol	Suitable
Heptane	Suitable
Isopropyl alcohol	Suitable

6.2 Changing the Probe Filter



- New compatible filter
- Clean lint-free gloves



CAUTION! Without the filter in place, the sensor is easily damaged – handle the probe head carefully.

- ▶ 1. Put on clean gloves before touching the filter.
2. Turn the filter counter-clockwise to loosen it.
3. Remove the filter from the probe head. Be careful not to touch the sensors with the filter.
4. Install a new filter on the probe head. Tighten the filter properly (recommended force 5 Nm).

6.3 Calibration and Adjustment

The probe is fully calibrated and adjusted as shipped from the factory. To maintain the accuracy of the measurement, calibrate and adjust the probe as needed. Typical calibration interval is one year, but depending on the application it may be necessary to check the accuracy more frequently.

When adjustment is necessary, you can have Vaisala calibrate and adjust the probe. To order calibration services from Vaisala, visit store.vaisala.com. You can also do the adjustment yourself using the Insight software.



WARNING! When returning a product for calibration or repair, make sure it has not been exposed to dangerous contamination, and is safe to handle without special precautions.



If you think the device is not measuring correctly, calibration and adjustment is not the first thing to do. Check the following first:

- Make sure nothing is interfering with the measurement: heat sources, temperature differences, or condensation.
- Check that there is no moisture on the probe. If the sensor has become wet, wait for it to dry.
- Always wait for the measurement to stabilize.



Calibration means comparing the measurement output of the device to a known reference, such as a known environment in a calibration chamber or the output of a reference instrument. Correcting the reading of the device so that it measures accurately is referred to as **adjustment**.

6.3.1 Adjustment Points and Requirements

You can adjust the humidity measurement in 1 ... 5 points, and temperature measurement in 1 ... 2 points. Note the following:

- To enable humidity adjustment in more than two points, you must set the Insight software into **Advanced Mode**.
- If you are adjusting in more than one humidity point, make sure the first two points are at least 10 %RH apart.
- The probe will reject adjustments that are too large, that is, greater than 10 %RH for humidity and 0.5 °C for temperature. If the probe appears to need such a large correction, perform a sensor purge using the Insight software and repeat the adjustment procedure. Make sure the measurement has stabilized and the reference environment is reliable. If the required adjustment is still too large, the probe needs to be serviced by Vaisala.



When adjustment of humidity measurement is necessary, Vaisala recommends adjusting in two points, 11 %RH and 75 %RH. These humidities can be produced using the Vaisala HMK15 Humidity Calibrator. Adjustment of temperature measurement is typically not necessary.



6.3.2 Adjusting Measurement using Insight Software



- Computer with Windows operating system and Vaisala Insight software installed
- Vaisala USB cable 242659 for connecting the probe
- Reference environment(s) for producing the desired humidity and/or temperature

This procedure can be used to adjust the probe's humidity or temperature measurement. If you want to adjust both, repeat the procedure.

Because stabilization of temperature and humidity takes time, you should expect the adjustment procedure to take at least 30 minutes for each adjustment point.

- ▶ 1. Connect the probe to Insight. See [Connecting to Insight Software \(page 15\)](#).
2. If you intend to adjust humidity measurement, first select  > **Purge** to perform a chemical purge to condition the sensor. Wait a few minutes for purge to complete.
3. Select  > **Calibrate** > **Yes** to switch the probe to calibration mode.
In calibration mode, the device will not use functions that may interfere with calibration and adjustment.

4. Select the type of adjustment to perform: **RH adjustment** or **T adjustment**.
5. Define the needed adjustment for the first measurement point:
 - a. Insert the probe head in the reference environment for the first calibration point.
 - b. Wait for the measurement to stabilize fully.
 - c. Click the **Reference value, point 1** text box and enter the reference value of the calibration point. Press **ENTER** or click outside the text box when done.
 - d. The probe automatically enters the measured values for the calibration point.
6. If you want to adjust in more than one point, repeat [step 5](#) for all desired calibration points.



You can adjust humidity measurement in up to five points when Insight is set to **Advanced mode**.

7. Select **Activate adjustment > Yes** to store the adjustment in the probe.
8. Check the message that appears at the top of the screen. If the message indicates that the adjustment is activated successfully, your adjustment is stored in the probe.
9. Select the **Calibration information** tab and update the **Calibration date** and **Calibration text**.
10. Select **Close > Yes** to exit the calibration mode.

7. Technical Data

7.1 HMP4 Specifications

Table 4 Measurement Performance

Property	Description/Value
Relative Humidity	
Sensor	HUMICAP R2 Composite
Measurement range	0 ... 100 %RH
Accuracy at +23 °C (+73.4 °F) ¹⁾	±0.8 %RH (0 ... 90 %RH)
T ₆₃ response time	15 s
Temperature	
Sensor	Pt100 RTD Class F0.1 IEC 60751
Measurement range	-70 ... +180 °C (-94 ... +356 °F)
Accuracy at +23 °C (+73.4 °F) ^{1) 2)}	±0.1 °C (±0.18 °F)

- 1) Defined against calibration reference
- 2) Exposing temperature sensor to temperatures outside -20 ... +150 °C (-4 ... +302 °F) may cause permanent additional deviation of ±0.1 °C (0.18 °F)

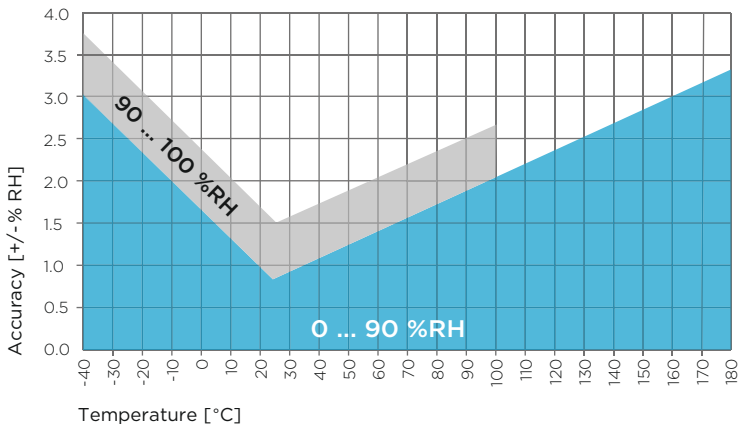

Figure 18 HMP4 Humidity Measurement Accuracy as a Function of Temperature (Including Non-Linearity and Repeatability)

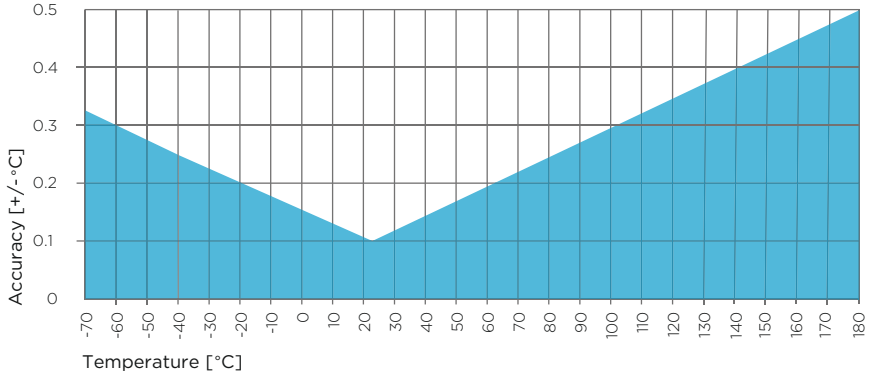

Figure 19 HMP4 Temperature Measurement Accuracy over Full Range (Including Non-Linearity and Repeatability)

Table 5 SI Traceable Calibration

Property	Description/Value
Uncertainty of relative humidity calibration ($k = 2$)	±0.5 %RH (0 ... 40 %RH) ±0.8 %RH (40 ... 95 %RH)
Uncertainty of temperature calibration ($k = 2$)	±0.1 °C (±0.18 °F) at +23 °C (+73.4 °F)

Table 6 Operating Environment

Property	Description/Value
Operating temperature range for probe body	-40 ... +80 °C (-40 ... +176 °F)
Operating temperature range for probe head	-70 ... +180 °C (-94 ... +356 °F)
Operating environment	Suitable for outdoor use
IP rating	IP66
Electromagnetic compatibility	Complies with EMC standard EN61326-1, Electrical equipment for measurement, control and laboratory use - EMC requirements - Industrial environment
Operational pressure	< 100 bar

Table 7 Inputs and Outputs

Property	Description/Value
Operating voltage	15 ... 30 VDC

Property	Description/Value
Current consumption	10 mA typical 500 mA max.
Digital output	RS-485, non-isolated
Default serial settings	19200 bps N 8 2
Protocols	Modbus RTU
Output Parameters	
Relative humidity, temperature, dew point temperature, wet-bulb temperature, absolute humidity, mixing ratio, water concentration, water mass fraction, water vapor pressure, enthalpy	

Table 8 Mechanical Specifications

Property	Description/Value
Probe fitting	M22x1.5 and NPT1/2" fittings included
Connector	M12/5
Weight	530 g (18.7 oz)
Materials	
Probe	AISI316
Probe body	AISI316
Cable jacket	FEP

7.2 HMP5 Specifications

Table 9 Measurement Performance

Property	Description/Value
Relative Humidity	
Sensor	HUMICAP R2 Composite
Measurement range	0 ... 100 %RH
Accuracy at +23 °C (+73.4 °F) ¹⁾	±0.8 %RH (0 ... 90 %RH)
T ₆₃ response time	15 s
Temperature	
Sensor	Pt100 RTD Class F0.1 IEC 60751
Measurement range	-70 ... +180 °C (-94 ... +356 °F)

Property	Description/Value
Accuracy at +23 °C (+73.4 °F) ^{1) 2)}	±0.1 °C (±0.18 °F)

- 1) Defined against calibration reference
- 2) Exposing temperature sensor to temperatures outside -20 ... +150 °C (-4 ... +302 °F) may cause permanent additional deviation of ±0.1 °C (0.18 °F)

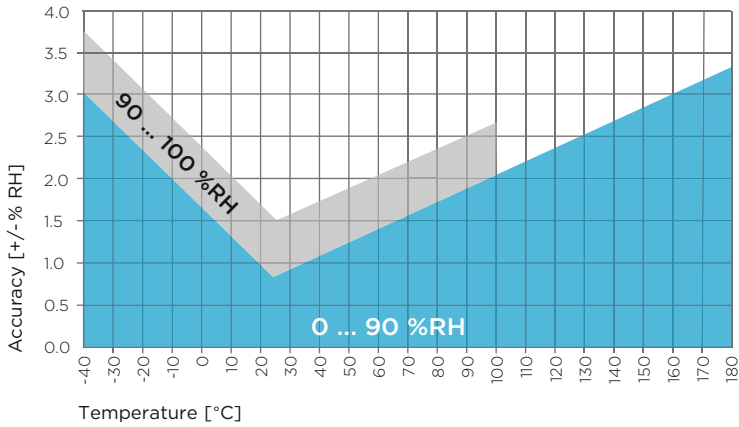

Figure 20 HMP5 Humidity Measurement Accuracy as a Function of Temperature (Including Non-Linearity and Repeatability)

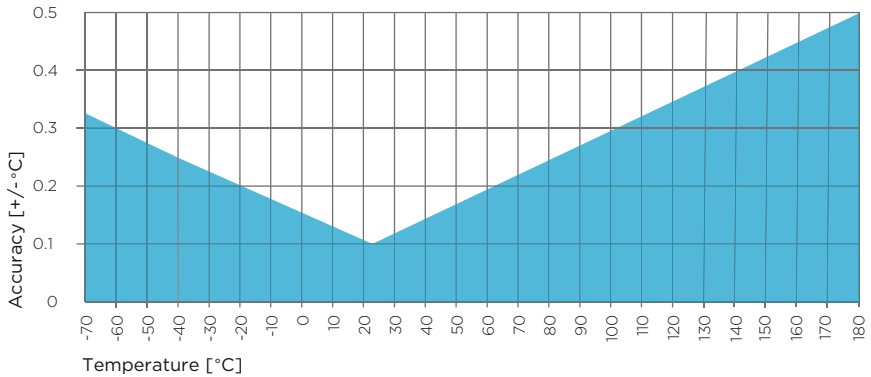

Figure 21 HMP5 Temperature Measurement Accuracy over Full Range (Including Non-Linearity and Repeatability)

Table 10 SI Traceable Calibration

Property	Description/Value
Uncertainty of relative humidity calibration ($k = 2$)	$\pm 0.5\%RH$ (0 ... 40 %RH) $\pm 0.8\%RH$ (40 ... 95 %RH)
Uncertainty of temperature calibration ($k = 2$)	$\pm 0.1\text{ }^\circ\text{C}$ ($\pm 0.18\text{ }^\circ\text{F}$) at $+23\text{ }^\circ\text{C}$ ($+73.4\text{ }^\circ\text{F}$)

Table 11 Operating Environment

Property	Description/Value
Operating temperature range for probe body	$-40 \dots +80\text{ }^\circ\text{C}$ ($-40 \dots +176\text{ }^\circ\text{F}$)
Operating temperature range for probe head	$-70 \dots +180\text{ }^\circ\text{C}$ ($-94 \dots +356\text{ }^\circ\text{F}$)
Operating environment	Suitable for outdoor use
IP rating	IP66
Electromagnetic compatibility	Complies with EMC standard EN61326-1, Electrical equipment for measurement, control and laboratory use - EMC requirements - Industrial environment

Table 12 Inputs and Outputs

Property	Description/Value
Operating voltage	15 ... 30 VDC
Current consumption	10 mA typical 500 mA max.
Digital output	RS-485, non-isolated
Default serial settings	19200 bps N 8 2
Protocols	Modbus RTU
Output Parameters	
Relative humidity, temperature, dew point temperature, wet-bulb temperature, absolute humidity, mixing ratio, water concentration, water mass fraction, water vapor pressure, enthalpy	

Table 13 Mechanical Specifications

Property	Description/Value
Connector	M12/5
Weight	436 g (15.37 oz)
Materials	

Property	Description/Value
Probe	AISI316L
Probe body	AISI316L
Cable jacket	FEP

7.3 HMP7 Specifications

Table 14 Measurement Performance

Property	Description/Value
Relative Humidity	
Sensor	HUMICAP R2 Composite
Measurement range	0 ... 100 %RH
Accuracy at +23 °C (+73.4 °F) ¹⁾	±0.8 %RH (0 ... 90 %RH)
T ₆₃ response time	15 s
Temperature	
Sensor	Pt100 RTD Class F0.1 IEC 60751
Measurement range	-70 ... +180 °C (-94 ... +356 °F)
Accuracy at +23 °C (+73.4 °F) ^{1) 2)}	±0.1 °C (±0.18 °F)

1) *Defined against calibration reference*

2) *Exposing temperature sensor to temperatures outside -20 ... +150 °C (-4 ... +302 °F) may cause permanent additional deviation of ±0.1 °C (0.18 °F)*

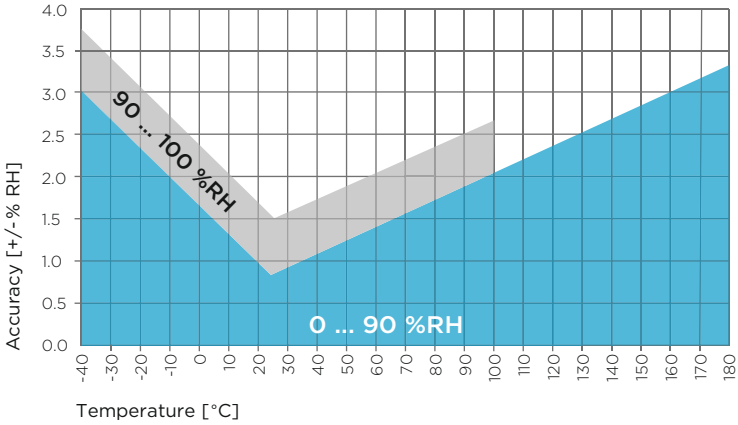

Figure 22 HMP7 Humidity Measurement Accuracy as Function of Temperature (Including Non-Linearity and Repeatability).

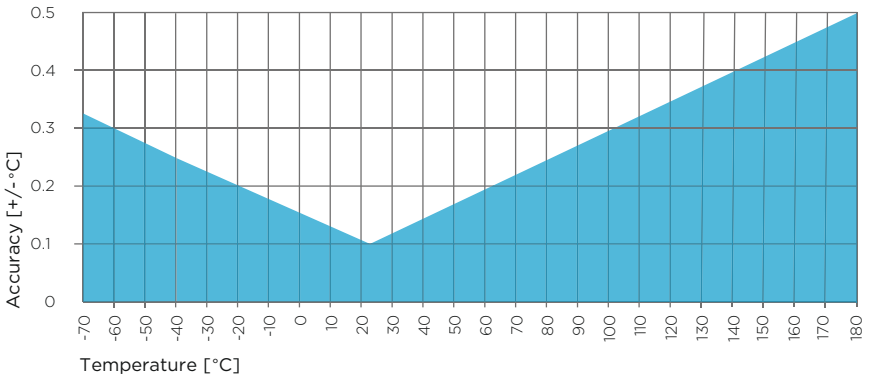

Figure 23 HMP7 Temperature Measurement Accuracy over Full Range (Including Non-Linearity and Repeatability)

Table 15 SI Traceable Calibration

Property	Description/Value
Uncertainty of relative humidity calibration ($k = 2$)	±0.5 %RH (0 ... 40 %RH) ±0.8 %RH (40 ... 95 %RH)
Uncertainty of temperature calibration ($k = 2$)	±0.1 °C (±0.18 °F) at +23 °C (+73.4 °F)

Table 16 Operating Environment

Property	Description/Value
Operating temperature range for probe body	-40 ... +80 °C (-40 ... +176 °F)
Operating temperature range for probe head	-70 ... +180 °C (-94 ... +356 °F)
Operating environment	Suitable for outdoor use
IP rating	IP66
Electromagnetic compatibility	EN61326-1, Electrical equipment for measurement, control and laboratory use - EMC requirements - Industrial environment

Table 17 Inputs and Outputs

Property	Description/Value
Operating voltage	18 ... 30 VDC
Current consumption	10 mA typical 500 mA max.
Digital output	RS-485, non-isolated
Default serial settings	19200 bps N 8 2
Protocols	Modbus RTU
Output Parameters	
Relative humidity, temperature, dew point temperature, wet-bulb temperature, absolute humidity, mixing ratio, water concentration, water mass fraction, water vapor pressure, enthalpy	

Table 18 Mechanical Specifications

Property	Description/Value
Connector	M12/5
Weight	310 g (10.9 oz)
Materials	
Probe	AISI316L
Probe body	AISI316L
Cable jacket	FEP

7.4 HMP8 Specifications

Table 19 Measurement Performance

Property	Description/Value
Relative Humidity	
Sensor	HUMICAP R2 Composite
Measurement range	0 ... 100 %RH
Accuracy at +23 °C (+73.4 °F) ¹⁾	±0.8 %RH (0 ... 90 %RH)
T ₆₃ response time	15 s
Temperature	
Sensor	Pt100 RTD Class F0.1 IEC 60751
Measurement range	-70 ... +180 °C (-94 ... +356 °F)
Accuracy at +23 °C (+73.4 °F) ^{1) 2)}	±0.1 °C (±0.18 °F)

- 1) Defined against calibration reference
- 2) Exposing temperature sensor to temperatures outside -20 ... +150 °C (-4 ... +302 °F) may cause permanent additional deviation of ±0.1 °C (0.18 °F)

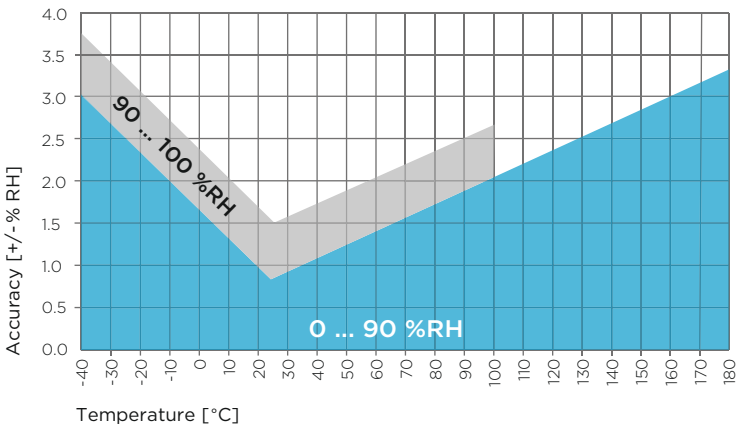

Figure 24 HMP8 Humidity Measurement Accuracy as a Function of Temperature (Including Non-Linearity and Repeatability)

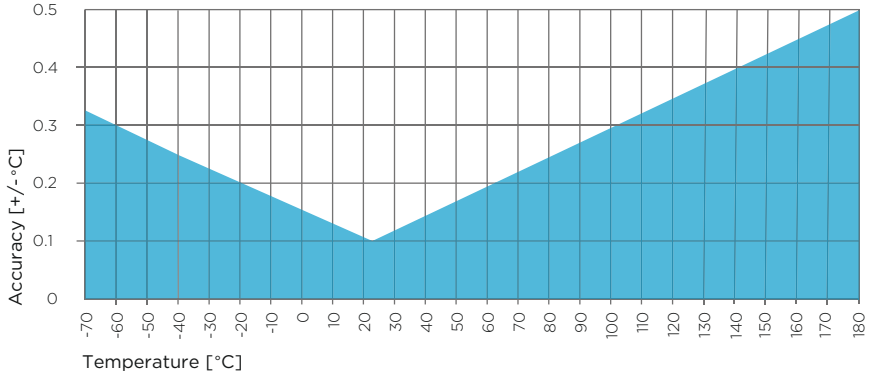

Figure 25 HMP8 Temperature Measurement Accuracy over Full Range (Including Non-Linearity and Repeatability)

Table 20 SI Traceable Calibration

Property	Description/Value
Uncertainty of relative humidity calibration ($k = 2$)	±0.5 %RH (0 ... 40 %RH) ±0.8 %RH (40 ... 95 %RH)
Uncertainty of temperature calibration ($k = 2$)	±0.1 °C (±0.18 °F) at +23 °C (+73.4 °F)

Table 21 Operating Environment

Property	Description/Value
Operating temperature range for probe body	-40 ... +80 °C (-40 ... +176 °F)
Operating temperature range for probe head	-70 ... +180 °C (-94 ... +356 °F)
Operating environment	Suitable for outdoor use
IP rating	IP66
Electromagnetic compatibility	Complies with EMC standard EN61326-1, Electrical equipment for measurement, control and laboratory use - EMC requirements - Industrial environment
Operational pressure	< 40 bar

Table 22 Inputs and Outputs

Property	Description/Value
Operating voltage	15 ... 30 VDC

Property	Description/Value
Current consumption	10 mA typical 500 mA max.
Digital output	RS-485, non-isolated
Default serial settings	19200 bps N 8 2
Protocols	Modbus RTU
Output Parameters	
Relative humidity, temperature, dew point temperature, wet-bulb temperature, absolute humidity, mixing ratio, water concentration, water mass fraction, water vapor pressure, enthalpy	

Table 23 Mechanical Specifications

Property	Description/Value
Probe fitting	ISO1/2" and NPT1/2" fittings included
Connector	M12/5
Weight	570 g (20.1 oz)
Materials	
Probe	AISI316L
Probe body	AISI316L
Cable jacket	FEP

7.5 TMP1 Specifications

Table 24 Measurement Performance

Property	Description/Value
Sensor	Pt100 RTD Class F0.1 IEC 60751
Measurement range	-70 ... +180 °C (-94 ... +356 °F)
Accuracy at +23 °C (+73.4 °F) ^{1) 2)}	±0.1 °C (±0.18 °F)

- 1) Defined against calibration reference
- 2) Exposing temperature sensor to temperatures outside -20 ... +150 °C (-4 ... +302 °F) may cause permanent additional deviation of ±0.1 °C (0.18 °F)

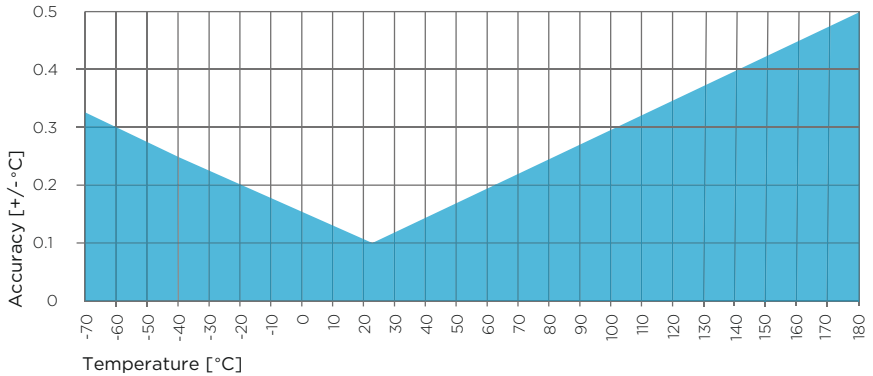

Figure 26 Tmp1 Temperature Measurement Accuracy over Full Range (Including Non-Linearity and Repeatability)

Table 25 SI Traceable Calibration

Property	Description/Value
Uncertainty of temperature calibration ($k = 2$)	± 0.1 °C (± 0.18 °F) at +23 °C (+73.4 °F)

Table 26 Operating Environment

Property	Description/Value
Operating temperature range for probe body	-40 ... +80 °C (-40 ... +176 °F)
Operating temperature range for probe head	-70 ... +180 °C (-94 ... +356 °F)
Operating environment	Suitable for outdoor use
IP rating	IP66
Electromagnetic compatibility	Complies with EMC standard EN61326-1, Industrial Environment

Table 27 Inputs and Outputs

Property	Description/Value
Operating voltage	15 ... 30 VDC
Current consumption	10 mA typical
Digital output	RS-485, non-isolated
Default serial settings	19200 bps N 8 2
Protocols	Modbus RTU

Property	Description/Value
Output parameters	Temperature, water vapor saturation pressure

Table 28 Mechanical Specifications

Property	Description/Value
Connector	M12/5
Weight	224 g (7.9 oz)
Materials	
Probe	AISI316L
Probe body	AISI316L
Cable jacket	FEP

7.6 Dimensions

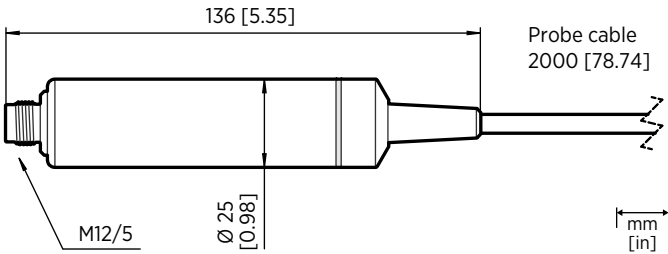

Figure 27 Probe Body Dimensions

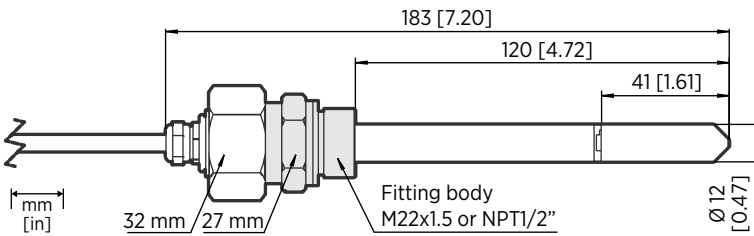

Figure 28 HMP4 Probe Head Dimensions

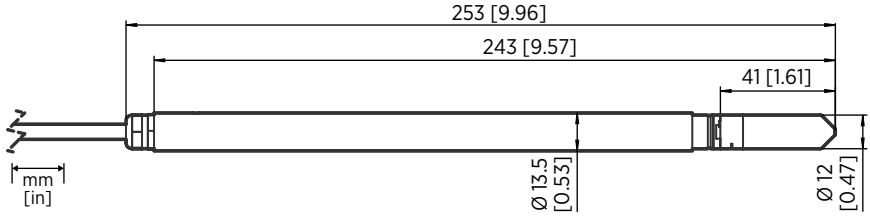

Figure 29 HMP5 Probe Head Dimensions

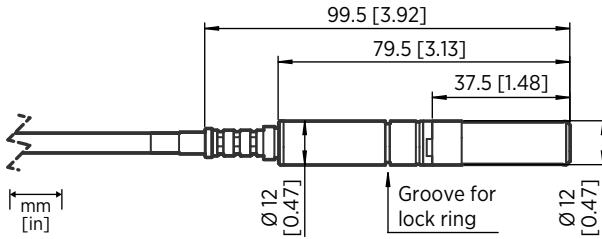

Figure 30 HMP7 Probe Head Dimensions

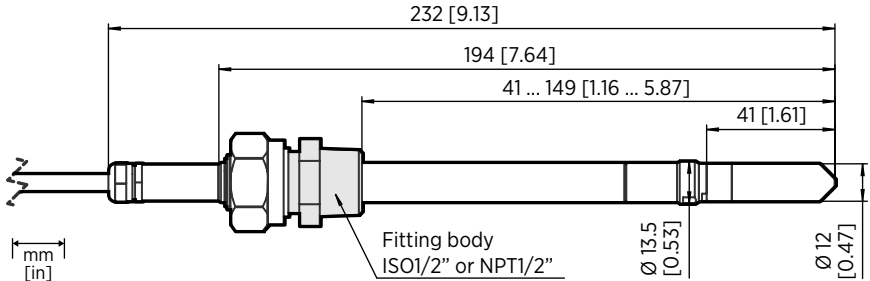

Figure 31 HMP8 Probe Head Dimensions

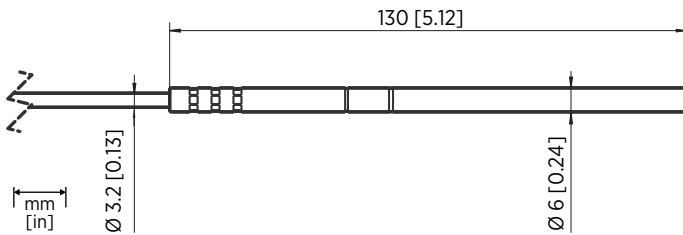

Figure 32 TMP1 Probe Head Dimensions

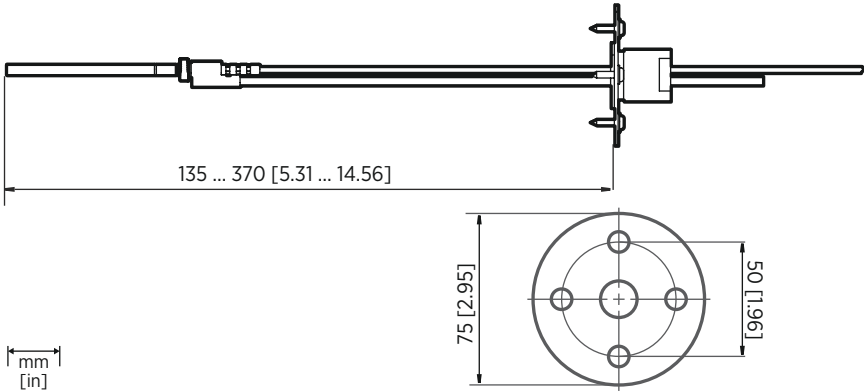

Figure 33 Optional Duct Kit 215003 Dimensions

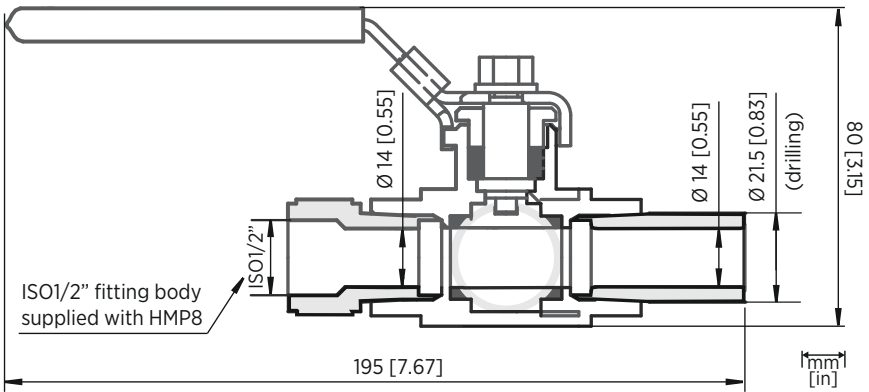

Figure 34 Optional Ball Valve Installation Kit Dimensions

7.7 Spare Parts and Accessories

HMP4

Table 29 Accessories

Description	Item Code
Transmitters	
Indigo 200 Series	See order form

Description	Item Code
Connection Cables	
Connection cable to Indigo (1 m)	INDIGOCABLE1M
Connection cable to Indigo (3 m)	INDIGOCABLE3M
Connection cable to Indigo (5 m)	INDIGOCABLE5M
Connection cable to Indigo (10 m)	INDIGOCABLE10M
Open wires 1.5 m	223263SP
Open wires 10 m	216546SP
Open wires and 90° plug	244669SP
Flat cable 1 m M12/5	CBL210493SP
USB PC connection cable ¹⁾	242659
Filters	
Sintered stainless steel filter ²⁾	HM47280SP
Stainless steel grid	HM47453SP
Metallized PPS plastic grid with stainless steel mesh filter	DRW010281SP
Metallized PPS plastic grid filter	DRW010276SP

1) *Vaisala Insight software for Windows available at www.vaisala.com/insight*

2) *Standard in delivery*

HMP5

Table 30 Accessories

Description	Item Code
Transmitters	
Indigo 200 Series	See order form
Connection Cables	
Connection cable to Indigo (1 m)	INDIGOCABLE1M
Connection cable to Indigo (3 m)	INDIGOCABLE3M
Connection cable to Indigo (5 m)	INDIGOCABLE5M
Connection cable to Indigo (10 m)	INDIGOCABLE10M
Open wires 1.5 m	223263SP
Open wires 10 m	216546SP

Description	Item Code
Open wires and 90° plug	244669SP
Flat cable 1 m M12/5	CBL210493SP
USB PC connection cable ¹⁾	242659
Filters	
Sintered stainless steel filter ²⁾	HM47280SP
Stainless steel grid	HM47453SP
Metallized PPS plastic grid with stainless steel mesh filter	DRW010281SP
Metallized PPS plastic grid filter	DRW010276SP
Accessories	
Mounting flange	210696

1) *Vaisala Insight software for Windows available at www.vaisala.com/insight*

2) *Standard in delivery*

HMP7

Table 31 Accessories

Description	Item Code
Transmitters	
Indigo 200	See order form
Connection Cables	
Connection cable to Indigo (1 m)	INDIGOCABLE1M
Connection cable to Indigo (3 m)	INDIGOCABLE3M
Connection cable to Indigo (5 m)	INDIGOCABLE5M
Connection cable to Indigo (10 m)	INDIGOCABLE10M
Open wires 1.5 m	223263SP
Open wires 10 m	216546SP
Open wires and 90° plug	244669SP
Flat cable 1 m M12/5	CBL210493SP
USB PC connection cable ¹⁾	242659
Filters	

Description	Item Code
Sintered stainless steel filter	HM47280SP
Stainless steel grid	HM47453SP
Metallized PPS plastic grid with stainless steel mesh filter ²⁾	DRW010281SP
Metallized PPS plastic grid filter	DRW010276SP
Accessories	
Duct installation kit for RH probe	210697
Solar radiation shield	DTR502B
Cable gland M20x1.5 with split seal	HMP247CG
Swagelok for 12 mm probe, 1/2" ISO thread	SWG12ISO12
Swagelok for 12 mm probe, 3/8" ISO thread	SWG12ISO38
Swagelok for 12 mm probe, 1/2" NPT thread	SWG12NPT12

1) *Vaisala Insight software for Windows available at www.vaisala.com/insight*

2) *Standard in delivery*

HMP8

Table 32 Accessories

Description	Item Code
Transmitters	
Indigo 200 Series	See order form
Connection Cables	
Connection cable to Indigo (1 m)	INDIGOCABLE1M
Connection cable to Indigo (3 m)	INDIGOCABLE3M
Connection cable to Indigo (5 m)	INDIGOCABLE5M
Connection cable to Indigo (10 m)	INDIGOCABLE10M
Open wires 1.5 m	223263SP
Open wires 10 m	216546SP
Open wires and 90° plug	244669SP
Flat cable 1 m M12/5	CBL210493SP
USB PC connection cable ¹⁾	242659
Filters	

Description	Item Code
Sintered stainless steel filter ²⁾	HM47280SP
Stainless steel grid	HM47453SP
Metallized PPS plastic grid with stainless steel mesh filter	DRW010281SP
Metallized PPS plastic grid filter	DRW010276SP
Accessories	
Ball valve 1/2" with ISO 1/2" welding joint	BALLVALVE-1

1) *Vaisala Insight software for Windows available at www.vaisala.com/insight*

2) *Standard in delivery*

TMP1

Table 33 Accessories

Description	Item Code
Transmitters	
Indigo 200 Series	See order form
Connection Cables	
Connection cable to Indigo (1 m)	INDIGOCABLE1M
Connection cable to Indigo (3 m)	INDIGOCABLE3M
Connection cable to Indigo (5 m)	INDIGOCABLE5M
Connection cable to Indigo (10 m)	INDIGOCABLE10M
Open wires 1.5 m	223263SP
Open wires 10 m	216546SP
Open wires and 90° plug	244669SP
Flat cable 1 m M12/5	CBL210493SP
USB PC connection cable ¹⁾	242659
Accessories	
Duct installation kit for T probe	215003
Swagelok for 6 mm probe 1/8" ISO thread	SWG6ISO18
Swagelok for 6 mm probe 1/8" NPT thread	SWG6NPT18

1) *Vaisala Insight software for Windows available at www.vaisala.com/insight*

Appendix A. Modbus Reference

A.1 Default Communication Settings

Table 34 Default Modbus Serial Communication Settings

Property	Description/Value
Serial bit rate	19200
Parity	None
Number of data bits	8
Number of stop bits	2
Flow control	None
Modbus device address	240

You can use up to ten probes on the same RS-485 line. You must configure each probe on the line to have a different Modbus address.

A.2 Function Codes

Table 35 Modbus Function Codes

Function Code (Decimal)	Function Code (Hexadecimal)	Name	Notes
03	03 _{hex}	Read Holding Registers	Class 0
16	10 _{hex}	Write Multiple Registers	Class 0
43 / 14	2B _{hex} / 0E _{hex}	Read Device Identification	

A.3 Data Encoding

In the data registers, the numeric values are available in one or two formats with separate register addresses: 32-bit IEEE floating point format and/or 16-bit signed integer format.

A.3.1 32-Bit Floating Point or Integer Format

Least-significant 16 bits of floating point or integer numbers are placed at the smaller Modbus address as specified in Open Modbus TCP Specification, Release 1.0. This is also known as "little-endian" or "Modicon" word order. Floating point values are represented in standard IEEE 32-bit floating point format.



Despite the specification, some Modbus masters may expect "big-endian" word order (most-significant word first). In such case, you must select "word-swapped" floating point format in your Modbus master for the Modbus registers of the device.

A "quiet NaN" value is returned for unavailable values. A quiet NaN is, for example, $7FC00000_{\text{hex}}$; however, the master should understand any NaN value.



A complete 32-bit floating point or integer value should be read and written in a single Modbus transaction.

A.3.2 16-Bit Integer Format

Some 16-bit integer values in the data registers are scaled to include the necessary decimals. The scaling factors for those values are shown in the register tables.

Table 36 16-bit Signed Integer Format Details

Value	Description
$0000_{\text{hex}} \dots 7FFE_{\text{hex}}$	Value in range 0 ... 32766
$8002_{\text{hex}} \dots FFFF_{\text{hex}}$	Value in range -32766 ... -1 (2's complement)
8000_{hex}	Value is not available (quiet NaN)



Some values may exceed the signed 16-bit range even in normal operation. To access such values, use the floating point registers instead.

A.4 Modbus Registers



CAUTION! Registers are numbered in decimal, starting from one. Register addresses in actual Modbus messages (Modbus Protocol Data Unit (PDU) are in hexadecimal and start from zero. Subtract 1 from the register number presented in this manual to get the address used in the Modbus message (for example, register number 1 corresponds to address 0_{hex} in the actual Modbus message).

Accessing unavailable (temporarily missing) measurement data does not generate an exception. “Unavailable” value (a quiet NaN for floating point data or 8000_{hex} for integer data) is returned instead. An exception is generated only for any access outside the applicable register ranges.

A.4.1 Measurement Data Registers

Table 37 Modbus Measurement Data Registers (Read-Only)

Register Number (Decimal)	Address (Hexadecimal)	Register Description	Data Format	Metric Unit
Floating Point Values				
1	0000 _{hex}	Relative humidity	32-bit float	%RH
3	0002 _{hex}	Temperature	32-bit float	°C
7	0006 _{hex}	Dew point temperature	32-bit float	°C
9	0008 _{hex}	Dew/frost point temperature	32-bit float	°C
11	000A _{hex}	Dew/frost point temperature at 1 atm	32-bit float	°C
13	000C _{hex}	Dew point temperature at 1 atm	32-bit float	°C
14	000E _{hex}	Absolute humidity	32-bit float	g/m ³
16	0010 _{hex}	Mixing ratio	32-bit float	g/kg
19	0012 _{hex}	Wet-bulb temperature	32-bit float	°C
21	0014 _{hex}	Water vapor concentration	32-bit float	ppm _v
23	0016 _{hex}	Water vapor pressure	32-bit float	hPa
25	0018 _{hex}	Water vapor saturation pressure	32-bit float	hPa
27	001A _{hex}	Enthalpy	32-bit float	kJ/kg
31	001E _{hex}	Dew point temperature difference	32-bit float	°C
33	0020 _{hex}	Absolute humidity at NTP	32-bit float	g/m ³
65	0040 _{hex}	Water vapor mass fraction	32-bit float	ppm _w

Integer Values				
257	0100 _{hex}	Relative humidity	16-bit signed integer	%RH * 100
258	0101 _{hex}	Temperature	16-bit signed integer	°C * 100
260	0103 _{hex}	Dew point temperature	16-bit signed integer	°C * 100
261	0104 _{hex}	Dew/frost point temperature	16-bit signed integer	°C * 100
262	0105 _{hex}	Dew/frost point temperature at 1 atm	16-bit signed integer	°C * 100
263	0106 _{hex}	Dew point temperature at 1 atm	16-bit signed integer	°C * 100
264	0107 _{hex}	Absolute humidity	16-bit signed integer	g/m ³ * 100
265	0108 _{hex}	Mixing ratio	16-bit signed integer	g/kg * 100
266	0109 _{hex}	Wet-bulb temperature	16-bit signed integer	°C * 100
267	010A _{hex}	Water vapor concentration	16-bit signed integer	ppm _v
268	010B _{hex}	Water vapor pressure	16-bit signed integer	hPa * 10
269	010C _{hex}	Water vapor saturation pressure	16-bit signed integer	hPa * 10
270	010D _{hex}	Enthalpy	16-bit signed integer	kJ/kg * 100
272	010F _{hex}	Dew point temperature difference	16-bit signed integer	°C * 10
273	0110 _{hex}	Absolute humidity at NTP	16-bit signed integer	g/m ³ * 100
289	0120 _{hex}	Water vapor mass fraction	16-bit signed integer	ppm _w

A.4.2 Configuration Registers

Table 38 Modbus Configuration Data Registers (Writable)

Register Number (Decimal)	Register Address (Hexadecimal)	Register Description	Data Format	Unit / Valid Range
General				
1287	0506 _{hex}	Extra heat on/off. Enables heating of humidity sensor when close to saturation. Measurement is disabled for the duration of heating and cooling.	16-bit boolean	0 = off (default) 1 = on
1289	0508 _{hex}	Probe heating on/off. Available on HMP7 model only. When on, relative humidity measurement is disabled unless temperature is written to register 0334 _{hex} from an external source.	16-bit boolean	0 = off (default) 1 = on
2561	0A00 _{hex}	User information	Text	Text string of 24 bytes in UTF-8 encoding
Compensation Setpoints				
769	0300 _{hex}	Pressure compensation setpoint	32-bit float	Unit: hPa Default: 1013.25 hPa
821	0334 _{hex}	Temperature compensation setpoint. If a value is written to this register, probe uses it when calculating relative humidity instead of its own measurement. When probe heating is in use, temperature must be written to this register to enable relative humidity measurement.	32-bit float	Unit: °C
Purge				
773	0304 _{hex}	Purge interval	32-bit float	Unit: min 10 ... 14400

Purge				
1283	0502 _{hex}	Interval purge on/off	16-bit boolean	0 = Off 1 = On
1284	0503 _{hex}	Startup purge on/off	16-bit boolean	0 = Off 1 = On
Filtering				
795	031A _{hex}	Measurement filtering factor	32-bit float	Range: 0.000 ... 1.000 1.000 = Reading shows 100% of the most recent measured value (no filtering, default) 0.01 ... 0.99 = Reading shows 1 ... 99% of the most recent measured value and part of the previous reading (filtering is applied). For example, "0.9" means that the filtered measurement reading = 90% of the most recent measured value + 10% of the previous reading.
1282	0501 _{hex}	Enable of disable measurement filtering using the user-defined filtering factor (register 031A _{hex})	16-bit boolean	0 = Off 1 = On
Communication				
1537	0600 _{hex}	Modbus address	16-bit integer	1 ... 247 Default: 240

Communication				
1538	0601 _{hex}	Bit rate	enum	0 = 300 1 = 600 2 = 1200 3 = 2400 4 = 4800 5 = 9600 6 = 19200 7 = 38400 8 = 57600 9 = 115200
1539	0602 _{hex}	Parity, data, stop bits	enum	0 = None, 8, 1 1 = None, 8, 2 2 = Even, 8, 1 3 = Even, 8, 2 4 = Odd, 8, 1 5 = Odd, 8, 2 (default: 1 = None, 8, 2)
1540	0603 _{hex}	Response delay	16-bit integer	Unit: ms Range: 0 ... 1000
Functions				
1542	0605 _{hex}	Restart device	16-bit function status	When writing to register: 1 = Restart the device

A.4.3 Device Identification Objects

Table 39 Device Identification Objects

Object Id (Decimal)	Object Id (Hexadecimal)	Object Name	Example Contents
0	00 _{hex}	VendorName	"Vaisala"
1	01 _{hex}	ProductCode	"HMP4"
2	02 _{hex}	MajorMinorVersion	Software version (for example "1.2.3")
3	03 _{hex}	VendorUrl	"http://www.vaisala.com/"

Object Id (Decimal)	Object Id (Hexadecimal)	Object Name	Example Contents
4	04 _{hex}	ProductName	"Humidity and Temperature Probe HMP4"
5	05 _{hex}	ModelName	Configuration code
6	06 _{hex}	UserApplicationName	User definable information text (see configuration register 0A00 _{hex})
128	80 _{hex}	SerialNumber	Serial number of the device (for example "K0710040")
129	81 _{hex}	CalibrationDate	Date of the factory calibration
130	82 _{hex}	CalibrationText	Information text of the factory calibration

A.4.4 Test Value Registers

Read the known test values from the test registers to verify the functionality of your Modbus implementation.

Table 40 Modbus Test Registers (Read-Only)

Register Number (Decimal)	Register Address (Hexadecimal)	Register Description	Data Format	Test value
7937	1F00 _{hex}	Signed integer test	16-bit integer	-12345
7938	1F01 _{hex}	Floating point test	32-bit float	-123.45
7940	1F03 _{hex}	Text string test	text	Text string "-123.45"

A.4.5 Modbus Communication Examples

Reading Relative Humidity Value



Device address used in the following examples is 240 (F0_{hex}).
 The values returned by the device differ depending on the ambient conditions and/or device settings. Your device might not return exactly same values.

Request		Response	
Bytes on the Line (Hexadecimal)	Description	Bytes on the Line (Hexadecimal)	Description
(silence for 3.5 bytes)	Start of Modbus RTU frame	(silence for 3.5 bytes)	Start of Modbus RTU frame
F0 _{hex}	Probe address	F0 _{hex}	Probe address
03 _{hex}	Function (Read Holding Registers)	03 _{hex}	Function (Read Holding Registers)
00 _{hex}	Register address	04 _{hex}	Number of data bytes
00 _{hex}		7A _{hex}	Value of first register (least significant word)
00 _{hex}	Number of 16-bit registers to read (2)	E1 _{hex}	
02 _{hex}		41 _{hex}	
D1 _{hex}	Modbus RTU checksum	F4 _{hex}	Modbus RTU checksum
2A _{hex}			
(silence for 3.5 bytes)	End of Modbus RTU frame	05 _{hex}	End of Modbus RTU frame
		06 _{hex}	
		(silence for 3.5 bytes)	End of Modbus RTU frame

Communication Description	
Register address	1 (1-based Modbus documentation format) = 0000 _{hex} (0-based format used in actual communication).
Data format	Two 16-bit Modbus registers interpreted as IEEE 754 binary32 floating point value, least significant word first.
Returned value	41F47AE1 _{hex} , which is binary32 representation of 30.56 (%RH).

Writing Pressure Compensation Value

Request		Response	
Bytes on the Line (Hexadecimal)	Description	Bytes on the Line (Hexadecimal)	Description
(silence for 3.5 bytes)	Start of Modbus RTU frame	(silence for 3.5 bytes)	Start of Modbus RTU frame
F0 _{hex}	Probe address	F0 _{hex}	Probe address
10 _{hex}	Function (Write Multiple Registers)	10 _{hex}	Function (Write Multiple Registers)
03 _{hex}	Register address	03 _{hex}	Register address
00 _{hex}		00 _{hex}	
00 _{hex}	Number of registers to write (2)	00 _{hex}	Number of 16-bit registers written (2)
02 _{hex}		02 _{hex}	
04 _{hex}	Number of data bytes	AD _{hex}	Modbus RTU checksum
6E _{hex}	Value for first register (least significant word)	54 _{hex}	
14 _{hex}		Value for second register (least significant word)	(silence for 3.5 bytes)
44 _{hex}	75 _{hex}		
75 _{hex}	Modbus RTU checksum	<div style="border: 1px solid gray; padding: 10px;">  <p>The response to a write function informs that the function was correctly received by the device. It does not guarantee that the written value was accepted by the device (for example, in case out-of-range values).</p> <p>To verify that the value was really accepted by the device, read the register value after writing.</p> </div>	
AB _{hex}			
4E _{hex}			
(silence for 3.5 bytes)	End of Modbus RTU frame		

Communication Description	
Register address	769 (1-based Modbus documentation format) = 0300 _{hex} (0-based format used in actual communication).

Communication Description	
Data format	Two 16-bit Modbus registers interpreted as IEEE 754 binary32 floating point value, least significant word first.
Value to write	44756E14 _{hex} = 981.72 (hPa)

Online Store

Spare parts, accessories, and calibration and repair products are available online at store.vaisala.com.

Warranty

For standard warranty terms and conditions, see www.vaisala.com/warranty.

Please observe that any such warranty may not be valid in case of damage due to normal wear and tear, exceptional operating conditions, negligent handling or installation, or unauthorized modifications. Please see the applicable supply contract or Conditions of Sale for details of the warranty for each product.

Technical Support



Contact Vaisala technical support at helpdesk@vaisala.com. Provide at least the following supporting information:

- Product name, model, and serial number
- Name and location of the installation site
- Name and contact information of a technical person who can provide further information on the problem

For more information, see www.vaisala.com/support.

Recycling



Recycle all applicable material.



Follow the statutory regulations for disposing of the product and packaging.

VAISALA

www.vaisala.com

