

LMK 331



Screw-In Transmitter

Ceramic Sensor

accuracy according to IEC 60770:
0.5 % FSO

Nominal pressure

from 0 ... 400 mbar up to 0 ... 60 bar

Output signals

2-wire: 4 ... 20 mA

3-wire: 0 ... 20 mA / 0 ... 10 V

others on request

Special characteristics

- ▶ pressure port G 3/4" flush for pasty and impurified media
- ▶ pressure port PVDF for aggressive media





Optional versions

- ▶ IS-version (only for 4 ... 20mA / 2-wire): Ex ia = intrinsically safe for gases and dusts
- ▶ SIL 2 application according to IEC 61508 / IEC 61511
- ▶ customer specific versions

The screw-in transmitter LMK 331 has been especially designed for level and process measurement and is suitable for pressure measurement of liquids, oils and gases. Usage in more viscous or polluted media is possible because of the semi-flush pressure sensor.

For the usage in aggressive media we recommended the version with PVDF pressure port. Additional features like e.g. an intrinsically safe version or a functionally safe version (SIL 2) complete the range of possibilities.

Preferred areas of use are

-  Plant and Machine Engineering
-  Energy Industry
-  Environmental Engineering (water – sewage – recycling)
-  Medical Technology



Input pressure range													
Nominal pressure gauge	[bar]	0.4	0.6	1	1.6	2.5	4	6	10	16	25	40 ¹	60 ¹
Level	[mH ₂ O]	4	6	10	16	25	40	60	100	160	250	400	600
Overpressure	[bar]	1	2	2	4	4	10	20	20	40	40	100	200
Burst pressure	[bar]	2	4	4	5	7,5	12	25	30	50	50	120	250
Vacuum resistance	[bar]	P _N ≥ 1 bar: unlimited vacuum resistance P _N < 1 bar: on request											

¹ only possible with stainless steel pressure port

Output signal / Supply		
Standard	2-wire:	4 ... 20 mA / V _S = 8 ... 32 V _{DC} SIL-version: V _S = 14 ... 28 V _{DC}
Option IS-protection ²	2-wire:	4 ... 20 mA / V _S = 10 ... 28 V _{DC} SIL-version: V _S = 14 ... 28 V _{DC}
Optionen 3-wire	3-wire:	0 ... 20 mA / V _S = 14 ... 30 V _{DC} 0 ... 10 V / V _S = 14 ... 30 V _{DC}

² IS-protection not possible with plastic pressure port

Performance	
Accuracy ³	≤ ± 0.5 % FSO
Permissible load	current 2-wire: R _{max} = [(V _S - V _{S min}) / 0.02 A] Ω current 3-wire: R _{max} = 500 Ω voltage 3-wire: R _{min} = 10 kΩ
Influence effects	supply: 0.05 % FSO / 10 V load: 0.05 % FSO / kΩ
Response time	2-wire: ≤ 10 msec 3-wire: ≤ 3 msec
Long term stability	≤ ± 0.3 % FSO / year at reference conditions

³ accuracy according to IEC 60770 – limit point adjustment (non-linearity, hysteresis, repeatability)

Thermal effects (Offset and Span) / Permissible Temperatures	
Thermal error	≤ ± 0.2 % FSO / 10 K
in compensated range	-25 ... 85 °C
Permissible temperatures	medium: -40 ... 125 °C electronics / environment: -25 ... 85 °C storage: -40 ... 100 °C

Electrical protection	
Short-circuit protection	permanent
Reverse polarity protection	no damage, but also no function
Electromagnetic compatibility	emission and immunity according to EN 61326

Mechanical stability	
Vibration	10 g RMS (25 ... 2000 Hz) according to DIN EN 60068-2-6
Shock	500 g / 1 msec according to DIN EN 60068-2-27

Materials			
Pressure port / housing	standard:	pressure port	housing
	options for P _N ≤ 25 bar:	stainless steel 1.4404 (316L) PVDF	stainless steel 1.4404 (316L) PVDF
Option compact field housing	stainless steel 1.4305 with cable gland brass nickel plated others on request		
Seals	standard: FKM options: EPDM	others on request	
Diaphragm	ceramics Al ₂ O ₃ 96 %		
Media wetted parts	pressure port, seals, diaphragm		

Explosion protection (only for 4 ... 20 mA / 2-wire)	
Approval DX19-LMK 331 only for stainless steel pressure port	IBExU 10 ATEX 1068 X / IECEx IBE 12.0027X zone 0: II 1G Ex ia IIC T4 Ga zone 20: II 1D Ex ia IIIC T 85°C Da
Safety technical maximum values	U _i = 28 V, I _i = 93 mA, P _i = 660 mW, C _i ≈ 0 nF, L _i ≈ 0 μH, the supply connections have an inner capacity of max. 27 nF to the housing
Permissible temperatures for environment	in Zone 0: -20 ... 60 °C with p _{atm} 0.8 bar up to 1.1 bar in Zone 1 or higher: -25 ... 70 °C
Connecting cables (by factory)	cable capacitance: signal line/shield also signal line / signal line: 160 pF/m cable inductance: signal line /shield also signal line / signal line: 1 μH/m

Miscellaneous	
Option SIL 2 application	according to IEC 61508 / IEC 61511
Current consumption	signal output current: max. 25 mA signal output voltage: max. 7 mA
Weight	approx. 150 g
Installation position	any
Operational life	> 100 x 10 ⁶ pressure cycles
CE-conformity	EMC Directive: 2014/30/EU
ATEX Directive	2014/34/EU

Wiring diagrams

2-wire-system (current)

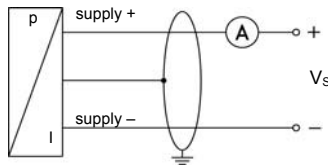

3-wire-system (current / voltage)

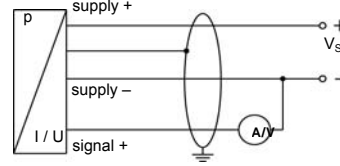

Pin configuration

Electrical connections	ISO 4400	Binder 723 (5-pin)	M12x1 / metal (4-pin)	cable colours (IEC 60757)
Supply +	1	3	1	wh (white)
Supply -	2	4	2	bn (brown)
Signal + (only for 3-wire)	3	1	3	gn (green)
Shield	ground contact	5	4	gnye (green-yellow)

Electrical connections (dimensions in mm)

standard

option

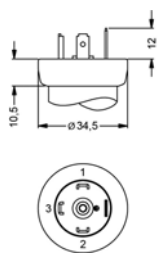

ISO 4400 (IP 65)

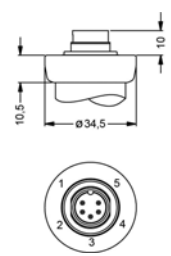

Binder Series 723 5-pin (IP 67)

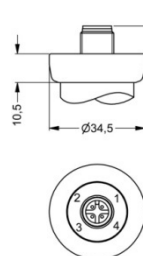

M12x1 4-pin (IP 67)

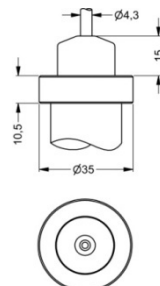

cable outlet with PVC cable (IP 67)⁴

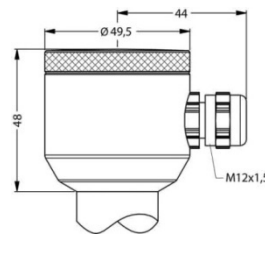

compact field housing (IP 67)

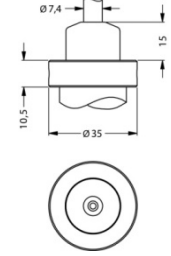

cable outlet, cable with ventilation tube (IP 68)⁵

⇒ universal stainless steel housing 1.4404 with cable gland M20x1.5 (ordering code 880) and other versions on request

⁴ standard: 2 m PVC-cable without ventilation tube (permissible temperature: -5 ... 70°C)

⁵ different cable types and length available, permissible temperature depends on kind of cable

Mechanical connection (dimensions in mm)

standard

standard for SIL- and SIL-Ex-version

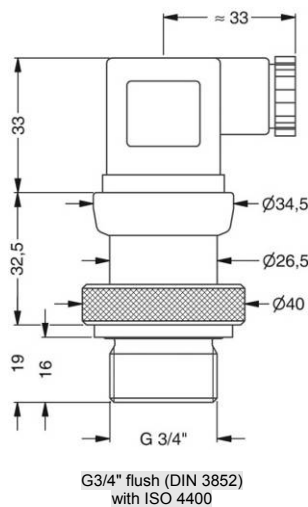

G3/4" flush (DIN 3852) with ISO 4400

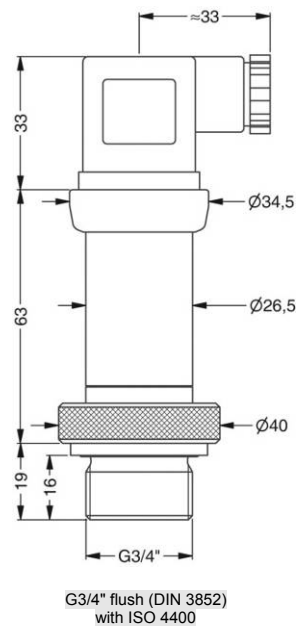

G3/4" flush (DIN 3852) with ISO 4400

© 2016 BD|SENSORS GmbH – The specifications given in this document represent the state of engineering at the time of publishing. We reserve the right to make modifications to the specifications and materials.

