

Series EHP 31

11600/20300 PSI

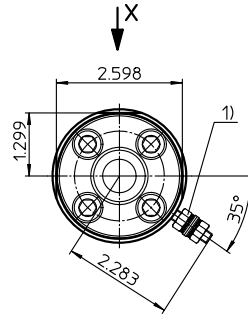

filter with clogging indicator

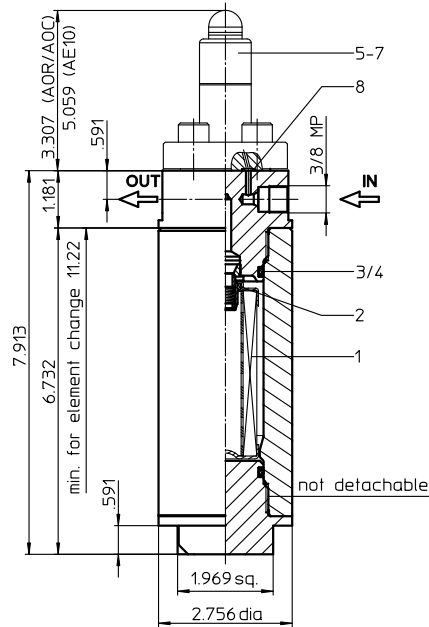

view X

filter with blind flange
(execution without clogging indicator)

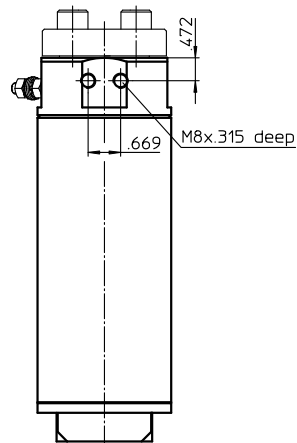

1) Connect the stand grounding tab to a suitable earth ground point.

Weight: approx. 6.5 lbs
Dimensions: inches

Designs and performance values are subject to change.

EDV 09/15



Powering Business Worldwide

Stainless Steel-Pressure Filter Series EHP 31 11600/20300 PSI

Description:

Stainless steel pressure filter series EHP 31 have a working pressure up to 11600 or 20300 PSI. Pressure peaks can be absorbed with a sufficient safety margin. The HP-filter is in-line mounted.

The filter element consists of star-shaped, pleated filter material, which is supported on the inside by a perforated core tube and is bonded to the end caps with a high-quality adhesive. The flow direction is from outside to inside. Filter elements are available down to 4 $\mu\text{m}_{(c)}$.

Eaton filter elements are known for high intrinsic stability and an excellent filtration capability, a high dirt-retaining capacity and a long service life.

Eaton filter elements are suitable for all petroleum based fluids, HW-emulsions, most synthetic hydraulic fluids and lubrication oils.

Eaton filter elements are available up to a pressure resistance of Δp 2320 PSI and a rupture strength of Δp 3625 PSI.

The bypass valve is integrated into the filter head.

After reaching the bypass pressure setting, the bypass valve will send unfiltered partial flow around the filter.

1. Type index:

1.1. Complete filter: (ordering example)

EHP. 31. 10VG. HR. E. P. VA. NPT. 3. -. VA. -. 800

1	2	3	4	5	6	7	8	9	10	11	12	13
1	series: EHP = stainless steel-pressure filter											
2	nominal size: 31											
3	filter-material and filter-fineness: 80G, 40G, 25G, 10G stainless steel wire mesh 25VG, 16VG, 10VG, 6VG, 3VG microglass											
4	filter element collapse rating: 30 = Δp 435 PSI HR = Δp 2320 PSI (rupture strength Δp 3625 PSI)											
5	filter element design: E = single-end open											
6	sealing material: P = Nitrile (NBR) V = Viton (FPM)											
7	filter element specification: (see catalog) - = standard VA = stainless steel ISO6 = for HFC application, see sheet-no. 31601											
8	process connection: UG2 = autoclave medium pressure NPT = thread connection											
9	process connection size: 2 = MP 3/8" (9/16"-18UNF) 3 = NPT 1/2											
10	internal valve: - = without S1 = with by-pass valve Δp 51 PSI S2 = with by-pass valve Δp 102 PSI											
11	filter housing specification: VA = stainless steel											
12	clogging indicator or clogging sensor: - = without AOR = visual, see sheet-no. 46041 AOC = visual, see sheet-no. 61565 AE10 = visual-electric, see sheet-no. 46042											
13	pressure level: 800 = max. operating pressure 11600 PSI 1400 = max. operating pressure 20300 PSI											

To add an indicator to your filter, use the corresponding indicator data sheet to find the indicator details and add them to the filter assembly model code.

1.2. Filter element: (ordering example)

01E. 30. 10VG. HR. E. P. VA

1	2	3	4	5	6	7
1	series: 01E. = filter element according to company standard					
2	nominal size: 30					
3	-	7	see type index-complete filter			

Technical data:

design temperature:	14 °F to +212 °F				
operating temperature:	14 °F to +176 °F				
operating medium:	mineral oil, other media on request				
max. operating pressure:	<table border="1"> <tr> <td>11600 PSI</td> <td>20300 PSI</td> </tr> </table>	11600 PSI	20300 PSI		
11600 PSI	20300 PSI				
test pressure:	<table border="1"> <tr> <td>16600 PSI</td> <td>29000 PSI</td> </tr> </table>	16600 PSI	29000 PSI		
16600 PSI	29000 PSI				
process connection:	thread connection				
housing material:	<table border="1"> <tr> <td>EN10088-3 - 1.4462</td> <td>11600 PSI</td> </tr> <tr> <td>EN10088-3 - 1.4418 + QT900</td> <td>20300 PSI</td> </tr> </table>	EN10088-3 - 1.4462	11600 PSI	EN10088-3 - 1.4418 + QT900	20300 PSI
EN10088-3 - 1.4462	11600 PSI				
EN10088-3 - 1.4418 + QT900	20300 PSI				
sealing material:	Nitrile (NBR) or Viton (FPM), other materials on request				
installation position:	vertical				

Pressure stage 11600: Classified under the Pressure Equipment Directive 2014/68/EC for mineral oil (fluid group 2), Article 4, Para. 3.
 Pressure stage 20300: Classified under the Pressure Equipment Directive 2014/68/EC for mineral oil (fluid group 2), Article 4, Para. 1.1.b)
 Category I (Modul A)
 Classified under ATEX Directive 2014/34/EC according to specific application (see questionnaire sheet-no. 34279-4).

Pressure drop flow curves:

Filter calculation/sizing

The pressure drop of the assembly at a given flow rate Q is the sum of the housing Δp and the element Δp and is calculated as follows:

$$\Delta p_{assembly} = \Delta p_{housing} + \Delta p_{element}$$

$$\Delta p_{housing} = (\text{see } \Delta p = f(Q) - \text{characteristics})$$

$$\Delta p_{element} (PSI) = Q (GPM) \times \frac{MSK}{1000} \left(\frac{PSI}{GPM} \right) \times \nu (SUS) \times \frac{\rho}{0.876} \left(\frac{kg}{dm^3} \right)$$

For ease of calculation our Filter Selection tool is available online at www.eatonpowersource.com/calculators/filtration/

Material gradient coefficients (MSK) for filter elements

The material gradient coefficients in psi/gpm apply to mineral oil (HLP) with a density of 0.876 kg/dm³ and a kinematic viscosity of 139 SUS (30 mm²/s). The pressure drop changes proportionally to the change in kinematic viscosity and density.

EHP	VG					G		
	3VG	6VG	10VG	16VG	25VG	25G	40G	80G
31	12.554	8.716	5.580	4.794	3.275	0.2539	0.2369	0.1623

Symbols:

filter without internal valve

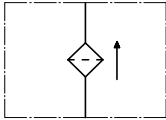

filter with by-pass valve

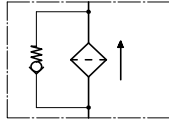

filter with visual clogging indicator

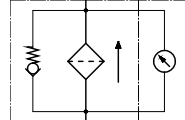

filter with electrical clogging indicator

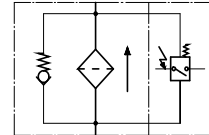

Spare parts:

item	qty.	designation	dimension	article-no.	
1	1	filter element	01E.30....	328344	
2	1	O-ring	11 x 3	312603 (NBR)	312727 (FPM)
3	1	O-ring	34 x 3	330601 (NBR)	340165 (FPM)
4	2	support ring	40 x 2,6 x 1	330602	
5	1	clogging indicator, visual	AOR.46041	see sheet-no. 46041	
6	1	clogging indicator, visual	AOC.61565	see sheet-no. 61565	
7	1	clogging indicator, electric	AE.10.46042	see sheet-no. 46042	
8	2	O-ring (only with execution clogging indicator)	4 x 1,5	326913 (NBR)	329675 (FPM)

Test methods:

Filter elements are tested according to the following ISO standards:

ISO 2941	Verification of collapse/burst resistance
ISO 2942	Verification of fabrication integrity
ISO 2943	Verification of material compatibility with fluids
ISO 3723	Method for end load test
ISO 3724	Verification of flow fatigue characteristics
ISO 3968	Evaluation of pressure drop versus flow characteristics
ISO 16889	Multi-pass method for evaluating filtration performance

North America

44 Apple Street
Tinton Falls, NJ 07724
Toll Free: 800 656-3344
(North America only)
Tel: +1 732 212-4700

Europe/Africa/Middle East

Auf der Heide 2
53947 Nettersheim, Germany
Tel: +49 2486 809-0

Friedensstraße 41
68804 Altlußheim, Germany
Tel: +49 6205 2094-0

An den Nahewiesen 24
55450 Langenlonsheim, Germany
Tel: +49 6704 204-0

China

No. 3, Lane 280,
Linhong Road
Changning District, 200335
Shanghai, P.R. China
Tel: +86 21 5200-0099

Singapore

4 Loyang Lane #04-01/02
Singapore 508914
Tel: +65 6825-1668

Brazil

Av. Julia Gaioli, 474 – Bonsucesso
07251-500 – Guarulhos, Brazil
Tel: +55 11 2465-8822

For more information, please
email us at filtration@eaton.com
or visit www.eaton.com/filtration

© 2015 Eaton. All rights reserved. All trademarks and registered trademarks are the property of their respective owners. All information and recommendations appearing in this brochure concerning the use of products described herein are based on tests believed to be reliable. However, it is the user's responsibility to determine the suitability for his own use of such products. Since the actual use by others is beyond our control, no guarantee, expressed or implied, is made by Eaton as to the effects of such use or the results to be obtained. Eaton assumes no liability arising out of the use by others of such products. Nor is the information herein to be construed as absolutely complete, since additional information may be necessary or desirable when particular or exceptional conditions or circumstances exist or because of applicable laws or government regulations.