

NUFLO™

Scanner® 2000 microEFM for FOUNDATION™ Fieldbus

Hardware User Manual



Important Safety Information

Symbols and Terms Used in this Manual



WARNING: This symbol identifies information about practices or circumstances that can lead to personal injury or death, property damage, or economic loss.

CAUTION: Indicates actions or procedures which if not performed correctly may lead to personal injury or incorrect function of the instrument or connected equipment.

Important: Indicates actions or procedures which may affect instrument operation or may lead to an instrument response which is not planned.

Symbols Marked on Equipment



Attention! Refer to manual



Protective (earth) ground

Technical Support Contact Information

Cameron
Measurement Systems Division
14450 John F. Kennedy Blvd.
Houston, TX 77032
Phone: 1-800-654-3760; 281-582-9500
Fax: 281-582-9599

NuFlo and ModWorX are trademarks of Cameron International Corporation (“Cameron”).

FOUNDATION is a trademark of the Fieldbus Foundation.

Scanner and Barton are registered trademarks of Cameron.

Modbus is a registered trademark of the Modbus Organization, Inc.

Flow-Cal is a registered trademark of Flow-Cal, Inc.

Windows is a registered trademark of Microsoft Corporation.

Acrobat Reader is a registered trademark of Adobe Systems Incorporated.

© 2013 Cameron International Corporation (“Cameron”). All information contained in this publication is confidential and proprietary property of Cameron. Any reproduction or use of these instructions, drawings, or photographs without the express written permission of an officer of Cameron is forbidden.

All Rights Reserved.
Printed in the United States of America.

Manual No. 9A-30165035, Rev. 03
April 2013

Contents

Important Safety Information	ii
Section 1—Introduction	7
Measurement Capabilities	7
Hardware	8
Hardware Options	10
Electrical Safety Ratings	10
Device Configuration	10
Configuration for Modbus Communications	10
Configuration for Fieldbus Communications	11
Specifications	11
Table 1.1—Scanner 2000 microEFM Specifications	11
Flow Rate and Fluid Property Calculations	16
Natural Gas	16
Steam.....	16
Compensated Liquid	17
Uncompensated Liquid	17
Section 2—Installing the Scanner 2000.....	19
Overview.....	19
Control System Components	19
Hazardous Area Installations	20
Wiring Considerations in Hazardous Areas	20
Pressure Safety Precautions	20
Table 2.1—MVT Pressure Limits, Approvals and Bolt Specifications	21
Mounting Options	21
Best Practices for Orifice and Cone Meter Installation	23
Installation Procedure—Direct Mount to Orifice Meter or Cone Meter.....	24
Installation Procedure—Remote Mount to Orifice Meter or Cone Meter	25
Measuring Natural Gas via a Turbine Meter.....	27
Best Practices	27
Installation Procedure—Remote Mount to a Turbine Meter.....	27
Measuring Steam via a Differential Pressure Meter	29
Best Practices	29
Installation Procedure—Remote Mount to Orifice Meter or Cone Meter	30
Measuring Liquid via a Differential Pressure Meter	33
Best Practices	33
Installation Procedure—Direct Mount to Orifice Meter or Cone Meter.....	34
Installation Procedure—Remote Mount to Orifice Meter or Cone Meter	35
Measuring Liquid via a Turbine Meter	38
Best Practices	38
Installation Procedure—Direct Mount to a Turbine Meter	38
Performing a Manifold Leak Test	39
Zero Offset (Static Pressure or Differential Pressure).....	39
Static Pressure Calibration and Verification.....	40
Differential Pressure Calibration and Verification.....	41
Placing the Scanner into Operation	42
Industry Standard Compliance	42
Table 2.2—Industry Standards for Orifice Meters	43
Industry Standards for Cone Meters	43
Table 2.3—Industry Standards for Turbine Meters	44
Table 2.4—Industry Standards for Fluid Properties	44

Section 3—Wiring the Scanner 2000	45
Field Wiring Connections.....	45
Fieldbus Cable	45
Basic Wiring.....	46
Grounding Procedures	47
Power Supply Wiring	48
Lithium Battery Pack	48
FOUNDATION™ Fieldbus Power Supply	49
Input Wiring	50
Turbine Flowmeter Input	50
RTD Input.....	51
Output Wiring.....	52
Digital Output (Pulse or Alarm)	52
RS-485 Output—Computer Connection	53
Section 4—Scanner 2000 Configuration and Operation.....	55
Configuring with ModWorX Pro Software	55
Configuring with Keypad.....	55
Entering the Slave Address.....	57
Entering the Baud Rate.....	57
Editing the Date and Time.....	58
Editing the Contract Hour.....	59
Editing the Plate Size.....	60
Navigating the Display.....	60
Viewing Real-Time Measurements	60
Viewing Daily and Hourly Logs	61
Password-Protected Security	61
Section 5—Fieldbus Configuration and Operation	63
Overview.....	63
Device Description.....	63
Block Descriptions	63
Block Modes	63
Resource Block.....	64
Transducer Block	64
Analog Input (AI) Function Blocks	64
Device Identification	65
Device ID	65
Physical Device (PD) Tag.....	65
Node Address	65
Configuring Fieldbus Communications.....	66
Communications Test.....	66
Configuring AI Blocks.....	66
Control Loop Design	68
Fieldbus Operations	68
Engineering Units.....	68
Status	68
Fieldbus Troubleshooting	69
General Errors	69
Communication Faults	70
Section 6—Scanner 2000 Maintenance	71
Lithium Battery Pack Replacement	71
Board Replacement.....	73
Main Board.....	73

Fieldbus Interface Board	77
Fieldbus Module	78
Keypad Replacement	78
MVT Replacement	79
Section 7—Spare Parts	81
Table 7.1—Scanner 2000 microEFM Spare Parts	81
Table 7.2—Scanner 2000 microEFM Optional Parts	82
Table 7.3—Multi-Variable Transmitters	82
Appendix A—Scanner 2000 Hardware Options	A-1
External Communications Adapter (9A-90017004)	A-1
Communications Adapter Installation (for adapters purchased separately from a Scanner 2000)	A-3
Pole-Mounting Kit (Part No. 9A-30028005)	A-3
Pole-Mount Installation	A-3
Terminal Housing (Part No. 2296352-01)	A-4
Appendix B—Lithium Battery Information	B-1
Transportation Information	B-1
Lithium Battery Disposal	B-1
Material Safety Data Sheet	B-2
Appendix C—Fieldbus Communications Protocol	C-1
Device Properties	C-1
Parameter Tables	C-1
Table C.1—Resource Block Parameters	C-1
Table C.2—Transducer Block Parameters	C-3
Table C.3—Analog Input Block Parameters	C-5
Table C.4—Transducer Error (XD_Error) and Block Alarm Codes	C-7
Control Registers	C-7
Table C.5—Control Registers	C-7
Unit Conversion	C-8
Table C.6—Unit Conversions for XD Scale	C-8

Section 1—Introduction

The NuFlo™ Scanner® 2000 microEFM for FOUNDATION™ Fieldbus ([Figure 1.1, page 8](#)) is a FISCO-certified flow computer that communicates via both RTU Modbus® and H1 fieldbus protocol. The device computes volumes of gas, liquid and steam using a differential pressure or pulse output from a primary metering device and makes the data available for download via Modbus communications.

When properly configured, the device converts values from predefined Modbus process variable registers to FOUNDATION™ fieldbus signals for use in building fieldbus control strategies. Additionally, other input values, flow volumes, and calculations can be read by a fieldbus host and recorded. For a complete list of parameters supported by the device, see the Foundation™ Fieldbus Protocol Manual for Scanner 2000.

The Modbus to FOUNDATION™ fieldbus conversion is made possible by an integrated fieldbus module. The module is connected to the Scanner 2000 main circuitry by way of a second “interface” board which receives the power/communications input from the fieldbus network, and facilitates communications between the main board and the fieldbus module. The three boards, a switchplate with display, and a lithium battery pack are housed inside a compact aluminum alloy enclosure. The device is rated for intrinsic safety, and is ATEX approved for use in hazardous areas.

A customer-supplied fieldbus power supply is the primary power source. However, should the primary power supply be lost, the lithium battery pack independently powers the unit to sustain data collection.

Static pressure and differential pressure inputs are supplied via an integral multi-variable transmitter. The Scanner 2000 also supports inputs for process temperature (RTD) and turbine signals, a digital output, and an optional external communications adapter. For a complete list of specifications, see [Table 1.1, page 11](#).

The Scanner 2000’s Modbus parameters are configured using ModWorX Pro, a full-featured software application supplied with every Scanner 2000 shipment, providing on-screen tools for configuring hardware and flow calculations, calibrating inputs, and collecting and viewing flow history. Basic settings can also be changed using the keypad on the front of the instrument. See [Section 4—Scanner 2000 Configuration and Operation, page 55](#), for details.

Fieldbus communications are configured using a customer-supplied configuration tool. See [Section 5—Fieldbus Configuration and Operation, page 63](#), for instructions on configuring FOUNDATION™ fieldbus parameters.

Note The Scanner 2000 for FOUNDATION™ Fieldbus will be referred to as simply Scanner 2000 throughout this document.

Measurement Capabilities

The Scanner 2000 microEFM measures and computes standard volumes of gas, steam, petroleum liquids, and generic liquids with a high degree of accuracy. These measurements can be combined with a process temperature input to yield compensated liquid measurements as well.

Gas, liquid, and steam measurements are typically based on the differential pressure output of an orifice plate, cone meter, or averaging pitot tube (such as Annubar®), or the linear pulse output of a turbine, positive displacement or vortex flowmeter.

The Scanner 2000 reliably supports AGA-3, ISO-5167 liquid measurement, and AGA-7 gas measurement.

When liquid measurement is the goal and pressure inputs are not required, simply purchase the Scanner 2000 without the MVT and mount it directly to a liquid turbine meter, then install an RTD in the flow line for temperature compensation. The Scanner 2000 uses algorithms based on AGA-7 principles to give accurate measurement of API liquids and other generic liquids..

Hardware

The standard Scanner 2000 microEFM features an enclosure with two conduit openings for signal cable, a large LCD, a three-button keypad, integral multi-variable transmitter with integral vent plugs, and a lithium double-D cell battery pack (Figure 1.1, page 8). MVTs are available in NACE and non-NACE models, and with bottom ports (gas measurement) and side ports (liquid and steam measurement). Alternatively, Scanner 2000 configurations are available for direct connection to a turbine meter, which is ideal for applications that do not require pressure measurement.

The Scanner 2000 microEFM is powered by a customer-provided FISCO-certified power supply. The internal lithium battery pack provides backup power.



WARNING: EXPLOSION RISK. Housing temperature must not exceed 70°C (158°F). Excessive temperatures, which could result from ambient conditions combined with radiated and conductive heat from the process, could cause the internal lithium battery to ignite or explode.

For battery handling instructions, see [Appendix B—Lithium Battery Information](#).

The main circuit board offers a turbine input, a communications port, an RTD input, and a digital output. Wiring diagrams are provided in [Section 3, page 45](#).

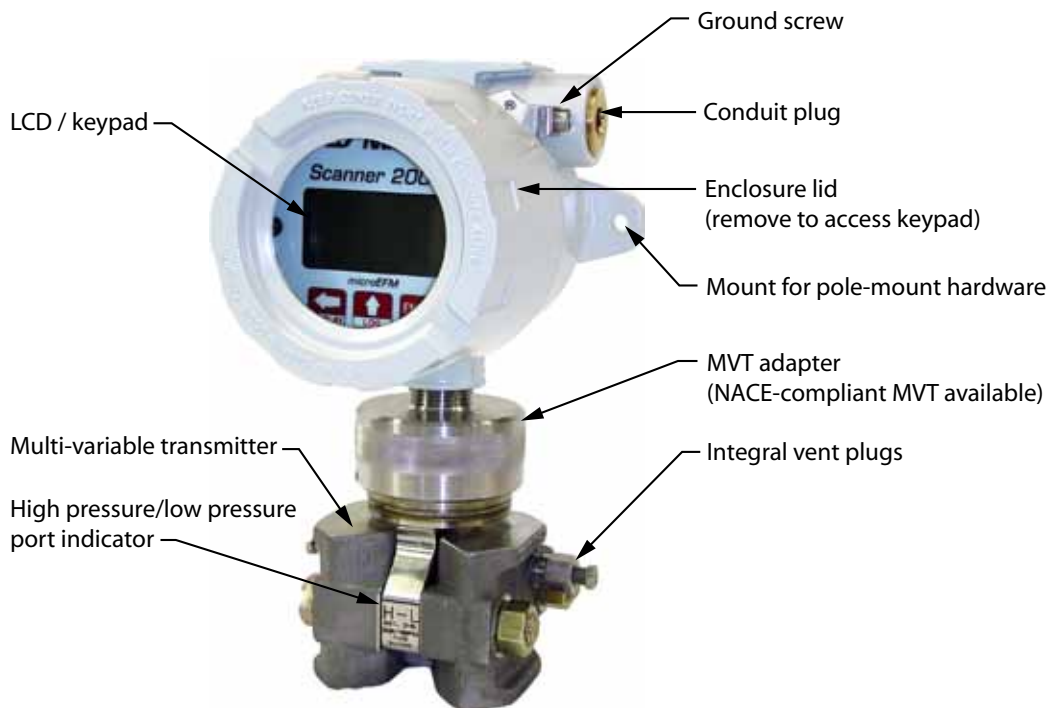

Figure 1.1—Scanner 2000 microEFM with integral MVT



Figure 1.2—Scanner 2000 microEFM with turbine meter adapter

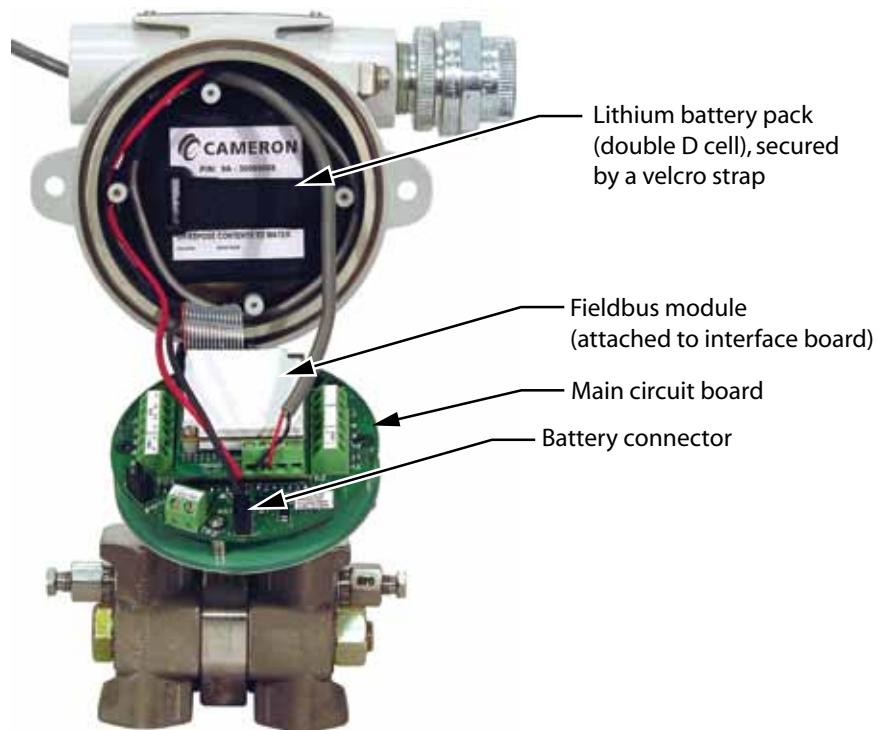

Figure 1.3— Scanner 2000 microEFM, internal view

Hardware Options

Several hardware options are available for customizing the Scanner 2000 to a user's specific needs. They include:

- communications adapter for enabling a quick connection to a laptop computer
- pole-mounting kit for mounting the Scanner 2000 to a 2-in. pole
- terminal housing that expands the number of input cables that can be connected to the Scanner 2000

See [Appendix A—Scanner 2000 Hardware Options, page A-1](#), for details.

Electrical Safety Ratings

Each device is labeled with a serial tag that identifies the product by model number and serial number and identifies the maximum operating pressure, working pressure, and differential pressure of the integral MVT (Figure 1.4). A description of the electrical protection afforded by SIRA certification and associated safety markings is also provided in Figure 1.4.

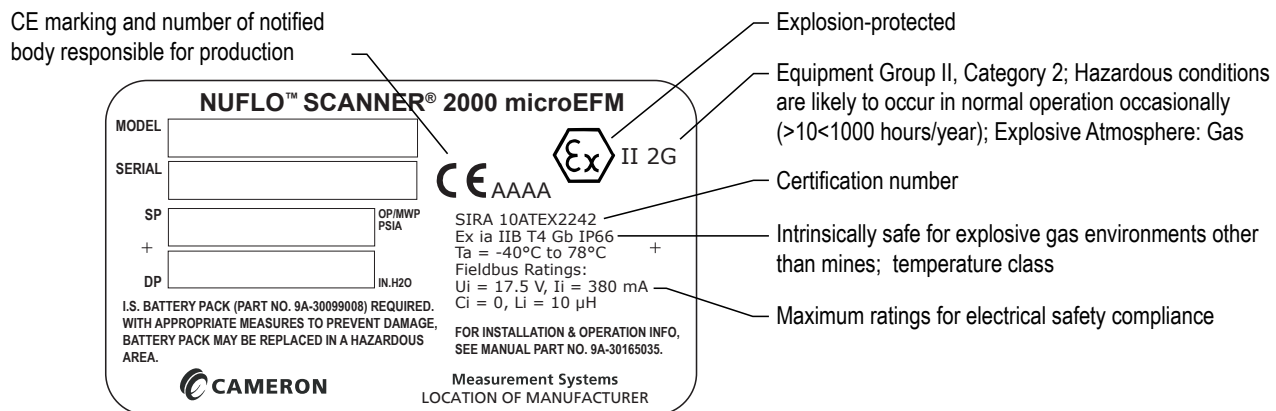

Figure 1.4—Device serial tag

Device Configuration

Before a Scanner 2000 microEFM is installed in a fieldbus network, the device must be configured using ModWorX Pro software or the front keypad. Additionally, the device must be configured to communicate within the fieldbus network.

Configuration for Modbus Communications

Basic parameters such as communications port slave address and baud rate, date and time, contract hour, and plate size can be configured from the device keypad. All other parameters must be configured using the ModWorX Pro software provided with the purchase of a Scanner 2000.

ModWorX™ Pro allows users to calibrate and configure the Scanner 2000 microEFM for Modbus communications and download log archives in an easy-to-read report. Up to 16 user-selectable parameters can be logged and downloaded using ModWorX™ Pro software.

The Scanner 2000 microEFM saves up to 2304 interval logs (interval periods are adjustable from 5 sec to 12 hours), 768 daily logs, and 1152 event/alarm logs in nonvolatile memory. The download files are stored in an uneditable format on the user's CPU, and can be viewed immediately or exported to an alternative format (.csv, .xls, .rtf, html, or Flow-Cal®).

Event logs track user changes to flow parameters that impact log data. Such changes may include orifice plate changes, K-factor changes, input setting changes, and device events like over-range and resets.

Configuration for Fieldbus Communications

FOUNDATION™ fieldbus configuration is performed with a customer-supplied configuration tool. For basic instructions for configuring the function blocks that are integral to the Scanner 2000, see [Section 5—Fieldbus Configuration and Operation, page 63](#).

Specifications

Table 1.1—Scanner 2000 microEFM Specifications



Electrical Safety Classification	Approved by SIRA to ATEX 10ATEX2242  II 2G  Ex ia IIB T4 Gb IP66 (-40°C to +78°C)
Pressure Classification	ASME pressure vessel code compliant, 0 to 3000 psi (CRN 0F10472.5C)
Enclosure	Cast aluminum, painted with epoxy and polyurethane
Weight	11.2 lb (5.08 kg), approximate
System Power	Internal power supply <ul style="list-style-type: none"> • Battery pack, 2 “D” batteries in series, 7.2V, lithium • FISCO-certified power supply • Connects to fieldbus interface board (TB4) • Safety ratings: Ui = 17.5 V, li = 380 mA, Ci = 0, Li = 10 µH • Device current consumption: 26 mA
Operating Temperature	-40°C to 78°C (-40°F to 172°F) LCD contrast is reduced below -30°C (-22°F)
 WARNING: EXPLOSION RISK. Housing temperature must not exceed 70°C (158°F). Excessive temperatures, which could result from ambient conditions combined with radiated and conductive heat from the process, could cause the internal lithium battery to ignite or explode.	
LCD Display	8-digit top readout of values (7-segment characters) 6-digit bottom readout of scrolling parameters and associated engineering units (11-segment characters for easy-to-read prompts) View up to 12 user-defined parameters View daily log data User-selectable units of measurement 0.3” character height Configurable scan parameters and duration Adjustable contrast and update period
Keypad	3-key membrane switch Password-protected security available
Logging	Daily records: 768 (>2 years) Interval records: <ul style="list-style-type: none"> • Adjustable from 5 sec to 12 hours • 2304 (>3 months of 1-hour intervals) Event/alarm records: 1152

Table 1.1—Scanner 2000 microEFM Specifications

Logging (cont'd)	Records up to 16 user-defined parameters Logs stored in non-volatile memory for up to 10 years
Memory	Non-volatile memory for Modbus configuration and log data 256 KB
Modbus Communications/ Archive Retrieval	RS-485 Modbus communications port (300 to 38.4K baud) on main board RTU Modbus® and Enron Modbus® compliant downloads User-defineable Modbus® map with up to 25 floating point values Full download from main board in approximately 3 minutes Optional external communications adapter allows quick-connects to RS-485 Modbus COM port without removing the enclosure lid
Flow Rate Calculations	Natural Gas (Orifice/NuFlo Cone): AGA Report No. 3: Orifice Metering of Natural Gas and Other Related Hydrocarbon Fluids; ISO 5167: Measurement of Fluid Flow by Means of Pressure Differential Devices Inserted in Circular Cross-Section Conduits Running Full NuFlo Cone Meter User Manual, www.c-a-m.com (Measurement Systems Division page) Natural Gas (Turbine Meter): AGA Report No. 7: Measurement of Natural Gas by Turbine Meters Natural Gas (Averaging Pitot Tube Meter): ASME MFC-12M-2006: Measurement of Fluid Flow in Closed Conduits Using Multiport Averaging Pitot Primary Elements
Flow Rate Calculations	Steam (Orifice/NuFlo Cone): AGA Report No. 3: Orifice Metering of Natural Gas and Other Related Hydrocarbon Fluids; ISO 5167: Measurement of Fluid Flow by Means of Pressure Differential Devices Inserted in Circular Cross-Section Conduits Running Full NuFlo Cone Meter User Manual, www.c-a-m.com (Measurement Systems Division page) Liquids (Turbine): API Manual of Petroleum Measurement Standards, Chapter 5, Section 3, Measurement of Liquid Hydrocarbons by Turbine Meters Compensated Liquids (Orifice/NuFlo Cone/Turbine): AGA Report No. 3: Orifice Metering of Natural Gas and Other Related Hydrocarbon Fluids; ISO 5167: Measurement of Fluid Flow by Means of Pressure Differential Devices Inserted in Circular Cross-Section Conduits Running Full NuFlo Cone Meter User Manual, www.c-a-m.com (Measurement Systems Division page) AGA Report No. 7: Measurement of Natural Gas by Turbine Meters (as basis for liquid measurement)
Fluid Property Calculations	Natural Gas: AGA Report No. 8; "Compressibility Factors of Natural Gas and Other Related Hydrocarbon Gases"; Second Edition, AGA Catalogue XQ9212; American Gas Association, Arlington Virginia 1994. AGA Report No. 3, "Orifice Metering of Natural Gas and Other Hydrocarbon Fluids," Part 3, "Natural Gas Applications," Third Edition, 1992, Appendix F, Heating Value Calculation."

Table 1.1—Scanner 2000 microEFM Specifications

<p>Fluid Property Calculations (cont'd)</p>	<p>Natural Gas: GPA 2145-09, "Table of Physical Properties for Hydrocarbons and Other Compounds of Interest to the Natural Gas Industry," Gas Processors Association, Tulsa Oklahoma, 2008. Steam: IAPWS Industrial-Formulation 1997 (IF-97) Wet Correction Methods: James and Chisholm (Orifice); Steven (NuFlo Cone) Liquids: Generic (based on user-defined constants for density and viscosity) API-2540 - 1980, Petroleum Measurement Tables</p>																																																																																				
<p>MVT</p>	<p>Provides linearized static pressure and differential pressure Available with bottom ports or side ports NACE-compliant units also available (See Table 2.1, page 21 for bolt specifications.) Process temperature: -40°C to 121°C (-40°F to 250°F) User-adjustable sample time and damping See Temperature Warning in Operating Temperature section of this table (page 11).</p>																																																																																				
<p>MVT Accuracy</p>	<p>Stability: Long-term drift is less than ±0.05% of upper range limit (URL) per year over a 5-year period Differential Pressure Accuracy (30 In. H2O) <ul style="list-style-type: none"> ±0.1% of full scale ±0.50% of full scale over operating temperatures -30°C to 78°C Differential Pressure Accuracy (200 to 840 In. H2O) <ul style="list-style-type: none"> ±0.05% of full scale ±0.25% of full scale over operating temperatures -30°C to 78°C Effect on differential pressure for a 100-psi change in static pressure:</p> <table border="1" data-bbox="565 1136 1464 1850"> <thead> <tr> <th>SP/SWP (PSIA)</th> <th>DP (IN H2O)</th> <th>Max. Overrange (PSIA)</th> <th>Zero Shift</th> <th>Span Shift</th> </tr> </thead> <tbody> <tr> <td>100</td> <td>30</td> <td>150</td> <td>±0.05% of URL</td> <td>±0.01% of reading</td> </tr> <tr> <td>300</td> <td>200</td> <td rowspan="2">450</td> <td>±0.007% of URL</td> <td>±0.01% of reading</td> </tr> <tr> <td>300</td> <td>840</td> <td>±0.002% of URL</td> <td>±0.01% of reading</td> </tr> <tr> <td>500</td> <td>200</td> <td>750</td> <td>±0.010% of URL</td> <td>±0.01% of reading</td> </tr> <tr> <td>1500</td> <td>200</td> <td rowspan="4">2250</td> <td>±0.010% of URL</td> <td>±0.01% of reading</td> </tr> <tr> <td>1500</td> <td>300</td> <td>±0.004% of URL</td> <td>±0.01% of reading</td> </tr> <tr> <td>1500</td> <td>400</td> <td>±0.004% of URL</td> <td>±0.01% of reading</td> </tr> <tr> <td>1500</td> <td>840</td> <td>±0.004% of URL</td> <td>±0.01% of reading</td> </tr> <tr> <td>3000</td> <td>200</td> <td rowspan="4">4500</td> <td>±0.010% of URL</td> <td>±0.01% of reading</td> </tr> <tr> <td>3000</td> <td>300</td> <td>±0.004% of URL</td> <td>±0.01% of reading</td> </tr> <tr> <td>3000</td> <td>400</td> <td>±0.004% of URL</td> <td>±0.01% of reading</td> </tr> <tr> <td>3000</td> <td>840</td> <td>±0.004% of URL</td> <td>±0.01% of reading</td> </tr> <tr> <td>5300</td> <td>200</td> <td rowspan="4">7420</td> <td>±0.010% of URL</td> <td>±0.01% of reading</td> </tr> <tr> <td>5300</td> <td>300</td> <td>±0.004% of URL</td> <td>±0.01% of reading</td> </tr> <tr> <td>5300</td> <td>400</td> <td>±0.004% of URL</td> <td>±0.01% of reading</td> </tr> <tr> <td>5300</td> <td>840</td> <td>±0.004% of URL</td> <td>±0.01% of reading</td> </tr> <tr> <td>5800</td> <td>200</td> <td rowspan="2">8120</td> <td>±0.010% of URL</td> <td>±0.01% of reading</td> </tr> <tr> <td>5800</td> <td>400</td> <td>±0.004% of URL</td> <td>±0.01% of reading</td> </tr> </tbody> </table>	SP/SWP (PSIA)	DP (IN H2O)	Max. Overrange (PSIA)	Zero Shift	Span Shift	100	30	150	±0.05% of URL	±0.01% of reading	300	200	450	±0.007% of URL	±0.01% of reading	300	840	±0.002% of URL	±0.01% of reading	500	200	750	±0.010% of URL	±0.01% of reading	1500	200	2250	±0.010% of URL	±0.01% of reading	1500	300	±0.004% of URL	±0.01% of reading	1500	400	±0.004% of URL	±0.01% of reading	1500	840	±0.004% of URL	±0.01% of reading	3000	200	4500	±0.010% of URL	±0.01% of reading	3000	300	±0.004% of URL	±0.01% of reading	3000	400	±0.004% of URL	±0.01% of reading	3000	840	±0.004% of URL	±0.01% of reading	5300	200	7420	±0.010% of URL	±0.01% of reading	5300	300	±0.004% of URL	±0.01% of reading	5300	400	±0.004% of URL	±0.01% of reading	5300	840	±0.004% of URL	±0.01% of reading	5800	200	8120	±0.010% of URL	±0.01% of reading	5800	400	±0.004% of URL	±0.01% of reading
SP/SWP (PSIA)	DP (IN H2O)	Max. Overrange (PSIA)	Zero Shift	Span Shift																																																																																	
100	30	150	±0.05% of URL	±0.01% of reading																																																																																	
300	200	450	±0.007% of URL	±0.01% of reading																																																																																	
300	840		±0.002% of URL	±0.01% of reading																																																																																	
500	200	750	±0.010% of URL	±0.01% of reading																																																																																	
1500	200	2250	±0.010% of URL	±0.01% of reading																																																																																	
1500	300		±0.004% of URL	±0.01% of reading																																																																																	
1500	400		±0.004% of URL	±0.01% of reading																																																																																	
1500	840		±0.004% of URL	±0.01% of reading																																																																																	
3000	200	4500	±0.010% of URL	±0.01% of reading																																																																																	
3000	300		±0.004% of URL	±0.01% of reading																																																																																	
3000	400		±0.004% of URL	±0.01% of reading																																																																																	
3000	840		±0.004% of URL	±0.01% of reading																																																																																	
5300	200	7420	±0.010% of URL	±0.01% of reading																																																																																	
5300	300		±0.004% of URL	±0.01% of reading																																																																																	
5300	400		±0.004% of URL	±0.01% of reading																																																																																	
5300	840		±0.004% of URL	±0.01% of reading																																																																																	
5800	200	8120	±0.010% of URL	±0.01% of reading																																																																																	
5800	400		±0.004% of URL	±0.01% of reading																																																																																	

Table 1.1—Scanner 2000 microEFM Specifications

<p>MVT Accuracy (cont'd)</p>	<p>Static Pressure Accuracy (300, 500, 1500, and 3000 psia)</p> <ul style="list-style-type: none"> • ±0.05% of full scale • ±0.25% of full scale over operating temperatures -30°C to 78°C <p>Static Pressure Accuracy (5300 and 5800 psia)</p> <ul style="list-style-type: none"> • ±0.05% of full scale • ±0.50% of full scale over operating temperatures -30°C to 78°C 																								
<p>Modbus Inputs (Main Board)</p>	<p>Turbine Meter Input 1 (TB1)</p> <ul style="list-style-type: none"> • Configurable sensitivity adjustment (20, 50, 100 or 200 mV, peak-to-peak) • Frequency range: 0 to 3500 Hz • Input amplitude: 20 mV to 3000 mV, peak to peak <table border="1" data-bbox="565 575 1421 806"> <thead> <tr> <th data-bbox="565 575 781 611">Turbine Setting</th> <th colspan="3" data-bbox="787 575 1421 611">Input Sensitivity</th> </tr> <tr> <td data-bbox="565 619 781 655"></td> <td data-bbox="787 619 997 655">0 – 1000 Hz</td> <td data-bbox="1003 619 1213 655">1000 – 2000 Hz</td> <td data-bbox="1219 619 1421 655">2000 – 3500 Hz</td> </tr> </thead> <tbody> <tr> <td data-bbox="565 663 781 699">Low (20mV)</td> <td data-bbox="787 663 997 699">20 mVpp</td> <td data-bbox="1003 663 1213 699">25 mVpp</td> <td data-bbox="1219 663 1421 699">50 mVpp</td> </tr> <tr> <td data-bbox="565 707 781 743">Med (50mV)</td> <td data-bbox="787 707 997 743">50 mVpp</td> <td data-bbox="1003 707 1213 743">70 mVpp</td> <td data-bbox="1219 707 1421 743">110 mVpp</td> </tr> <tr> <td data-bbox="565 751 781 787">High (100mV)</td> <td data-bbox="787 751 997 787">100 mVpp</td> <td data-bbox="1003 751 1213 787">150 mVpp</td> <td data-bbox="1219 751 1421 787">250 mVpp</td> </tr> <tr> <td data-bbox="565 795 781 831">Max (200mV)</td> <td data-bbox="787 795 997 831">200 mVpp</td> <td data-bbox="1003 795 1213 831">380 mVpp</td> <td data-bbox="1219 795 1421 831">620 mVpp</td> </tr> </tbody> </table> <ul style="list-style-type: none"> • Use only with ATEX-approved IS-rated pickups For NuFlo turbine meters, use part no. 9A-99145007 or 9A-99145008 For Barton 7000 meters, use part no. 9A-2113-001A-01 or 9A-2113-001A-02 (see Spare Parts list, page 81, for descriptions). <p>Process Temperature Input (TB1)</p> <ul style="list-style-type: none"> • 100-ohm platinum RTD with 2-wire, 3-wire, or 4-wire interface • Sensing Range: -40°C to 427°C (-40°F to 800°F) • Accuracy: 0.2°C (0.36°F) over sensing range at calibrated temperature • Temperature effect: 0.3°C over operating range of -40°C to 78°C (0.54°F over operating range of -40°F to 172°F) • Resolution: 24 bits • User-adjustable sample time and damping • Safety ratings: Uo = 8.1 V, Io = 0.272 A, Po = 0.465 W • Maximum cable length: 30 m/100 ft <p>Communications Input (TB2)</p> <ul style="list-style-type: none"> • RS-485 communications port (300 to 38.4K baud) • Accessed via external communications connector 	Turbine Setting	Input Sensitivity				0 – 1000 Hz	1000 – 2000 Hz	2000 – 3500 Hz	Low (20mV)	20 mVpp	25 mVpp	50 mVpp	Med (50mV)	50 mVpp	70 mVpp	110 mVpp	High (100mV)	100 mVpp	150 mVpp	250 mVpp	Max (200mV)	200 mVpp	380 mVpp	620 mVpp
Turbine Setting	Input Sensitivity																								
	0 – 1000 Hz	1000 – 2000 Hz	2000 – 3500 Hz																						
Low (20mV)	20 mVpp	25 mVpp	50 mVpp																						
Med (50mV)	50 mVpp	70 mVpp	110 mVpp																						
High (100mV)	100 mVpp	150 mVpp	250 mVpp																						
Max (200mV)	200 mVpp	380 mVpp	620 mVpp																						
<p>Modbus Output (Main Board)</p>	<p>Digital Output (TB3)</p> <ul style="list-style-type: none"> • Configurable as pulse output or alarm output • Solid-state relay • Output rating: 60 mA max @ 30 VDC • No Modbus to fieldbus conversion supported <p>When configured as pulse output:</p> <ul style="list-style-type: none"> • Maximum frequency: 50 Hz • Configurable pulse duration (65,535 msec max) • Configurable pulse representation (1 pulse = 1 MCF) • Based on any accumulator (flow run or turbine meter run) <p>When configured as alarm output:</p> <ul style="list-style-type: none"> • Low/high • Out-of-range • Status/diagnostic • Latched/unlatched 																								

Table 1.1—Scanner 2000 microEFM Specifications

Modbus Output (Main Board, cont'd)	When configured as alarm output (cont'd): <ul style="list-style-type: none"> • Normally open/normally closed • Safety ratings: Uo = 0, Ui = 30 Vdc, li = 60 mA
FOUNDATION™ Fieldbus	Fieldbus power/communications port on fieldbus interface board (TB4) Fieldbus module contains 1 resource block, 1 transducer block, and 4 analog input blocks Device is capable of being a link master and a link active scheduler
Modbus Interface Software	<p>Provided at no charge Easy to use Real-time data polling Complete configuration Configuration upload for configuring multiple units Multi-level security Field calibration</p> <ul style="list-style-type: none"> • 1 to 12 calibration points for each parameter • Three methods: multi-point, set zero point, and verify (API compliant) • Inputs are automatically locked during calibration <p>Maintenance</p> <ul style="list-style-type: none"> • Change plate • Change cone (linearization: 1 to 12 points) • Change gas composition • Change steam properties • Change flow coefficients • Change K-factor (linearization: 1 to 12 points) • Change turbine flowmeter • Change generic/API liquid parameters <p>Archive data downloads</p> <ul style="list-style-type: none"> • Configurable downloads of “all” or “new” records • Download types: daily, interval, and event/alarm records • Downloads are automatically saved in uneditable binary (SDF) files • Exports to .xls, .csv, .rtf, .html, and Flow-Cal® formats <p>Reporting</p> <ul style="list-style-type: none"> • Daily logs (table or trend graph) • Interval logs (table or trend graph) • Event/alarm logs • Configuration settings • Calibration settings • Snapshot of current status data and calculated parameters
System Requirements	<p>Operating System - Windows 2000 or later (Windows XP recommended) Computer/Processor - 1 GHz or faster Pentium-compatible CPU Memory - 128 MB of RAM Hard Disk Space - 100 MB for program files, 30 MB for Adobe Reader, adequate space for data files Drive - CD-ROM for install Display - 1024 x 768, 16-bit color display or greater Browser - Internet Explorer 6 or later Internet Connection - for web links, tech support Communications Port - physical or virtual RS-232 compatible serial port</p>

Flow Rate and Fluid Property Calculations

The Scanner 2000 calculates flow rates and fluid properties for natural gas, steam and liquid flow. The following descriptions identify the industry standards upon which these calculations are based.

Natural Gas

The Scanner 2000's natural gas calculations and data storage conform to AGA-3, AGA-7, AGA-8, API 21.1, and ISO-5167 industry standards. The flow calculations compensate for the effects of pressure, temperature, and gas composition to calculate the volume of gas measured at specified base conditions. These calculations typically require configuration of inputs including differential pressure, static pressure, process temperature, and for AGA-7, a turbine meter input.

The integral multi-variable transmitter (MVT) is used to measure static pressure and differential pressure. A 4-wire, 100-ohm platinum RTD is recommended for measuring process temperature. Where temperature is relatively constant, a fixed temperature value may be configured.

Orifice Plate (DP Input). The Scanner 2000 calculates natural gas flow rate from orifice plates using calculation methods found in the AGA-3 or ISO-5167 measurement standards. The natural gas fluid properties, such as density and compressibility, are calculated in accordance with AGA-8 (Detail and Gross methods). Heating values are calculated in accordance with AGA Report 3, Part 3, Appendix F using the gas properties defined in GPA 2145. Molar mass (molecular weight) calculations are also based on GPA 2145.

NuFlo Cone Meter (DP Input). The Scanner 2000 calculates natural gas flow rate from cone meters using industry-recognized algorithms identified in the NuFlo Cone Meter User Manual. The natural gas fluid properties, such as density and compressibility, are calculated in accordance with AGA-8 (Detail and Gross methods). Heating values are calculated in accordance with AGA Report 3, Part 3, Appendix F using the gas properties defined in GPA 2145. Molar mass (molecular weight) calculations are also based on GPA 2145.

Gas Turbine Meter (Frequency Input). The Scanner 2000 calculates natural gas flow rate from a gas turbine meter using calculations found in the AGA-7 measurement standard. The natural gas fluid properties, such as density and compressibility, are calculated in accordance with AGA-8 (Detail and Gross methods). Heating values are calculated in accordance with AGA Report 3, Part 3, Appendix F using the gas properties defined in GPA 2145. Molar mass (molecular weight) calculations are also based on GPA 2145.

Averaging Pitot Tube Meter (Annubar®). The Scanner 2000 calculates natural gas flow rate from an averaging pitot tube meter using calculations found in the ASME MFC-12M-2006 measurement standard. The natural gas fluid properties, such as density and compressibility, are calculated in accordance with AGA-8 (Detail and Gross methods). Heating values are calculated in accordance with AGA Report 3, Part 3, Appendix F using the gas properties defined in GPA 2145. Molar mass (molecular weight) calculations are also based on GPA 2145.

Steam

The Scanner 2000's saturated steam calculations compensate for the effects of pressure, temperature, steam properties, and steam quality.

Orifice Plate (DP Input). The Scanner 2000 supports steam measurement based on AGA-3 or ISO-5167 flow rate methods for orifice plates. Fluid properties are calculated in accordance with the IAPWS Industrial-Formulation 1997 (IF-97) standard. Temperature is calculated according to IF-97 for saturated steam, based on static pressure. Therefore, an RTD is not required. The optional Chisholm and James wet correction methods are supported for the measurement of vapor and fluid.

NuFlo Cone Meter (DP Input). The Scanner 2000 supports steam measurement using industry-recognized algorithms identified in the NuFlo Cone Meter User Manual. Fluid properties for steam are calculated in accordance with the IAPWS Industrial-Formulation 1997 (IF-97) standard. Temperature is calculated according to IF-97 for saturated steam, based on static pressure. Therefore, an RTD is not required. The optional Steven wet correction method is supported for the measurement of vapor and fluid.

Averaging Pitot Tube Meter (Annubar®). The Scanner 2000 supports steam measurement based on ASME MFC-12M -2006 flow rate methods for averaging pitot tube meters. Fluid properties are calculated in accordance with the IAPWS Industrial-Formulation 1997 (IF-97) standard. Temperature is calculated according to IF-97 for saturated steam, based on static pressure. Therefore, an RTD is not required. Wet correction methods are not supported.

Compensated Liquid

The Scanner 2000 measures compensated petroleum liquid flow using an orifice, cone, liquid turbine, or averaging pitot tube (Annubar®) flowmeter. Users can select either of two fluid property calculation methods for use with any of these flowmeters.

- The “generic” fluid properties calculation method is used to measure liquids such as water or emulsions, based on user-supplied viscosity values and either user-supplied density values or user-supplied liquid thermal expansion coefficients.
- The API-2540 calculation method provides temperature corrections for the following petroleum liquids: crude oil, gasoline, jet fuel, fuel oils, and lube oil.

Orifice Plate (DP Input). The Scanner 2000 calculates flow rates in accordance with AGA Report No. 3, Part 1 (1990) or ISO-5167 (2003) methods. When measuring liquids, the expansion factor (Y) is always equal to 1.0. Fluid property calculations for temperature-compensated measurements are based on API-2540 (1980), Petroleum Measurement Tables.

NuFlo Cone Meter (DP Input). The Scanner 2000 calculates flow rates in accordance with industry-recognized algorithms identified in the NuFlo Cone Meter User Manual. When measuring liquids, the expansion factor (Y) is always equal to 1.0. Fluid property calculations for temperature-compensated liquids are based on API-2540 (1980), Petroleum Measurement Tables.

Liquid Turbine Meter (Frequency Input). The Scanner 2000 calculates flow rates in accordance with the measurement principles upon which the AGA-7 standard is based. The user supplies a linear or multi-point calibration factor, and the instrument performs the required compensation calculations, based on the RTD input.

Averaging Pitot Tube Meter (Annubar®). The Scanner 2000 calculates flow rates in accordance with the ASME MFC-12M-2006 measurement standard. When measuring liquids, the expansion factor (Y) is always equal to 1.0. Fluid property calculations for temperature-compensated liquids are based on API-2540 (1980), Petroleum Measurement Tables.

Uncompensated Liquid

The Scanner 2000 measures uncompensated liquid flow based on the input from a liquid turbine meter or PD meter.

Liquid Turbine Meter (Frequency Input) or PD Meter (Pulse Input). The Scanner 2000 calculates flow rate from a liquid turbine meter via a frequency input. Flow rates and totals are calculated using a user-supplied linear or multi-point calibration factor in accordance with API Manual of Petroleum Measurement Standards, Chapter 5, Section 3, Measurement of Liquid Hydrocarbons by Turbine Meters (2005).

Section 2—Installing the Scanner 2000

Overview

The Scanner 2000 FISCO-certified field device is safe for use in FISCO intrinsically safe installations when installed in accordance with EN 60079-11:2007, and EN 60079-27:2008.

The following customer-supplied equipment is recommended for installation in a fieldbus network:

- host computer
- FISCO-certified power supply
- FISCO-certified linking device (may be combined with the host system)
- FISCO-certified terminators
- Type A single pair shielded twisted cable for the power connection

The Scanner 2000 has the capability to be a link master and a link active scheduler for controlling communication on the bus.

Control System Components

In its simplest form, a FOUNDATION™ fieldbus control system has two tiers: a host network and a field network. The instruments that make up the field network connect to the host level workstations via a linking device. The field network consists of one or more segments, with a terminator at each end. Field devices receive their power and their ability to communicate with other devices and the host from the fieldbus network. Up to 32 devices can be connected to a single network.

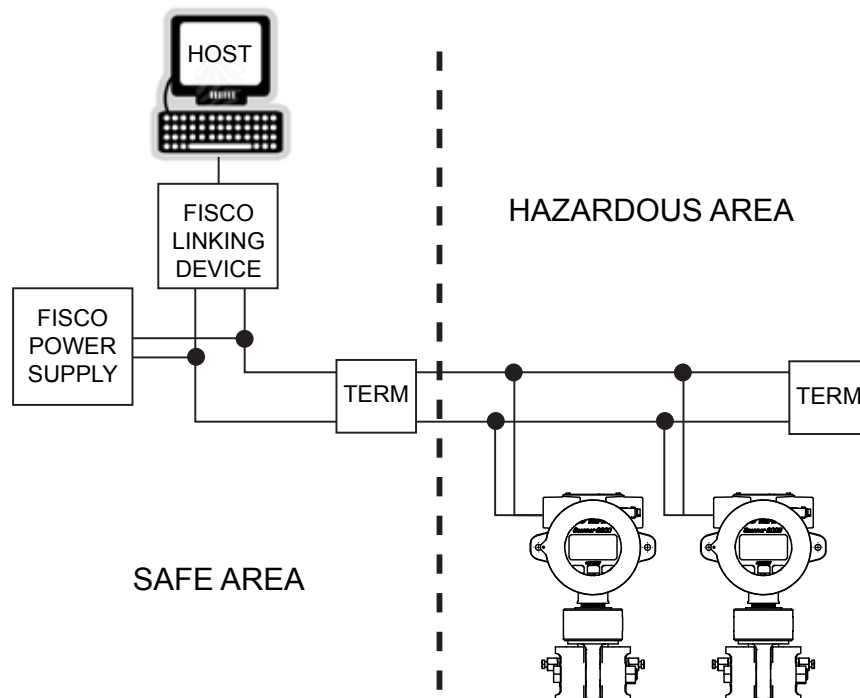

Figure 2.1—Basic FISCO installation

Hazardous Area Installations

The ATEX-certified standard Scanner 2000 microEFM for FOUNDATION™ Fieldbus is fully compliant with European ATEX Directive 94/9/EC, and has been assessed against the equivalent IEC standards to the following EN standards: EN 60079-0:2006, EN 60079-0:2009, EN 60079-11:2007, and EN 60079-27:2008.

The following instructions apply to equipment covered by certificate number Sira 10ATEX2242:

- The equipment may be used in zones 1 and 2 with flammable gases and vapours. It is not certified for use in flammable dusts.
- The equipment may be used in the presence of flammable gases and vapours with apparatus groups IIB or IIA and with temperature classes T1, T2, T3, or T4.
- The equipment is certified for use in ambient temperatures in the range of -40°C to $+78^{\circ}\text{C}$ and should not be used outside this range.
- The equipment is to be installed by suitably trained personnel in accordance with the applicable code of practice (typically IEC/EN 60079-14)
- Regular periodic inspection of the equipment should be performed by suitably trained personnel in accordance with the applicable code of practice (e.g. IEC/EN 60079-17) to ensure it is maintained in a satisfactory condition.
- Subject to the applicable code of practice, and with appropriate measures to prevent damage, the enclosure may be temporarily opened and the internal battery pack replaced while the equipment is in a hazardous area. Only intrinsically safe battery pack part number 9A-30099008 shall be used.



WARNING: A laptop is typically used for configuring the Scanner 2000 microEFM. Connect a laptop to the device only when the area is known to be non-hazardous.

Wiring Considerations in Hazardous Areas

CAUTION In accordance with EN60079-0, Clause 16.5, all cable and cable glands must be rated for 80°C .

Pressure Safety Precautions



WARNING: Before connecting the Scanner 2000 microEFM to a flow line, consider the pressure rating of the sensor, and the presence of harmful gases. The tubing and fixtures used to connect the sensor to the manifold in the flow line must be manufactured from materials that are appropriate for the pressure ratings of the sensor used.



WARNING: If H₂S is present, use a NACE sensor and take appropriate precautions to avoid exposure to this hazardous gas.

Table 2.1—MVT Pressure Limits, Approvals and Bolt Specifications

SP/SWP (PSIA)	DP (IN H2O)	Max. Overrange (PSIA)	ASME Pressure Vessel Code Compliant	Standard Bolts	NACE Bolts
100	30	150	X	B7 or 316 SS	B7M
300	200	450	X	B7 or 316 SS	B7M
300	840				
500	200	750	X	B7 or 316 SS	B7M
1500	200	2250	X	B7 or 316 SS	B7M
1500	300				
1500	400				
1500	840				
3000	200	4500	X	B7 or 17-4 SS	Inconel
3000	300				
3000	400				
3000	840				
5300	200	7420	—	B7	Inconel
5300	300				
5300	400				
5300	840				
5800	200	8120	—	17-4 SS	Contact factory
5800	400				

Mounting Options

The standard Scanner 2000 microEFM is fully assembled at the time of shipment and ready for mounting. If the Scanner is ordered with a terminal housing, install the cable glands supplied with the shipment before mounting the instrument.

The Scanner 2000 microEFM can be mounted using the following methods:

- Direct-mount to an orifice or cone type DP meter. The integral multi-variable sensor may be connected to the pressure taps with stabilizers or a heavy wall nipple with adapter flanges, and a 5-valve manifold. A bottom-port MVT is recommended for gas measurement; a side-mount MVT is recommended for liquid or steam measurement.
- Direct-mount to a turbine meter. The instrument can be mounted to a turbine meter using a pipe adapter and union connection ([Figure 2.3, page 22](#)).
- Pole-mount option. The instrument can be mounted on a 2-in. pole using a NuFlo hardware kit, or bulk-head-mounted to a flat, vertical surface (see [Pole-Mounting Kit, page A-3](#). Pole mounting may be preferred where limited space or pipe vibration prohibits direct-mount installation. A horizontal pipe mount is recommended for liquid and steam installations using a side-port MVT and block manifold. Tubing is used to connect the integral MVT to the orifice meter or cone meter. If a Scanner 2000 will be used for steam measurement, a condensate pot must also be installed to protect the Scanner 2000 from extreme temperatures. See [Measuring Steam via a Differential Pressure Meter, page 29](#), for details.

The following accessories are also recommended:

- a 5-valve manifold for connecting process lines to the integral MVT
- an RTD assembly for process temperature input on gas flow runs and compensated liquid flow runs (not recommended for steam flow runs)
- tubing and/or pipe for plumbing process connections
- signal cable for remote turbine connections (stranded, shielded cable is recommended)
- terminal housing (if external communications adapter and RTD are used)

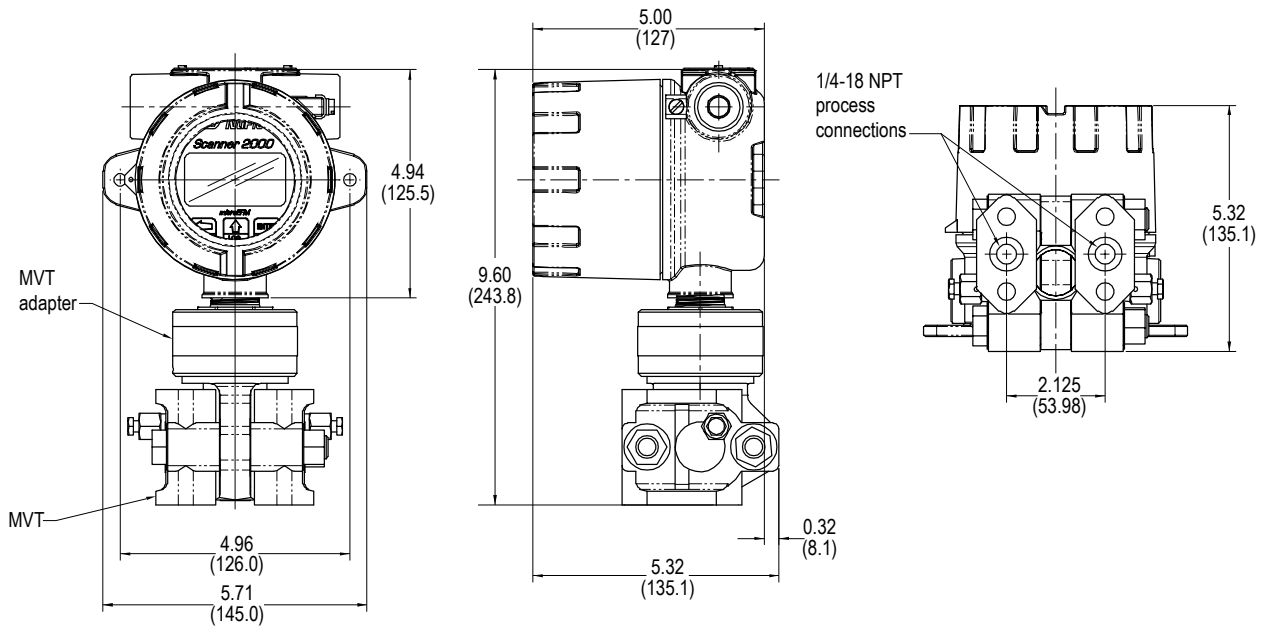

Figure 2.2—Scanner 2000 with direct-mount MVT (MVT with bottom ports shown)

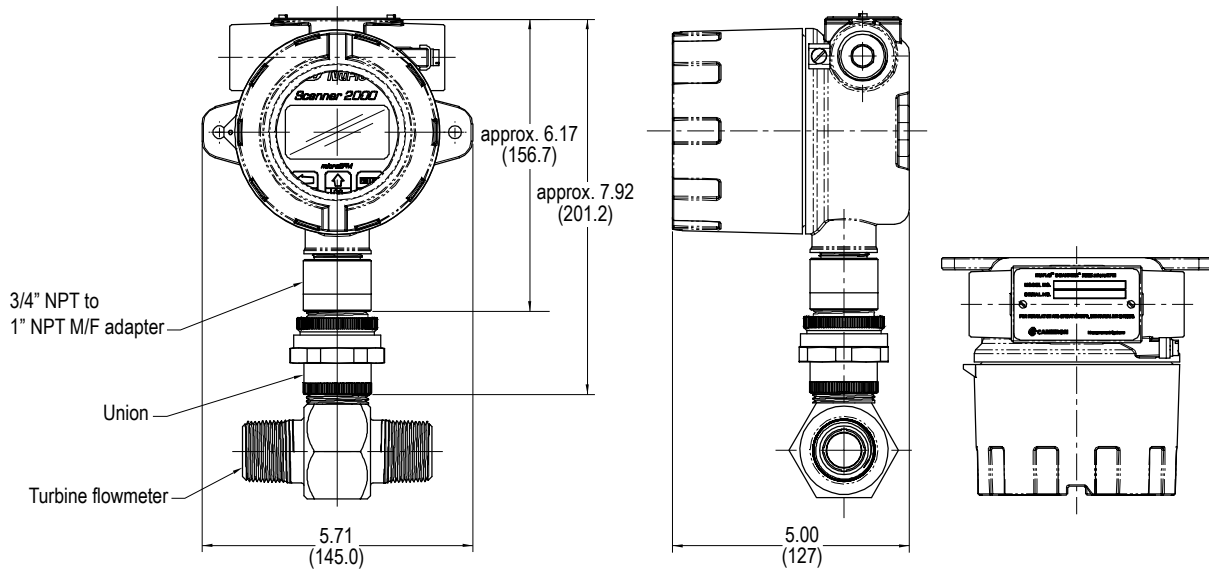

Figure 2.3—Scanner 2000 direct-mounted to a NuFlo turbine flowmeter (union and adapter are also suitable for mounting a Barton 7000 Series meter)

Measuring Natural Gas via a Differential Pressure Meter

Note This section contains installation guidelines for orifice and cone meters. If installing the Scanner 2000 with an averaging pitot tube meter, refer to manufacturer instructions for installation.

Best Practices for Orifice and Cone Meter Installation

To ensure measurement accuracy, ensure that the meter run complies with the following AGA-3 and ISO 5167 guidelines, as applicable:

- Do not place unit near vents or bleed holes that discharge corrosive vapors or gases.
- Consider the orientation of the meter run when determining the best position for mounting the Scanner 2000.
 - If the Scanner 2000 is mounted to a horizontal pipeline, make sure process connections are at the top of the line, and mount the Scanner 2000 above the pressure connections at the pipe.
 - If the Scanner 2000 is mounted to a vertical pipeline, install the sensor above the differential pressure source connections, or install a condensate (drip) pot to prevent the accumulation of liquid in inter-connecting tubes. Slope all tubing upward at least 1-inch/linear foot to avoid liquid entrapment.
- Mount the Scanner 2000 as near level as possible such that the operator has a clear view of the LCD, and can access the keypad easily when the enclosure cover is removed. The location should be as free from vibration as possible.
- Make sure the high port of the sensor (marked “H”) is connected to the upstream side of the meter run.
- Flow should remain subsonic throughout the measuring section and should be single phase.
- Pipe diameters (D) should be between 2 in. (50 mm) and 39 in. (1000 mm) per ISO 5167; or greater than 2 in. (50 mm) per AGA-3.
- Pipe Reynolds numbers must be above 5000.
- d (orifice diameter) must be greater than or equal to 0.45 in. (11.5 mm).
- β (diameter ratio) must be greater than or equal to 0.1 and less than or equal to 0.75.
- Gauge lines should be of uniform internal diameter and constructed of material compatible with the fluid being measured. For most applications, the bore should be no smaller than ¼ in. (6 mm) and preferably, 3/8 in. (10 mm) in diameter. The internal diameter should not exceed 1 in. (25 mm). If high-temperature fluids are likely to be encountered, make sure the measuring tube used is rated for the anticipated temperature range. See also the warning in the Operating Temperature section of the Specifications Table (page 11).
- Gauge line length should be minimized to help prevent pulsation-induced errors.
- Gauge lines should slope downward to the meter at a minimum of one inch per foot.
- If gauge lines must slope in more than one direction, do not allow more than one bend and install a liquid or gas trap, as applicable. A liquid trap should be installed at the lowest point in a gas service installation.
- Gauge lines should be supported to prevent sag and vibration.
- Where pulsation is anticipated, full-port manifold valves with a nominal internal diameter consistent with the gauge lines are recommended.

If the Scanner 2000 is mounted to a cone meter, consider the following best practices in addition to the best practices listed above.

- Position the cone meter so that there are zero to five pipe diameters upstream of the meter and zero to three pipe diameters downstream of the meter.

- Install the meter so that the static pressure tap is upstream of the differential pressure tap. The high side of the integral Scanner 2000 sensor must also be situated upstream.
- Install shut-off valves directly on the DP meter pressure taps. Choose a shut-off valve that is rated for the ambient temperatures of the location and the operating pressure of the pipe in which it will be installed, and for use with dangerous or corrosive fluids or gases, if applicable. The valves must not affect the transmission of the differential pressure signal.

Installation Procedure—Direct Mount to Orifice Meter or Cone Meter

A Scanner 2000 can be mounted directly to an orifice meter or cone meter for gas measurement. The setup of the meter run and plumbing configurations can vary widely, depending upon the challenges existing on location. Figure 2.4 shows a typical direct-mount installation.

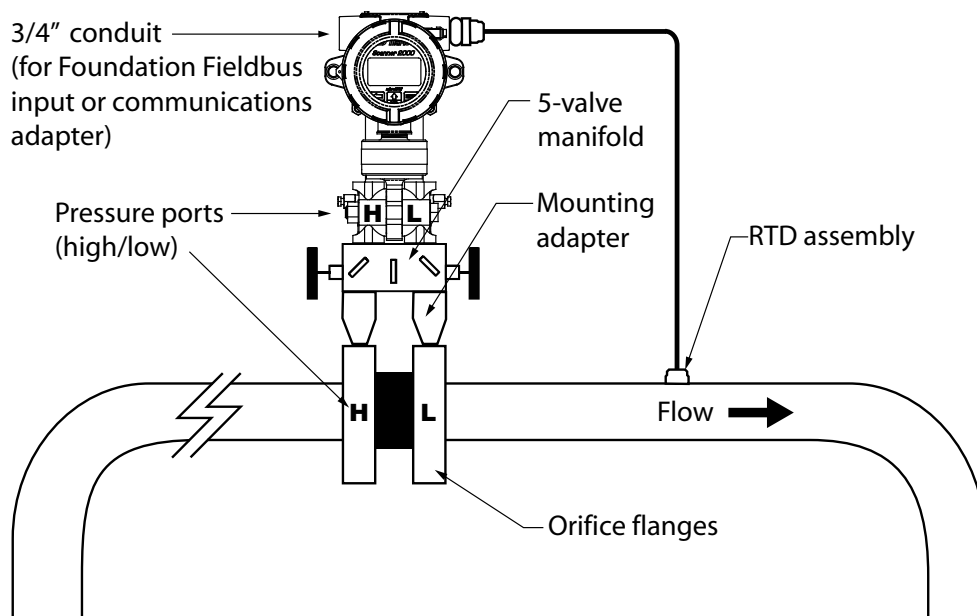

Figure 2.4—Direct-mount installation in an orifice meter run (shown here with an orifice meter). The direct-mount method can be used with a cone meter as well.

1. Verify that the meter is properly installed in the flow line (per manufacturer's instructions).
2. Bolt a flange-by-flange 5-valve manifold (as recommended by Cameron) to the Scanner 2000 MVT sensor.
 - a. Locate the H and L markings on the integral MVT sensor body and position the MVT/manifold assembly so that the upstream side of the flow line can easily be connected to the sensor's "High" port and the downstream side of the flow line can be connected to the sensor's "Low" port. The Scanner 2000 enclosure can be rotated to face the desired direction.
 - b. Position the manifold so that all valves are accessible from the front of the instrument.
3. Connect the Scanner 2000 and manifold assembly to the differential pressure meter. Hardware requirements will vary, depending upon the installation configuration. However, minimally, an adapter is required that can span between the threaded pressure tap/orifice flange connector and the non-threaded manifold. This adapter can be a one-piece stabilizer (often preferred for added strength and stability) or a short heavy wall pipe nipple attached to a football flange (available from Cameron). Use a suitable compound or tape on all threaded process connections.

4. Install the RTD assembly in the thermowell. Route the RTD assembly cable through the conduit opening in the top of the Scanner 2000 and connect it to the main circuit board. See [Figure 3.6, page 51](#), for wiring instructions.
5. Connect the lithium battery to the J1 connector on the main board.
6. Route the FOUNDATION™ fieldbus power cable through the second conduit opening in the top of the Scanner 2000 and connect to the fieldbus interface board. See [Figure 3.4, page 49](#), for wiring instructions.

Note If a terminal housing is used, FOUNDATION™ fieldbus power and RTD assembly cables may be routed through the terminal housing cable glands and connected to the terminal strip inside. Do not connect the fieldbus power cable without first connecting the lithium battery pack to the main board.

7. Perform a manifold leak test as described on page 39.
8. Verify the zero offset, if required (and other calibration points, if desired). See the ModWorX™ Pro Software User Manual, Part No. 9A-30165025, for complete instructions. See also [Zero Offset \(Static Pressure or Differential Pressure\), page 39](#), [Static Pressure Calibration and Verification, page 40](#), and [Differential Pressure Calibration and Verification, page 41](#).

CAUTION Do not put the Scanner into operation until the valves are positioned properly so that pressure is supplied to both sides of the MVT. For instructions on proper valve positions, see [Placing the Scanner into Operation, page 42](#).

Installation Procedure—Remote Mount to Orifice Meter or Cone Meter

A Scanner 2000 can be mounted remotely and connected to an orifice meter or cone meter with tubing for gas measurement. The setup of the meter run and plumbing configurations can vary widely, depending upon the challenges existing on location. [Figure 2.5, page 26](#) shows a typical remote-mount installation.

Note To prevent fittings from turning and/or to avoid putting tension on stainless steel tubing, use a backup wrench to attach stainless steel tubing to a manifold, shut-off valves, or sensor ports.

1. Verify that the meter is properly installed in the flow line (per manufacturer’s instructions).
2. Mount the Scanner 2000 to a 2-in. pipe or to a flat, vertical surface using bolts and the mounting holes in the enclosure.
3. Bolt a 5-valve flange-by-NPT manifold (as recommended by Cameron) to the Scanner 2000 MVT sensor.
 - a. Locate the H and L markings on the integral MVT sensor body and position the MVT/manifold assembly so that the upstream side of the flow line can easily be connected to the sensor’s “High” port and the downstream side of the flow line can be connected to the sensor’s “Low” port. The Scanner 2000 enclosure can be rotated to face the desired direction.
 - b. Position the manifold so that all valves are accessible from the front of the instrument.
4. Install tubing and fittings to connect the Scanner 2000 and manifold assembly to the differential pressure meter, sloping the gauge lines downward to the meter at a minimum of one inch per foot. Use a suitable compound or tape on all threaded process connections.

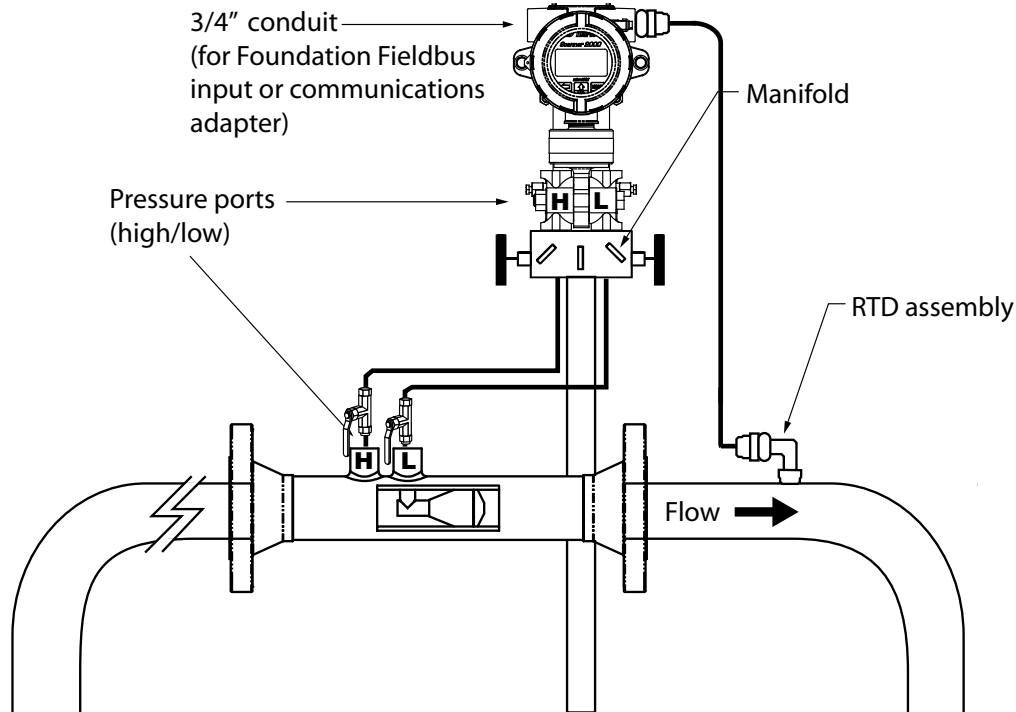

Figure 2.5—Remote-mount gas run installation (shown here with a cone meter). The remote-mount method can be used with an orifice meter as well.

5. Install the RTD assembly in the thermowell. Route the RTD assembly cable through the conduit opening in the top of the Scanner 2000 and connect it to the main circuit board. See [Figure 3.6, page 51](#), for wiring instructions.
6. Connect the lithium battery to the J1 connector on the main board.
7. Route the FOUNDATION™ fieldbus power cable through the second conduit opening in the top of the Scanner 2000 and connect to the fieldbus interface board. See [Figure 3.4, page 49](#), for wiring instructions.

Note If a terminal housing is used, FOUNDATION™ fieldbus power and RTD assembly cables may be routed through the terminal housing cable glands and connected to the terminal strip inside. Do not connect the fieldbus power cable without first connecting the lithium battery pack to the main board.

8. Perform a manifold leak test as described on page 39.
9. Verify the zero offset, if required (and other calibration points, if desired). See the ModWorX™ Pro Software User Manual, Part No. 9A-30165025, for complete instructions. See also [Zero Offset \(Static Pressure or Differential Pressure\), page 39](#), [Static Pressure Calibration and Verification, page 40](#), and [Differential Pressure Calibration and Verification, page 41](#).

CAUTION Do not put the Scanner into operation until the valves are positioned properly so that pressure is supplied to both sides of the MVT. For instructions on proper valve positions, see [Placing the Scanner into Operation, page 42](#).

Measuring Natural Gas via a Turbine Meter

Best Practices

The Scanner 2000 microEFM calculates gas flow through a turbine meter in accordance with AGA-7 and API 21.1 industry standards. For optimum performance, ensure that the turbine and Scanner 2000 installation complies with the industry recommendations listed below:

- Install the turbine flowmeter in the meter run such that there are 10 nominal pipe diameters upstream and five nominal pipe diameters downstream of the meter. Both inlet and outlet pipe should be of the same nominal size as the meter.
- Straightening vanes are recommended for eliminating swirl conditions. If used, they should be installed five pipe diameters upstream of the meter.
- Where an RTD is used to facilitate compensated gas measurement from a gas turbine meter, locate the RTD within five pipe diameters downstream of the meter outlet and upstream of any valve or flow restriction.

Installation Procedure—Remote Mount to a Turbine Meter

A Scanner 2000 can be mounted remotely and connected to a gas turbine meter for measuring gas in accordance with AGA-7 calculations. [Figure 2.6, page 28](#), shows an installation in which the pressure input is provided by the integral MVT.

Important Use only with ATEX-approved IS-rated pickups. For NuFlo turbine meters, use Part No. 9A-99145007 or 9A-99145008. For Barton 7000 meters, use Part No. 9A-2113-001A-01 or 9A-2113-001A-02. See Spare Parts list, page 81, for descriptions.

Since this type of installation requires a turbine input, a static pressure input, an RTD input, and a fieldbus power/communications input, a terminal housing is required. This procedure assumes that the turbine input is connected through a conduit opening in the top of the Scanner 2000, and that fieldbus power and RTD inputs are connected to the terminal housing terminal strip; however, terminal housing terminations are not limited to any specific inputs.

The setup of the meter run and plumbing configurations can vary widely, depending upon the challenges existing on location.

To connect the Scanner 2000 to a turbine meter, perform the following steps:

1. Verify that the flowmeter and magnetic pickup are installed in the flow line.
2. Mount the Scanner 2000 to a 2-in. pipe or to a flat, vertical surface using bolts and the mounting holes in the enclosure.
3. Bolt a 3-valve flange-by-NPT manifold (as recommended by Cameron) to the Scanner 2000 MVT sensor. Position the manifold so that all valves are accessible from the front of the instrument.
4. Connect the pressure port of the turbine meter to either manifold process port with tubing. The unused pressure port can be used as a “vent” as required. Always leave the equalizer valves open to allow pressure to both sides of the MVT. Use a suitable compound or tape on all threaded process connections.
5. Remove the plug from the conduit opening in the top of the Scanner 2000 enclosure, route the turbine signal cable through the opening, and connect it to the main circuit board. A wiring diagram for the turbine input is provided in [Figure 3.5, page 50](#).

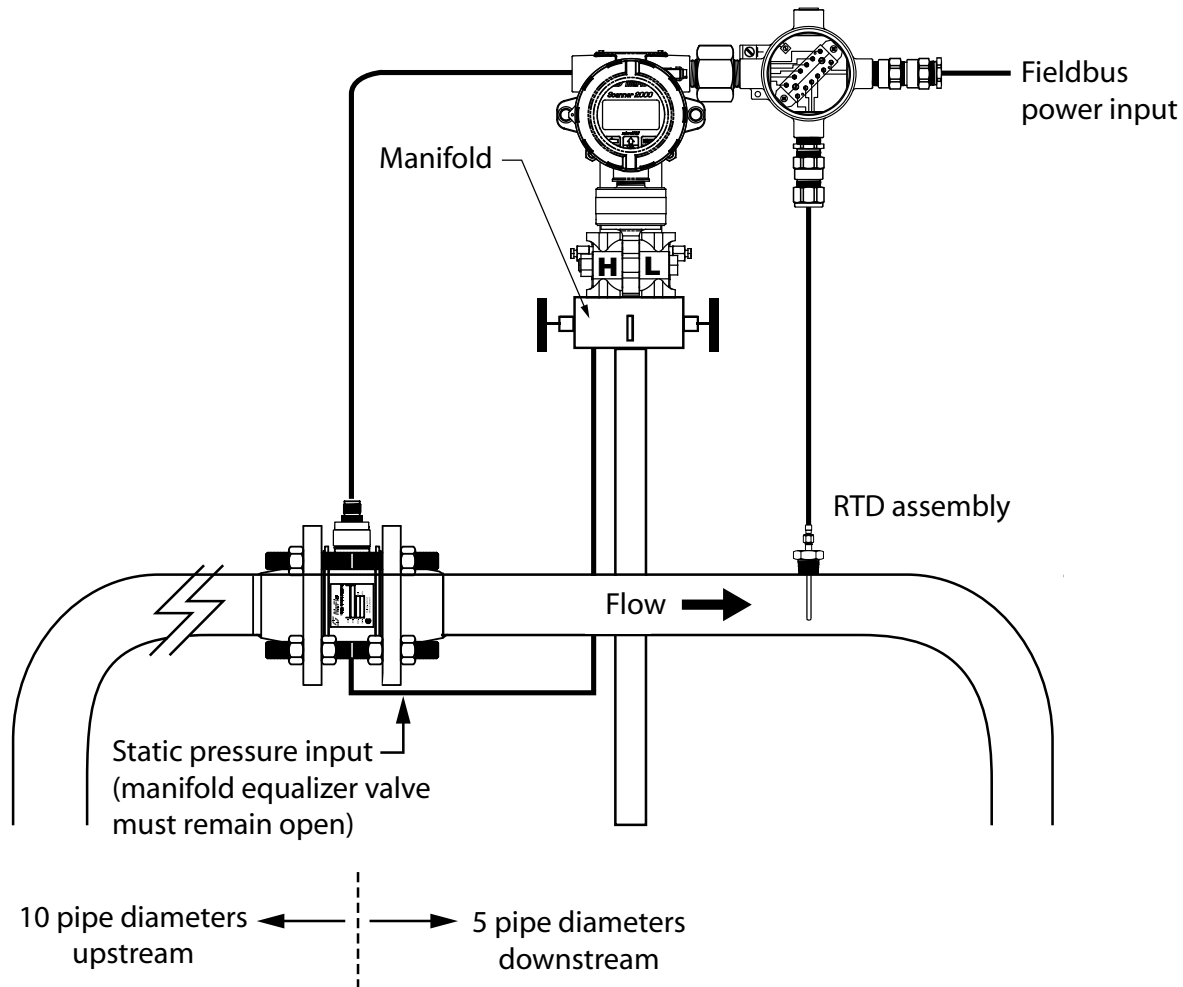

Figure 2.6—Remote-mount installation in an AGA-7 turbine meter run (shown with terminal housing)

6. Install the RTD assembly in the thermowell. Route the RTD assembly cable through the terminal housing cable gland and connect it to the terminal strip inside. See [Figure 3.6, page 51](#), for wiring instructions.
7. Connect the lithium battery to the J1 connector on the main board.
8. Route the FOUNDATION™ fieldbus power cable through the terminal housing and connect it to the fieldbus interface board. See [Figure 3.4, page 49](#), for wiring instructions.

Note Do not connect the fieldbus power cable without first connecting the lithium battery pack to the main board.

9. Zero the static pressure and recalibrate the static pressure, if required. See the ModWorX™ Pro Software User Manual, Part No. 9A-30165025, for complete instructions. See also [Zero Offset \(Static Pressure or Differential Pressure\), page 39](#), and [Static Pressure Calibration and Verification, page 40](#).

CAUTION Do not put the Scanner into operation until the valves are positioned properly so that pressure is supplied to both sides of the MVT. For instructions on proper valve positions, see [Placing the Scanner into Operation, page 42](#).

Measuring Steam via a Differential Pressure Meter

Note This section contains installation guidelines for orifice and cone meters. If installing the Scanner 2000 with an averaging pitot tube meter, refer to manufacturer instructions for installation.

Best Practices

The Scanner 2000 microEFM calculates steam flow in accordance with IF-97, AGA-3, and ISO-5167 industry standards. For optimum performance, ensure that the Scanner 2000 installation complies with the industry recommendations listed below:

Condensate pots

- A condensate pot for a small-volume transducer like the Scanner 2000 MVT can be a simple pipe tee, oriented so that one port extends downward (into the cold leg), the opposite port extends upward and is closed by a pipe cap or blowdown valve, and the tee extends horizontally into the hot leg.
- The pots should be the highest point in the system.
- The pots should be mounted at the same level, and one or both should be adjustable vertically to remove zero shifts in the differential pressure measurement.

Hot legs

- Hot legs should be large diameter (3/8 in. or 1/2 in., if possible)
- Hot legs should be as short as possible. If these sections must be more than 1 ft. in length, insulate them.
- Elbows and bends should not form any traps in which liquid can accumulate.
- Hot legs should be sloped along their entire length to allow liquids to drain back into the pipe.

Cold legs

- Cold legs should enter the multi-variable sensor through its side ports.
- Cold legs should be a minimum of 2 ft in length to allow proper convection cooling and should be run horizontally with a slope of approximately 1 inch per foot to allow air bubbles to float up into the pots.
- Elbows and bends should not form any traps for air bubbles.
- Cold legs should be filled with a suitable antifreeze. Dibutyl phthalate is recommended.

Antifreeze

- Dibutyl phthalate (DBP) has the following advantages over glycol antifreeze:
 - DBP doesn't mix with water, and so doesn't dilute over time; its specific gravity doesn't shift.
 - It is slightly denser than water, so it will stay in the pot permanently.
 - It is non-flammable.
 - It is much less toxic than glycol.
 - It is available from industrial suppliers.

Valves

- Use only full-opening block valves that are rated for steam service.
- Use only blowdown valves that are rated for steam service. Periodic blowdowns are recommended for preventing buildup of scale.

CAUTION Before starting the system, remove the caps and add water or antifreeze if necessary to completely fill the pots and cold legs. Air trapped in the lines will produce errors in differential pressure measurements.

WARNING: EXPLOSION RISK. Housing temperature must not exceed 70°C (158°F). Excessive temperatures, which could result from ambient conditions combined with radiated and conductive heat from the process, could cause the internal lithium battery to ignite or explode.

Installation Procedure—Remote Mount to Orifice Meter or Cone Meter

A Scanner 2000 can be mounted remotely and connected to an orifice meter or cone meter with tubing for steam measurement. The setup of the meter run and plumbing configurations can vary widely, depending upon the challenges existing on location.

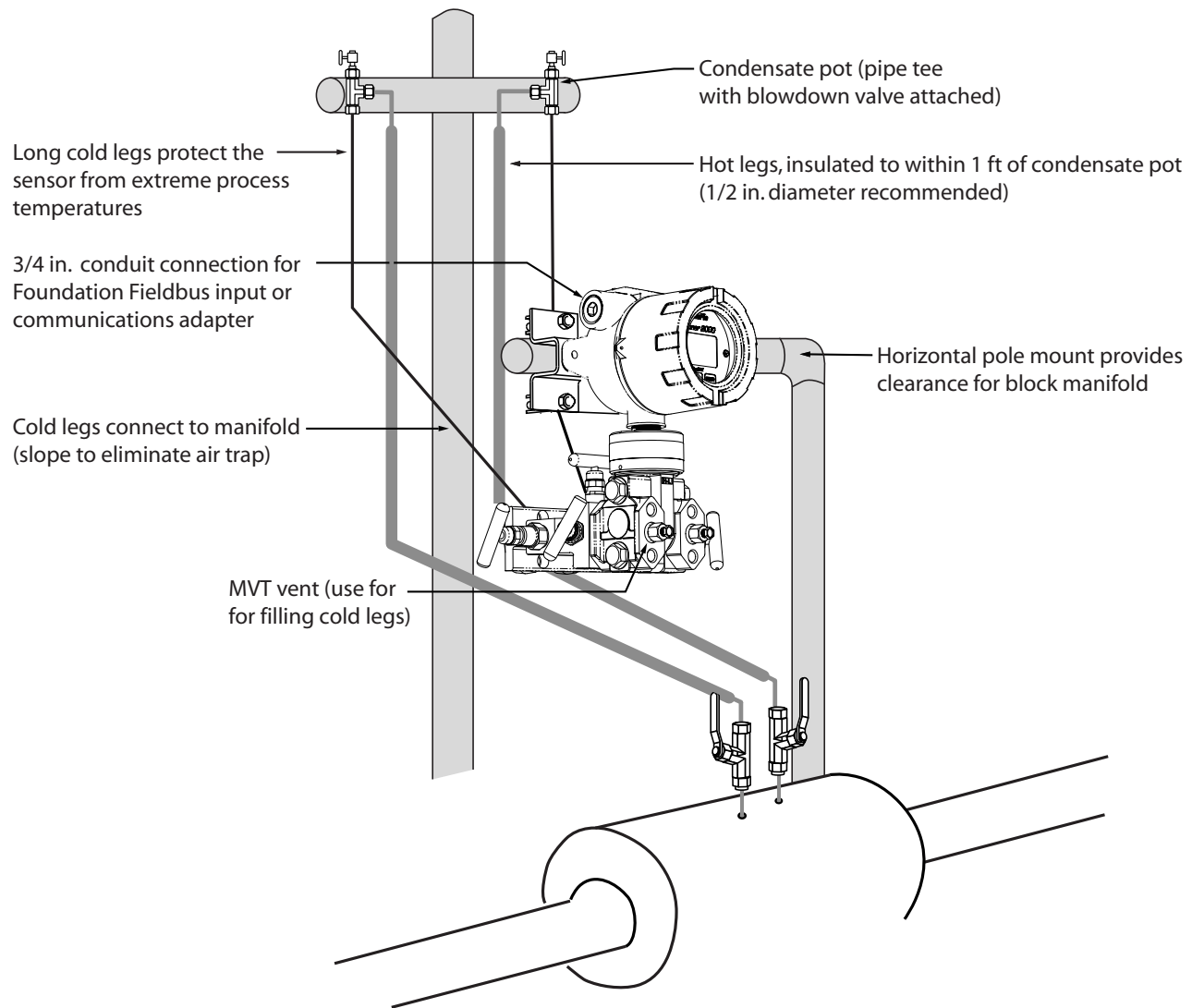

Figure 2.7—Remote-mount steam run installation (shown here with a cone meter). The remote-mount method can be used with an orifice meter as well.

CAUTION When measuring steam, process connections must be designed to eliminate air pockets. This is achieved by making sure all tubing in the cold legs slopes upward. A side-port MVT and block manifold (shown in Figure 2.9) is recommended to help prevent air bubbles from being trapped in the sensor.

If a bottom-port MVT is used, the bottom process ports must be plugged or replaced with a drain valve, and side vents must be used for process connections. A block manifold is not recommended for use with bottom port MVTs. Contact a Cameron field representative for assistance.

1. Verify that the meter is properly installed in the flow line (per manufacturer's instructions).
2. Mount the Scanner 2000 to a 2-in. pipe or to a flat, vertical surface using bolts and the mounting holes in the enclosure. A horizontal pipe is recommended, as additional hardware may be required for a vertical pipe mount to provide clearance for the manifold block.
3. Mount a set of pipe tees (which serve as condensate pots) typically on either side of the Scanner 2000 at an elevation above the process connections of the Scanner 2000 MVT (for proper drainage). They should be a considerable distance (4 ft) from the sensor ports, but as close as possible to the pressure taps on the meter.
4. Install a pipe cap or a blowdown valve that is rated for steam service at the top of each pipe tee. A blowdown valve is recommended when the steam passing through the meter is known to be dirty.
5. Install tubing and fittings to connect the high-pressure and low-pressure taps of the DP meter to the pipe tees. This section is typically referred to as the *hot legs* of the installation, as this section of tubing encounters steam at its highest temperature. Install a shut-off valve near the high and low ports of the DP meter. Use a suitable compound or tape on all threaded process connections.

CAUTION Whenever possible, locate the hot legs of a steam installation behind the Scanner 2000 safely out of the operator's normal reach. This will help prevent accidental burns.

6. Connect the lithium battery to the J1 connector on the main board.
7. Route the FOUNDATION™ fieldbus power cable through the conduit opening in the top of the Scanner 2000 and connect to the fieldbus interface board. See [Figure 3.4, page 49](#), for wiring instructions.

Note If a terminal housing is used, FOUNDATION™ fieldbus power may be routed through the terminal housing cable glands and connected to the terminal strip inside. Do not connect the fieldbus power cable without first connecting the lithium battery pack to the main board.

Note To prevent fittings from turning and/or to avoid putting tension on stainless steel tubing, use a backup wrench to attach stainless steel tubing to shut-off valves, or sensor ports.

8. Install tubing to connect the high-pressure and low-pressure process connections of the block manifold to the pipe tees installed in step 3. This tubing section is typically referred to as the cold legs of the installation, since it is filled with water.
9. To eliminate air bubbles, fill the cold legs with water or other fill fluid from the lowest point in the system, typically the MVT, using the following steps:
 - a. Open the blowdown valve or remove the filling plug from one of the pipe tees/condensate pots.

- b. Open the equalizer and bypass/block valves on the block manifold. Make sure the vent valve is closed.
 - c. Remove the corresponding (high pressure or low pressure) vent screw from the side of the MVT and insert a fitting to allow connection of a hand pump or funnel. If a funnel is used, attach a length of Tygon tubing that is long enough to elevate the funnel well above the condensate pot to force the fluid up the legs.
 - d. Connect a hand pump or funnel to the fitting.
 - e. Pour fill liquid into the funnel or pump it into the cold leg, tapping the cold leg occasionally to dislodge any bubbles.
 - f. Observe the pipe tee/condensate pot and stop pouring when the fill liquid is visible at the top and no air bubbles can be seen.
 - g. Remove the fitting from the vent of the MVT and quickly replace the vent screw and tighten.
 - h. Close the blowdown valve or replace the filling plug from one of the pipe tees/condensate pots.
 - i. Repeat steps a through h for the other cold leg.
10. To eliminate an offset of the differential pressure reading, open the equalizer valves on the block manifold, remove the caps from the seal pots, and adjust either seal pot vertically to bring the water levels to the exact same elevation.
 11. Perform a manifold leak test as described on page 39.
 12. Verify the zero offset, if required (and other calibration points, if desired). See the ModWorX™ Pro Software User Manual, Part No. 9A-30165025, for complete instructions. See also [Zero Offset \(Static Pressure or Differential Pressure\)](#), page 39, [Static Pressure Calibration and Verification](#), page 40, and [Differential Pressure Calibration and Verification](#), page 41.

CAUTION Do not put the Scanner into operation until the valves are positioned properly so that pressure is supplied to both sides of the MVT. For instructions on proper valve positions, see [Placing the Scanner into Operation](#), page 42.

Measuring Liquid via a Differential Pressure Meter

Note This section contains installation guidelines for orifice and cone meters. If installing the Scanner 2000 with an averaging pitot tube meter, refer to manufacturer instructions for installation.

Best Practices

To ensure measurement accuracy, ensure that the meter run complies with the following AGA-3 and ISO 5167 guidelines, as applicable:

- Do not place unit near vents or bleed holes that discharge corrosive vapors or gases.
- Consider the orientation of the meter run when determining the best position for mounting the Scanner.
 - If the Scanner 2000 is mounted to a horizontal pipeline, make sure process connections are horizontal with the pipeline, or sloped downwards towards the Scanner. Mount the Scanner 2000 below the pressure taps at the pipe. Use the side (upper) ports as process connections and the bottom ports for draining and filling the DP housings.
 - If the Scanner 2000 is mounted to a vertical pipeline, install the sensor below the differential pressure source connections. Slope all tubing downward at least 1-inch/linear foot to avoid gas entrapment.
- Mount the Scanner 2000 as near level as possible such that the operator has a clear view of the LCD, and can access the keypad easily when the enclosure cover is removed. The location should be as free from vibration as possible.
- Make sure the high port of the sensor (marked “H”) is connected to the upstream side of the meter run.
- Pipe diameters (D) should be between 2 in. (50 mm) and 39 in. (1000 mm) per ISO 5167; or greater than 2 in. (50 mm) per AGA-3.
- Pipe Reynolds numbers must be above 5000. Avoid high-viscosity liquids (greater than 15 cP).
- d (orifice diameter) must be greater than or equal to 0.45 in. (11.5 mm).
- Orifice β (diameter ratio) must be greater than or equal to 0.1 and less than or equal to 0.75.
- Gauge lines should be of uniform internal diameter and constructed of material compatible with the fluid being measured. For most applications, the bore should be no smaller than ¼ in. (6 mm) and preferably, 3/8 in. (10 mm) in diameter. The internal diameter should not exceed 1 in. (25 mm). If high-temperature fluids are likely to be encountered, make sure the measuring tube used is rated for the anticipated temperature range. See also the warning in the Operating Temperature section of the Specifications Table (page 11).
- If there is possibility of freezing, the gauge lines can be filled with a suitable seal liquid. The seal liquid should be somewhat denser than the process fluid, should not dissolve in it, should have a sufficiently low freezing point, and should be non-toxic. Alternatively, heat tracing can be used.
- Gauge line length should be minimized to help prevent pulsation-induced errors.
- Gauge lines should slope upward to the meter at a minimum of one inch per foot.
- If gauge lines must slope in more than one direction, do not allow more than one bend and install a gas trap.
- Gauge lines should be supported to prevent sag and vibration.
- Where pulsation is anticipated, full-port manifold valves with a nominal internal diameter consistent with the gauge lines are recommended.

If the Scanner 2000 is mounted to a cone meter, consider the following guidelines in addition to the best practices listed above.

- Position the cone meter so that there are zero to five pipe diameters upstream of the meter and zero to three pipe diameters downstream of the meter.
- Install the meter so that the static pressure tap is upstream of the differential pressure tap. The high side of the integral Scanner 2000 sensor must also be situated upstream.
- Install shut-off valves directly on the DP meter pressure taps. Choose a shut-off valve that is rated for the ambient temperatures of the location and the operating pressure of the pipe in which it will be installed, and for use with dangerous or corrosive fluids or gases, if applicable. The valves must not affect the transmission of the differential pressure signal.

Installation Procedure—Direct Mount to Orifice Meter or Cone Meter

A Scanner 2000 can be mounted directly to an orifice meter or cone meter for liquid measurement using a side-port MVT, a block manifold and two football flange adapters (Figure 2.8). The setup of the meter run and plumbing configurations can vary widely, depending upon the challenges existing on location.

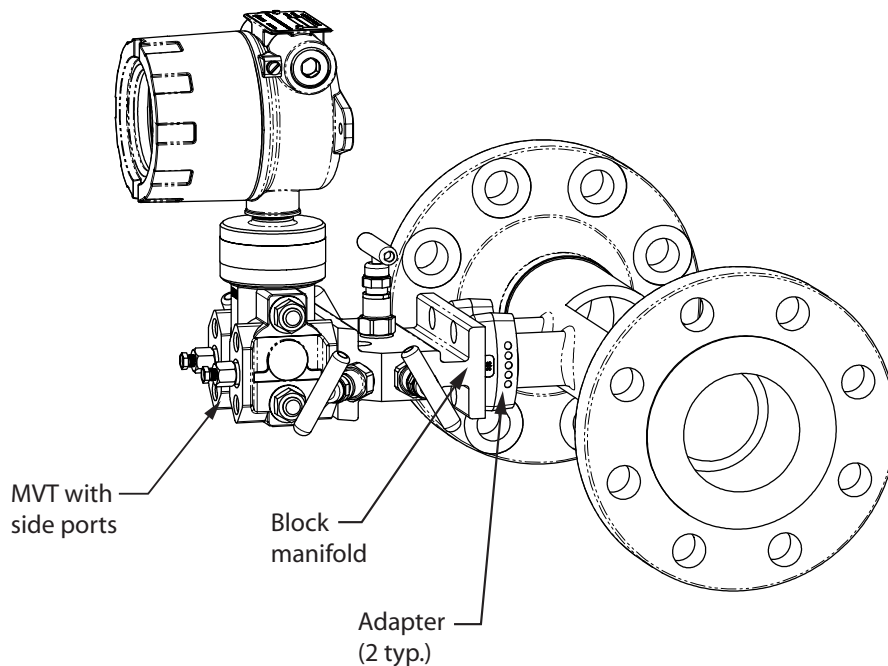

Figure 2.8—Direct-mount liquid run installation (shown here with a cone meter). Downstream RTD is not shown.

CAUTION When measuring liquid with a direct-mount Scanner 2000, process connections must be parallel to the horizontal centerline of the meter, or below the centerline to eliminate air pockets.

1. Verify that the meter is properly installed in the flow line (per manufacturer's instructions).
2. Screw a football flange adapter onto each meter pressure tap using pipe tape or pipe dope to seal the threads.

3. Align the bolt holes in the Scanner 2000 MVT and manifold, and install bolts to mate these components to the football flanges, using o-rings as appropriate. Torque the bolts to the manufacturer's specification.
4. Connect the lithium battery to the main board connector.
5. Route the FOUNDATION™ fieldbus power cable through the conduit opening in the top of the Scanner 2000 and connect to the fieldbus interface board. See [Figure 3.4, page 49](#), for wiring instructions.
6. Verify that all manifold valves are closed, and fill the meter with process fluid.
7. Loosen one of the vent screws in the side of the MVT.
8. Open the equalizer valves and the vent valve on the manifold.
9. Slowly open one of the bypass/block valves on the manifold. Process fluid should immediately spurt from the MVT vent.
10. When air bubbles are no longer visible around the MVT vent, tighten the MVT vent screw.
11. Loosen the other vent screw in the side of the MVT, and repeat steps 7 through 9.
12. Perform a manifold leak test as described on page 39.
13. Verify the zero offset, if required (and other calibration points, if desired). See the ModWorX™ Pro Software User Manual, Part No. 9A-30165025, for complete instructions. See also [Zero Offset \(Static Pressure or Differential Pressure\), page 39](#), [Static Pressure Calibration and Verification, page 40](#), and [Differential Pressure Calibration and Verification, page 41](#).

CAUTION Do not put the Scanner into operation until the valves are positioned properly so that pressure is supplied to both sides of the MVT. For instructions on proper valve positions, see [Placing the Scanner into Operation, page 42](#).

Installation Procedure—Remote Mount to Orifice Meter or Cone Meter

A Scanner 2000 can be mounted remotely and connected to an orifice meter or cone meter with tubing for liquid measurement ([Figure 2.9, page 36](#)). The setup of the meter run and plumbing configurations can vary widely, depending upon the challenges existing on location.

CAUTION When measuring liquid, process connections must be designed to eliminate air pockets. This is achieved by mounting the sensor below the metering device and sloping all tubing downward from the meter to the sensor. A side-port MVT and block manifold (shown in [Figure 2.11](#)) is recommended to help prevent air bubbles from being trapped in the sensor.

If a bottom-port MVT is used, the bottom process ports must be plugged or replaced with a drain valve, and side vents must be used for process connections. A block manifold is not recommended for use with bottom port MVTs. Contact a Cameron field representative for assistance.

1. Verify that the meter is properly installed in the flow line (per manufacturer's instructions).
2. Mount the Scanner 2000 to a 2-in. pipe or to a flat, vertical surface using bolts and the mounting holes in the enclosure. A horizontal pipe is recommended, as additional hardware may be required for a vertical pipe mount to provide clearance for the manifold block.

3. Install tubing and fittings to connect the high-pressure and low-pressure taps of the DP meter to the process connections of the block manifold. Install a pair of shut-off valves near the high and low ports of the DP meter. Use a suitable compound or tape on all threaded process connections.
4. Install the RTD assembly in the thermowell. Route the RTD assembly cable through the conduit opening in the top of the Scanner 2000 and connect it to the main circuit board. See [Figure 3.6, page 51](#), for wiring instructions.
5. Connect the lithium battery to the J1 connector on the main board.
6. Route the FOUNDATION™ fieldbus power cable through the conduit opening in the top of the Scanner 2000 and connect to the fieldbus interface board. See [Figure 3.4, page 49](#), for wiring instructions.

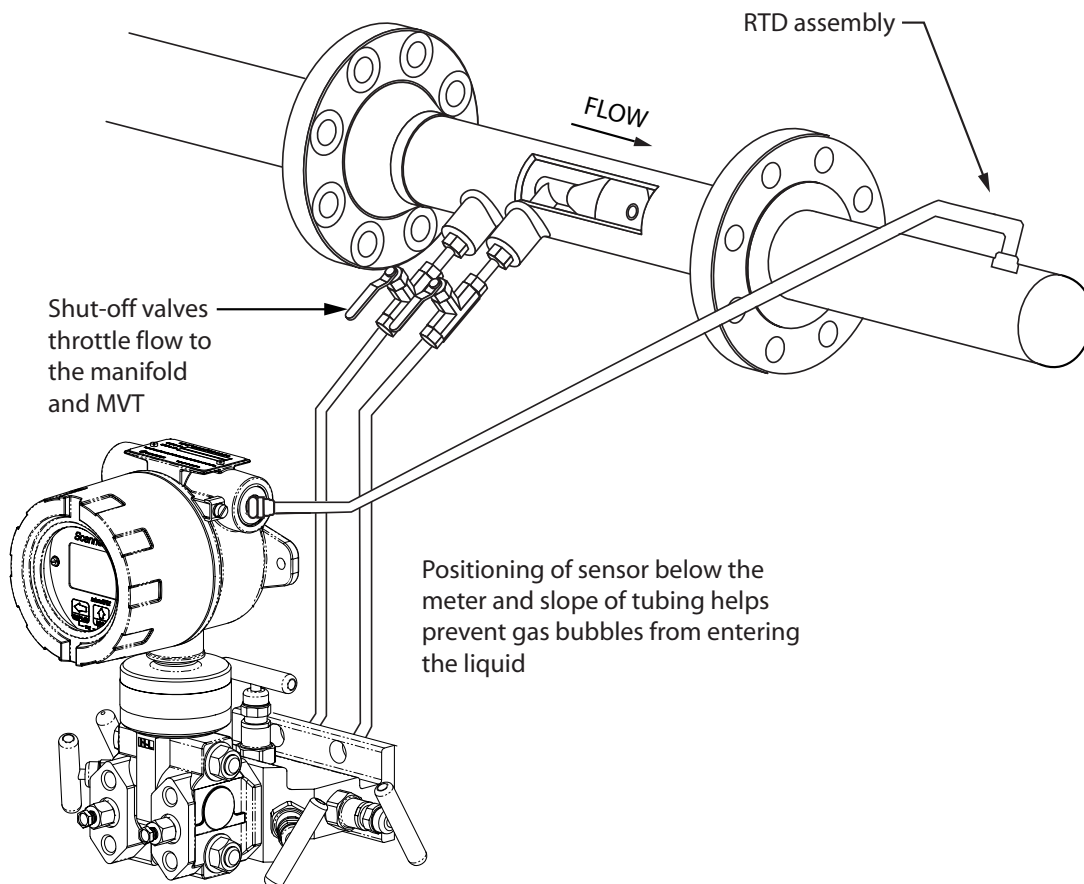

Figure 2.9—Remote-mount liquid run installation (shown here with a cone meter). The remote-mount method can be used with an orifice meter as well.

Note If a terminal housing is used, FOUNDATION™ fieldbus power and RTD assembly cables may be routed through the terminal housing cable glands and connected to the terminal strip inside. Do not connect the fieldbus power cable without first connecting the lithium battery pack to the main board.

Note To prevent fittings from turning and/or to avoid putting tension on stainless steel tubing, use a backup wrench to attach stainless steel tubing to shut-off valves, or sensor ports.

7. To eliminate air bubbles in the MVT, manifold, and legs connecting them to the meter, fill the legs with fluid. Choose a fluid that is safe for the environment, and stable when depressurized.
-

Important If the process fluid does not present an environmental risk and is stable when depressurized, it may be used to bleed air from the lines. If the process fluid can contaminate the environment, or is highly volatile when depressurized as with liquified gases, a different seal fluid should be used to fill the legs. An ideal seal fluid is one that does not dissolve in the process fluid.

Bleeding with Process Fluid

- a. Make sure the shut-off valves in the tubing near the meter pressure taps are closed, and the meter is filled with process fluid.
- b. Open the equalizer and bypass/block valves on the block manifold. Make sure the vent valve is closed.
- c. Open one of the shut-off valves near the meter.
- d. Slowly loosen the corresponding vent screw on the MVT, and throttle the rate of flow from the vent with the shut-off valve.
- e. When air bubbles are no longer visible around the MVT vent, tighten the MVT vent screw.
- f. Repeat steps a through e for the other leg.

Bleeding with a Different Seal Fluid

- a. Make sure the shut-off valves in the tubing near the pressure taps are open.
 - b. Open the equalizer and bypass/block valves on the block manifold. Make sure the vent valve is closed.
 - c. Remove the vent screw from one side of the MVT and insert a fitting to allow connection of a hand pump or funnel. If a funnel is used, attach a length of Tygon tubing that is long enough to elevate the funnel well above the meter pressure taps to force the fluid up the legs.
 - d. Connect a hand pump or funnel to the fitting.
 - e. Estimate the amount of fill fluid required to fill the tubing and push any air bubbles into the meter.
 - f. Pour fill liquid into the funnel, tapping the tubing occasionally to dislodge any bubbles.
 - g. When the leg is full of fluid, remove the fitting from the vent of the MVT and quickly replace the vent screw and tighten.
 - h. Repeat steps a through g for the other leg.
8. Perform a manifold leak test as described on page 39.
 9. Verify the zero offset, if required (and other calibration points, if desired). See the ModWorX™ Pro Software User Manual, Part No. 9A-30165025, for complete instructions. See also [Zero Offset \(Static Pressure or Differential Pressure\)](#), page 39, [Static Pressure Calibration and Verification](#), page 40, and [Differential Pressure Calibration and Verification](#), page 41.

CAUTION Do not put the Scanner into operation until the valves are positioned properly so that pressure is supplied to both sides of the MVT. For instructions on proper valve positions, see [Placing the Scanner into Operation](#), page 42.

Measuring Liquid via a Turbine Meter

Best Practices

The Scanner 2000 microEFM calculates uncompensated liquid flow through a turbine meter in accordance with API MPMS, Chapter 5, Section 3, Measurement of Liquid Hydrocarbons by Turbine Meters. The Scanner 2000 microEFM calculates compensated liquid flow through a turbine meter in accordance with API-2540 and the measurement principles upon which the AGA-7 standard is based. The user supplies a linear or multi-point calibration factor, and the instrument performs the required compensation calculations, based on the RTD input.

For optimum performance, ensure that the turbine and Scanner 2000 installation complies with the industry recommendations listed below:

- Install the turbine flowmeter in the meter run such that there are at least 10 nominal pipe diameters upstream and five nominal pipe diameters downstream of the meter. Both inlet and outlet pipe should be of the same nominal size as the meter.
- Straightening vanes are recommended for eliminating swirl conditions. If used, they should be installed five pipe diameters upstream of the meter.

Installation Procedure—Direct Mount to a Turbine Meter

A Scanner 2000 without the MVT bottomworks can be mounted directly to a liquid turbine meter for measuring liquid (Figure 2.10). A pipe adapter and union are attached to the Scanner, allowing a direct connection to the turbine meter.

Important Use only with ATEX-approved IS-rated pickups. For NuFlo turbine meters, use Part No. 9A-99145007 or 9A-99145008. For Barton 7000 meters, use Part No. 9A-2113-001A-01 or 9A-2113-001A-02. See Spare Parts list, page 81, for descriptions.

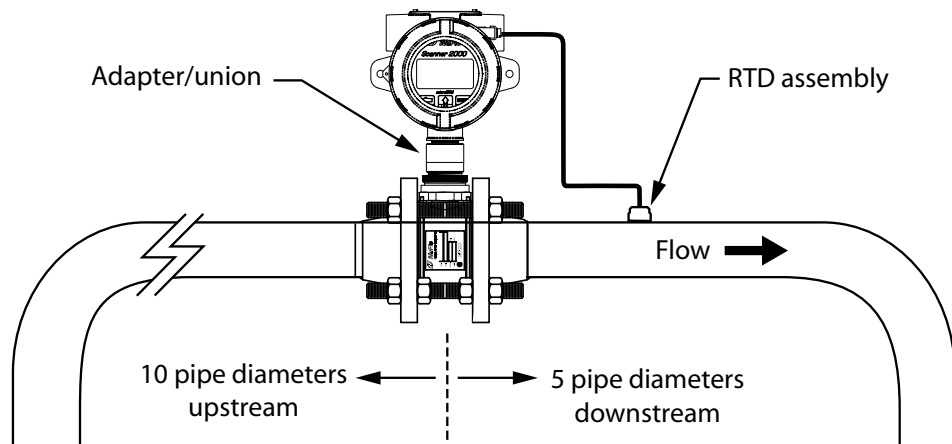

Figure 2.10—Direct-mount installation for use with a Barton 7000 Series meter

To connect the Scanner 2000 to a liquid turbine meter using this method, perform the following steps:

1. Position the Scanner 2000 above the flowmeter.
2. Plug the Scanner 2000 cable connector into the magnetic pickup of the turbine meter and hand-tighten the knurled nut on the connector.

3. Screw the Scanner 2000 onto the flowmeter threads surrounding the magnetic pickup with the display facing the desired direction.
4. Tighten all sections of the pipe union.
5. Connect the lithium battery to the main board connector.
6. Route the FOUNDATION™ fieldbus power cable through the conduit opening in the top of the Scanner 2000 and connect to the fieldbus interface board.

Performing a Manifold Leak Test

A manifold leak test is recommended prior to operating any differential pressure meter into service. Check the manifold for leaks as follows.

1. Verify that the instrument is approximately level and is properly connected to the pressure source.
2. Make sure the vent valve in the manifold is closed. (The bypass/block valves should be open.)
3. Close both bypass/block valves on the manifold to isolate pressure between the block valve and the MVT.
4. Open both equalizer valves to distribute pressure throughout.
5. Monitor the pressure readout and watch for a steady decrease in pressure. If leakage is indicated, depressurize the system by opening both bypass/block valves, then check all manifold and piping joints. Tighten connections as necessary.
6. Repeat steps 3 through 5 to retest the manifold for leaks.

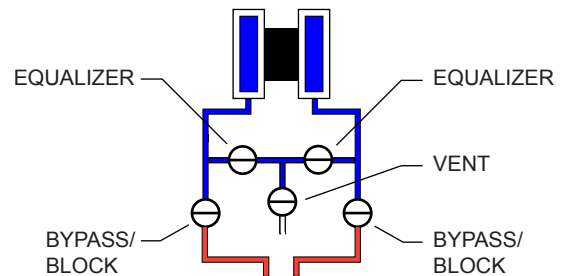

An additional test can verify the condition of the equalizing valves. Assuming the above test has confirmed the system is leak free, close both equalizing valves and open the vent. Monitor the differential pressure reading for any change. Repair or replace the manifold as required if the differential pressure varies.

Zero Offset (Static Pressure or Differential Pressure)

The static pressure input for the Scanner 2000 is zeroed at the factory before shipment. However, changes in temperature and atmospheric pressure can cause the static pressure and differential pressure readings to vary. The inputs can be easily zeroed in the field, if necessary, prior to putting the Scanner 2000 into service.

Zero the static pressure or differential pressure as follows.

1. Close the bypass valves to isolate the pressure below the manifold.
2. Open the equalizer and vent valves.
3. Connect to the Scanner 2000 with the ModWorX™ Pro software, and apply zero pressure from the Calibrate Inputs screen (see the ModWorX™ Pro Software User Manual; Part No. 9A-30165025; for complete instructions).

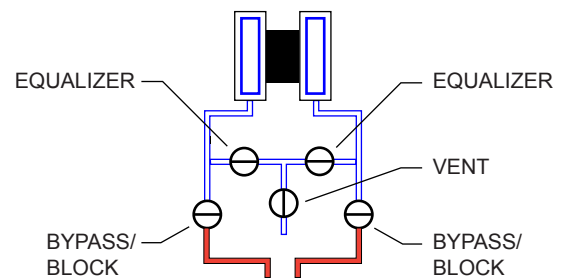

Static Pressure Calibration and Verification

Note The pressure range stamped on the MVT is expressed as psia (absolute). However, Scanner 2000 pressure inputs are recalibrated as psig (gauge) at the factory before the device is shipped. Therefore, pressure readings displayed on the LCD and in the ModWorX Pro software are in terms of psig.

The static pressure and differential pressure inputs are calibrated and verified before the Scanner 2000 leaves the factory, and recalibration in the field may or may not be required. To comply with API standards for verification, “as found” readings should be recorded at approximately 0, 50, and 100 percent of the operating pressure range, increasing, and at 80, 20 and 0 percent of the operating pressure range, decreasing. For example, the static pressure measurements of a 1500-psi sensor should be verified at 0 psi, 750 psi, and 1500 psi, then at 1200 psi, 300 psi, and 0 psi.



WARNING: Do not subject the Scanner 2000 microEFM to unnecessary shock or over-range pressure during maintenance operations.

To calibrate the static pressure

1. Close the bypass valves to isolate the pressure below the manifold.
2. Open the equalizer valves and vent valve to purge the lines.
3. Close the vent valve.
4. Connect a static pressure simulator to the manifold (either side).
5. Connect to the Scanner 2000 with the ModWorX™ Pro software. Click on the **Calibrate Inputs** menu button and proceed through the calibration per instructions in the ModWorX™ Pro Software User Manual.
6. At the appropriate software prompt, enter a known pressure.
7. Apply the same amount of pressure to the MVT using the simulator (see the ModWorX™ Pro Software User Manual for complete instructions). The ModWorX™ Pro software will display a measured value and a percentage of change.
8. Repeat steps 6 and 7 as necessary to enter multiple calibration points.
9. When all calibration points have been entered, click **Save Changes** to apply the new calibration settings.

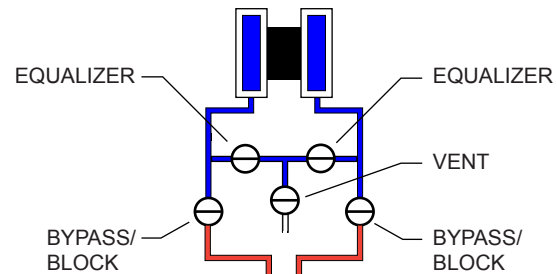

To verify the static pressure, perform the steps described in the calibration procedure above, except instead of choosing **Calibrate** from the Change Calibration Task window, choose **Verify**. You will be prompted to enter an applied value, and you will apply the same amount of pressure to the MVT, just as in the calibration process. The ModWorX™ Pro software will display a measured value and a percentage of error. When you click **Save Changes**, the measured values are written to memory for reference.

Differential Pressure Calibration and Verification

The static pressure and differential pressure inputs are calibrated and verified before the Scanner 2000 leaves the factory, and recalibration in the field may or may not be required. To comply with API standards for verification, “as found” readings should be recorded at approximately 0, 50, and 100 percent of the operating pressure range, increasing, and at 80, 20 and 0 percent of the operating pressure range, decreasing. For example, the differential pressure measurements of a 200-In. H₂O sensor should be verified at 0 In. H₂O, 100 In. H₂O, 200 In. H₂O, then at 160 In. H₂O, 40 In. H₂O, and 0 In. H₂O.



WARNING: Do not subject the Scanner 2000 microEFM to unnecessary shock or over-range pressure during maintenance operations.

To calibrate the differential pressure

1. Close the bypass valves to isolate the pressure below the manifold.
2. Open the equalizer valves and vent valve to purge the lines.
3. Close the high-pressure side equalizer valve.
4. Connect a pressure simulator to the high-pressure side of the manifold.
5. Connect to the Scanner 2000 with the ModWorX™ Pro software. Click on the **Calibrate Inputs** menu button and proceed through the calibration per instructions in the ModWorX™ Pro Software User Manual, Part No. 9A-30165025.
6. At the appropriate software prompt, enter a known pressure.
7. Apply the same amount of pressure to the high side of the MVT using the simulator (see the ModWorX™ Pro Software User Manual, Part No. 9A-30165025, for complete instructions). The ModWorX™ Pro software will display a measured value.
8. Repeat steps 6 and 7 as necessary, to enter multiple calibration points, and apply the new measured values from the ModWorX™ Pro interface.
9. When all calibration points have been entered, click **Save Changes** to apply the new calibration settings.

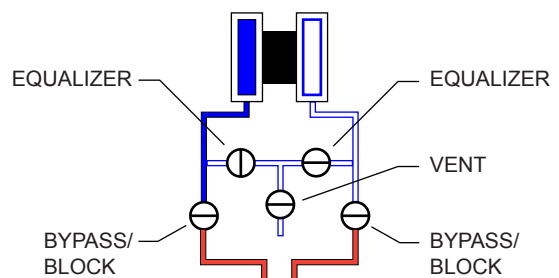

To verify the differential pressure, perform the steps described in the calibration procedure above, except instead of choosing **Calibrate** from the Change Calibration Task window, choose **Verify**. You will be prompted to enter an applied value, and you will apply the same amount of pressure to the MVT, just as in the calibration process. The ModWorX™ Pro software will display a measured value and a percentage of error. When you click **Save Changes**, the measured values are written to memory for reference.

Placing the Scanner into Operation

To put the Scanner into operation:

1. Close the vent valve.
2. Open the equalizer valves.
3. Open the bypass/block valves to allow pressure to be supplied to both sides of the MVT.
4. Close the equalizer valves.
5. Open the vent valve (optional, some users may choose to leave the vent closed).

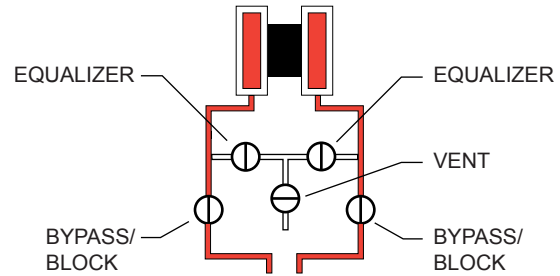

Industry Standard Compliance

To ensure measurement accuracy, flow runs and turbine meter runs must be installed in accordance with industry standards. [Table 2.2, page 42](#), and [Table 2.3, page 43](#), reference the sections in these standards that apply specifically to flow run and hardware installation.

[Table 2.4, page 44](#), references standards that apply to fluid properties for gas, steam, and liquid measurement. Fluid properties used for gas measurement calculations such as compressibility factors and density are in accordance with AGA Report No. 8. For steam measurement, algorithms are based on the IAPWS Industrial-Formulation 1997 (IF-97) standard. For temperature-compensated liquid measurement, fluid property calculations are based on API-2540 - 1980, Petroleum Measurement Tables.

Heating values for gas measurement are calculated in accordance with AGA Report No. 3, Part 3, Appendix F, using the constants defined in GPA 2145.

For more information, see the ModWorX™ Pro Software User Manual, Part No. 9A-30165025.

Table 2.2—Industry Standards for Orifice Meters

Standard	Applicable Section	Description	Notes
AGA Report No. 3: Orifice Metering of Natural Gas and Other Related Hydrocarbon Fluids	Part 2: Specification and Installation Requirements, Section 2.6 (Installation requirements)	Specifications for orifice meters (to include beta ratios) Installation requirements for orifice plates, meter tubes, flow conditioners, and thermometer wells	This standard is also distributed under the following names: API MPMS Chapter 14.3, Part 2; ANSI/API 14.3, Part 2-2000; and GPA 8185, Part 2.
ISO 5167: Measurement of Fluid Flow by Means of Pressure Differential Devices Inserted in Circular Cross-Section Conduits Running Full	Part 1: General Principles and Requirements	Installation of orifice plates inserted into a circular cross-section conduit running full Limitation of pipe size and Reynolds number	ISO 5167 is applicable only to flow that remains subsonic throughout the measuring section and where the fluid can be considered single-phase. It is not applicable to the measurement of pulsating flow. It does not cover the use of orifice plates in pipe sizes less than 50 mm (2 in.) or more than 1000 mm (39 in.), or for pipe Reynolds numbers below 5000.
ISO 5167: Measurement of Fluid Flow by Means of Pressure Differential Devices Inserted in Circular Cross-Section Conduits Running Full	Part 2: Orifice Plates	Specifies orifice plates that can be used with flange pressure tappings, corner pressure tappings, D and D/2 pressure tappings.	
API Manual of Petroleum Measurement Standards, Chapter 21.1 (Electronic Gas Measurement)	Section 1.7 -Equipment Installation	Installation of electronic gas measurement devices and associated communications, gauge/ impulse lines, and cabling	
	Section 1.8 -Equipment Calibration and Verification	Requirements for calibrating and verifying the accuracy of electronic gas measurement devices	

Industry Standards for Cone Meters

For installation requirements for use with a cone meter and applicable flow rate calculations, see the NuFlo Cone Meter User Manual, Part No. 9A-85165000.

Table 2.3—Industry Standards for Turbine Meters

Standard	Applicable Section	Description	Notes
AGA Report No. 7: Measurement of Natural Gas by Turbine Meters	Section 7- Installation Specifications	Installation of gas turbine meters to include flow direction, meter orientation, meter run connections, internal surfaces, temperature well location, pressure tap location, and flow conditioning Illustrations of recommended installation configurations Environmental considerations, the use of other devices to improve meter performance, and precautionary measures.	This specification applies to axial-flow turbine flowmeters for measurement of natural gas, typically 2-in. and larger bore diameter, in which the entire gas stream flows through the meter rotor.
API Manual of Petroleum Measurement Standards, Chapter 21.1 (Electronic Gas Measurement)	Section 1.7 -Equipment Installation	Installation of electronic gas measurement devices and associated communications, gauge/impulse lines, and cabling	
	Section 1.8 -Equipment Calibration and Verification	Requirements for calibrating and verifying the accuracy of electronic gas measurement devices	
API Manual of Petroleum Measurement Standards, Chapter 5 (Metering)	Section 3, Measurement of Liquid Hydrocarbons by Turbine Meters	Description of unique installation requirements and performance characteristics of turbine meters in liquid hydrocarbon service	This section does not apply to the measurement of two-phase fluids.

Table 2.4—Industry Standards for Fluid Properties

AGA Report No. 3, "Orifice Metering of Natural Gas and Other Related Hydrocarbon Fluids," Part 3, "Natural Gas Applications," Third Edition, 1992, Appendix F, "Heating Value Calculation," American Gas Association, catalog XQ9210.
GPA 2145-09, "Table of Physical Properties for Hydrocarbons and Other Compounds of Interest to the Natural Gas Industry," Gas Processors Association, Tulsa Oklahoma, 2008.
AGA Report No 8, "Compressibility Factors of Natural Gas and Other Related Hydrocarbon Gases," Second Edition, AGA Catalogue XQ9212, American Gas Association, Arlington Virginia 1994.
W. Wagner and A. Kruse, "Properties of Water and Steam - The Industrial Standard IAPWS-IF97 for the Thermodynamic Properties and Supplementary Equations for Other Properties," Springer-Verlag, Berlin Heidelberg 1998, ISBN 3-540-64339-7.
API-2540, "Petroleum Measurement Tables," American Petroleum Institute, 1980.

Section 3—Wiring the Scanner 2000

Field Wiring Connections

CAUTION See ANSI/ISA RP12.06.01-2003, *Recommended Practice for Wiring Methods for Hazardous (Classified) Locations Instrumentation* for wiring instructions. Local wiring ordinances may also apply. Terminal block screws must be tightened to a minimum torque of 5 to 7 in-lbs. to secure the wiring within the terminal block. Only personnel who are experienced with field wiring should perform these procedures.

The Scanner 2000 is bus-powered by a two-conductor fieldbus cable that provides both power and communications. A Scanner may be added to the network or removed from the network while the bus is running.

Field wiring is connected to two integral circuit boards inside the Scanner 2000.

- The main board includes terminals for a communications port, a turbine input, a process temperature (RTD) input, a digital output, and a lithium battery connector (for backup power).
- The fieldbus interface board includes terminals for FOUNDATION™ fieldbus power/communications.

A white potted fieldbus module (Figure 3.1) is attached to the fieldbus interface board, but it has no customer inputs/outputs. It is used solely for converting Modbus signals received from the main board to FOUNDATION™ fieldbus H1 protocol that can be read and transmitted via a fieldbus network.

Fieldbus Cable

Use only Type A twisted shielded pair cable to connect the fieldbus network to the Scanner 2000. To help prevent noise, the shield should cover at least 90 percent of the total wire length.

For best performance, adhere to the following best practices for wiring:

- Never run instrument cable next to power cables in cable trays or near heavy electrical equipment.
- Make sure the cable is continuously connected throughout the fieldbus segment.
- Make sure the cable is securely connected to an earth ground near the power supply connection.
- If the shield is connected to the enclosure, ensure that the exposed shield connection is as short as possible to minimize noise.

CAUTION Never connect an instrument signal conductor to a safety ground. Doing so could shut down the entire fieldbus segment.

Basic Wiring

A standard Scanner 2000 with MVT has two conduit openings in the top of its housing for field wiring.

The following procedure describes the steps for wiring a standard Scanner 2000 for operation using the fieldbus power supply and one additional input or output. If additional inputs/outputs are required, a terminal housing is recommended. See [Terminal Housing \(Part No. 2296352-01\)](#), page A-4.

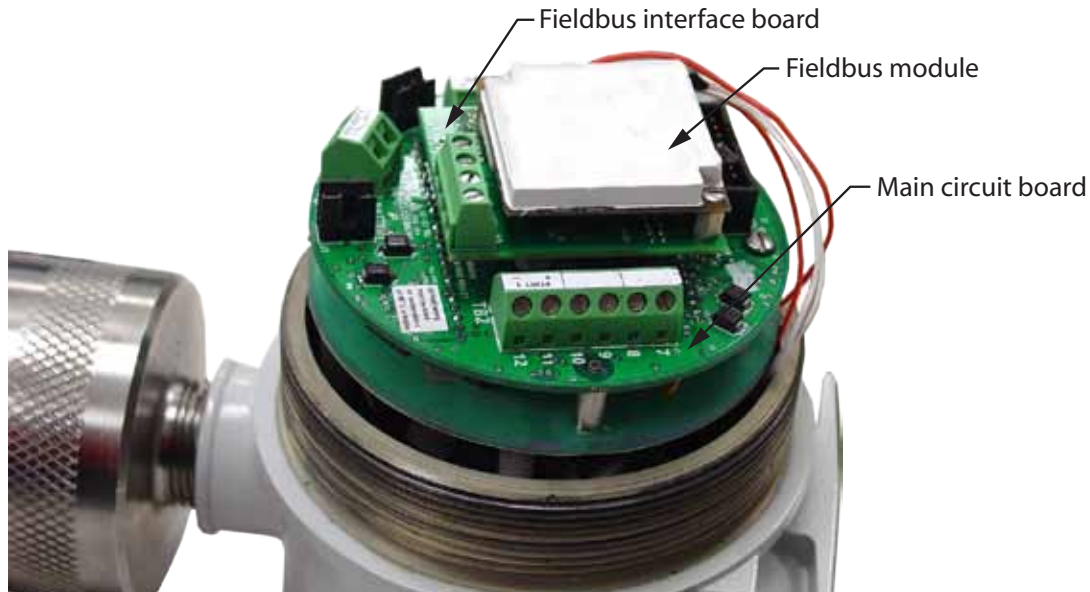

Figure 3.1—Circuit board arrangement

To wire the Scanner 2000 for operation, complete the following field connections:

1. Unscrew and remove the cover from the Scanner 2000 enclosure.
2. Using a small standard blade screwdriver, remove the two #4-40 × 7/8" screws located to the right and left side of the display.
3. Lift the board assembly from the enclosure, making sure it does not contact the enclosure.
4. Route the input or output cable through the conduit opening in the top of the enclosure and connect to the main board, as appropriate.
 - Connect the flowmeter input wiring to TB2. See [Figure 3.5, page 50](#).
 - Connect the process temperature input wiring to TB2. See [Figure 3.6, page 51](#).
 - Connect digital output wiring to TB3. See [Figure 3.7, page 52](#).
 - Connect the RS-485 communications wiring to TB2, if required. See [Figure 3.8, page 53](#).
5. Connect the lithium battery to the J1 connector on the main board. See [Figure 3.3, page 48](#).
6. Connect the FOUNDATION™ fieldbus power cable to TB4 on the fieldbus interface board. See [Figure 3.4, page 49](#).
7. Place the board assembly over the standoffs and fasten with the two #4-40 × 7/8" screws, ensuring that all connector wiring is inside the enclosure and in no position where it may be damaged when the enclosure cover is replaced.
8. Recalibrate the Scanner 2000 (if necessary).

9. If external and internal power supplies were removed, reset the clock to ensure that the time stamps in the log data are accurate. The clock can be reset using the instrument keypad or ModWorX™ Pro software.
10. Replace the enclosure cover.

Grounding Procedures

Typically, FOUNDATION™ fieldbus power circuits are grounded at the point of the fieldbus power supply, and not at the measurement instrument. However, if grounding at the instrument is required, either of two ground terminals can be used:

- An external ground screw is located near the top of the Scanner 2000 housing.
- An internal ground screw is mounted inside the enclosure near the top of the backplate. FOUNDATION™ fieldbus cable can be routed through a conduit opening in the top of the Scanner 2000 enclosure and connected to this ground screw (Figure 3.2).

CAUTION Never connect an instrument signal conductor to a safety ground. Doing so could shut down the entire fieldbus segment.

All intrinsically safe installations should conform to the instructions found in the FOUNDATION™ Fieldbus Application Guide AG 163.

If national or local electrical codes require the enclosure to be grounded, a protective earth grounding conductor may be required. To install a protective earth ground, connect an earth ground conductor to the stainless ground lug near the top of the Scanner 2000 enclosure (also shown in Figure 3.2) or to the internal ground screw, and connect the other end to a ground rod or other suitable system earth ground. The ground lugs will accept wire sizes from 14 AWG solid conductor to 4 AWG stranded conductor.

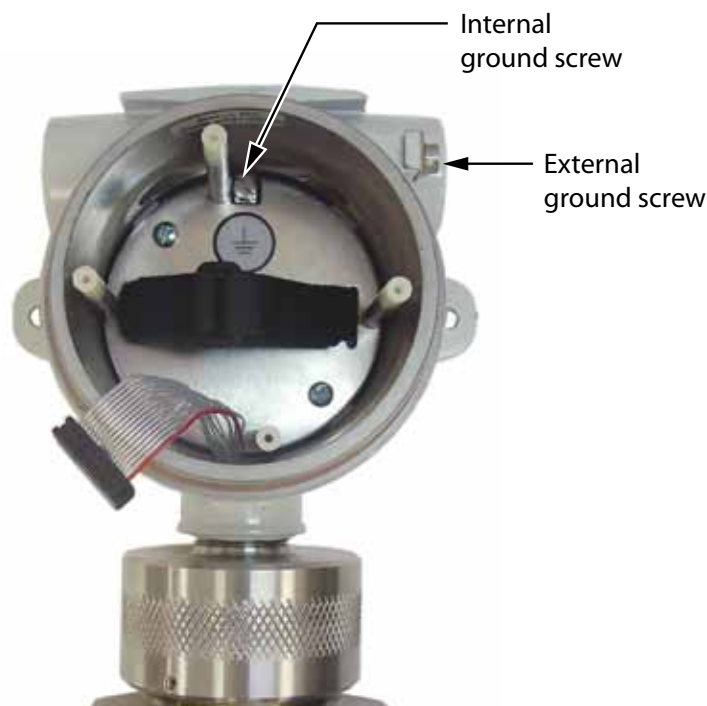

Figure 3.2—Ground screw locations

Power Supply Wiring

Lithium Battery Pack

The Scanner 2000 microEFM is shipped with a lithium battery pack. In FOUNDATION™ fieldbus applications, this battery pack provides backup power. Primary power is provided by a fieldbus power supply.

To supply backup power to the instrument, connect the lithium battery cable to connector J1 on the main circuit assembly (Figure 3.3).

CAUTION Always connect the lithium battery to the main board before connecting fieldbus power to the fieldbus interface board. See also [FOUNDATION™ Fieldbus Power Supply, page 49](#).

In the event that fieldbus power is lost, the lithium battery will help ensure that timekeeping and volume accumulation will not be interrupted. Low-power microprocessor technology enables the Scanner 2000 to operate for an estimated 1 year on a lithium battery pack.

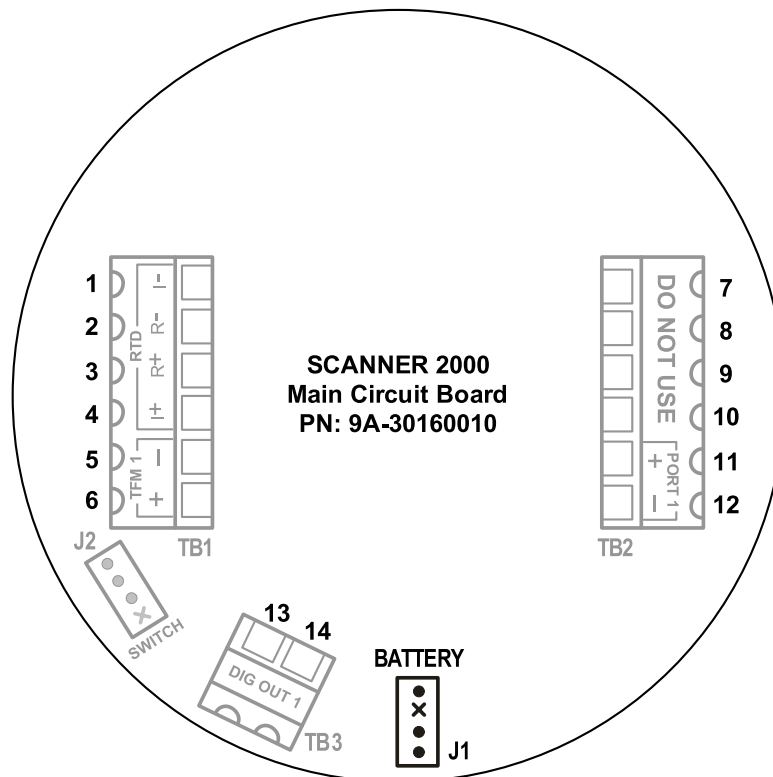

Figure 3.3—Lithium battery pack connection



WARNING: Replace the Scanner 2000 lithium battery only with the Cameron intrinsically safe battery pack, Part No. 9A-30099008. With appropriate measures to prevent damage, the battery pack may be replaced in a hazardous area.

FOUNDATION™ Fieldbus Power Supply

The Scanner 2000 is bus-powered by a FOUNDATION™ fieldbus power supply. A two-conductor cable connects the power supply to the fieldbus interface board inside the Scanner 2000 enclosure. Route the cable through the conduit opening in the top of the enclosure and wire as shown in Figure 3.4. If a terminal housing is in use, fieldbus power may be wired as shown in [Figure A.6, page A-5](#).

Voltage at TB4 should be a minimum of 9V. The electrical safety ratings of the power supply are $U_i = 17.5\text{ V}$, $I_i = 380\text{ mA}$, $C_i = 0$, and $L_i = 10\text{ }\mu\text{H}$.

CAUTION Always connect the lithium battery to the main board before connecting fieldbus power to the fieldbus interface board. See also [Lithium Battery Pack, page 48](#).

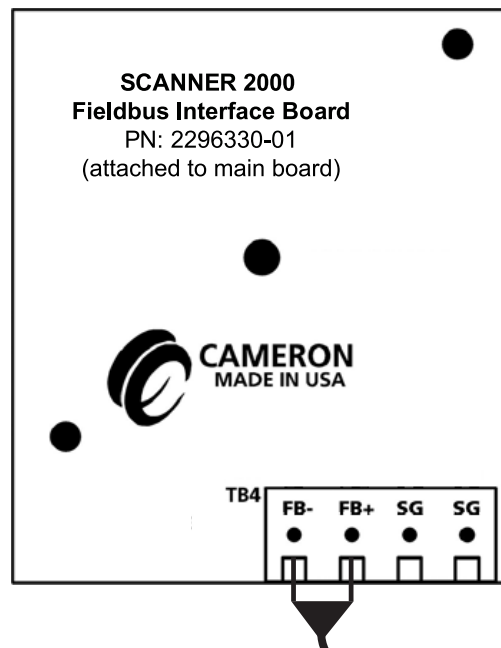

Figure 3.4—FOUNDATION™ fieldbus power supply wiring without terminal housing

Input Wiring

Turbine Flowmeter Input

The Turbine Input on the main circuit board provides the turbine flowmeter input signal generated by a magnetic pickup, enabling the Scanner 2000 to calculate and display instantaneous flow rates and accumulated totals. Wire as shown in Figure 3.5.

Important Use only with ATEX-approved IS-rated pickups. For NuFlo turbine meters, use Part No. 9A-99145007 or 9A-99145008. For Barton 7000 meters, use Part No. 9A-2113-001A-01 or 9A-2113-001A-02. See Spare Parts list, page 81, for descriptions.

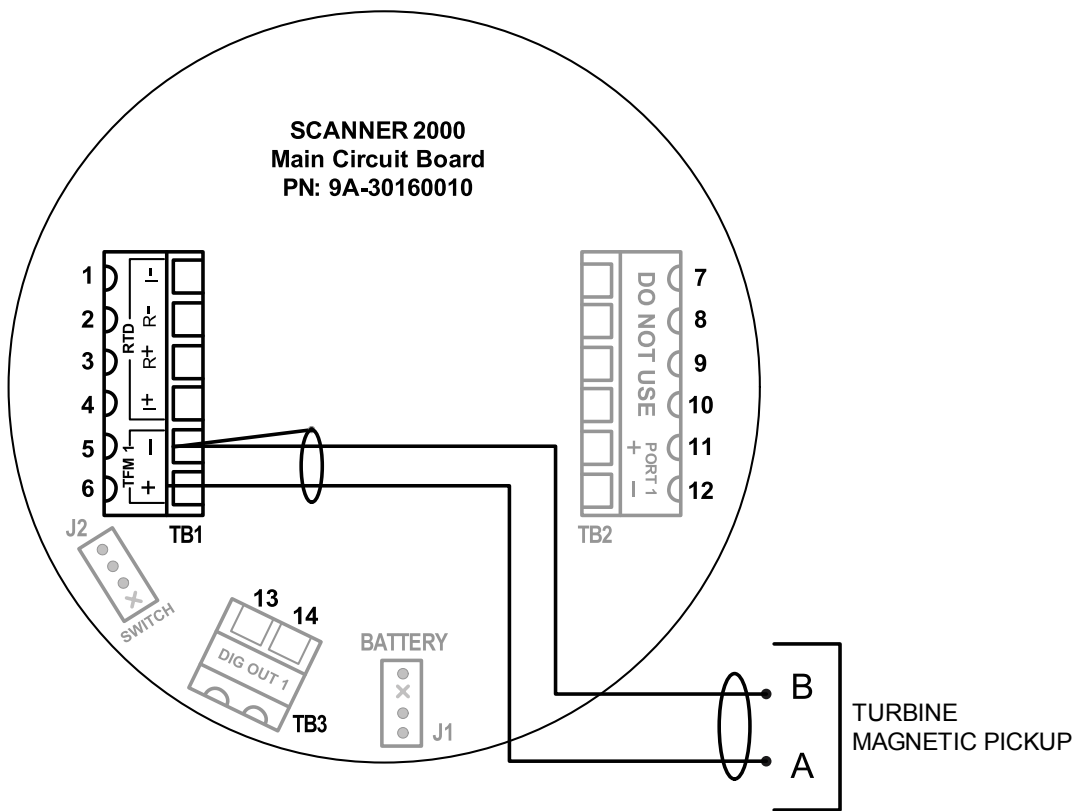

Figure 3.5—Flowmeter input wiring

RTD Input

The RTD is installed in a thermowell downstream of the primary differential pressure source. The location of the thermowell should conform to the relative standard to ensure accurate measurement.

A 4-wire, 100-ohm platinum RTD is recommended for performing orifice gas, compensated liquid, or gas turbine calculations, though a 2- or 3-wire RTD may prove functional. Wire as shown in Figure 3.6. If a terminal housing is in use, RTD inputs may be wired as shown in [Figure A.7, page A-6](#).

Electrical safety ratings for the RTD input are $U_o = 8.1 \text{ V}$, $I_o = 0.272 \text{ A}$, and $P_o = 0.465 \text{ W}$.

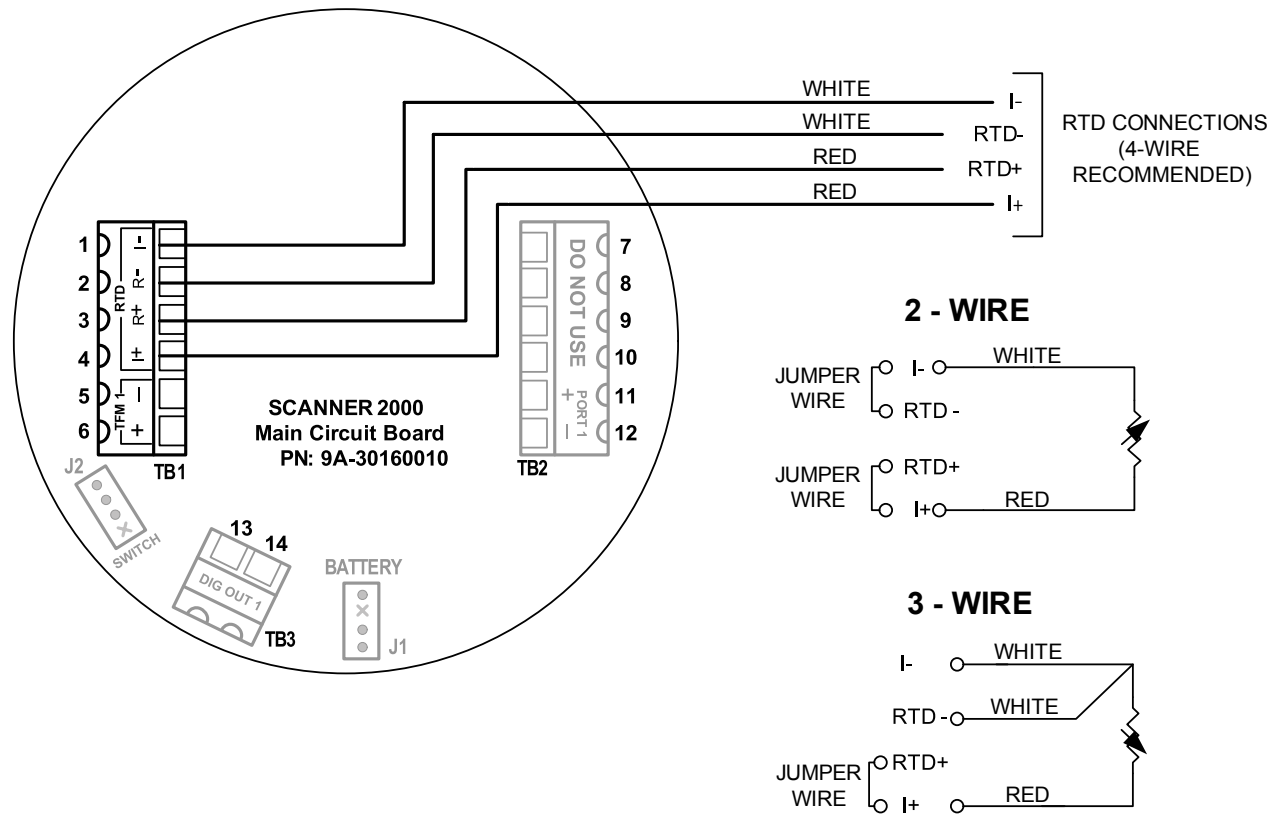

Figure 3.6—Process temperature input wiring without terminal housing

Output Wiring

Digital Output (Pulse or Alarm)

The standard Scanner 2000 supports a solid-state digital output that is configurable as either a pulse output or an alarm output. As a pulse output, the pulse width duration and pulse representation are both configurable. Because the circuit is isolated, it can be used in conjunction with any other feature on the Scanner 2000. A two-conductor cable from the Scanner 2000 to the remote location is required. The electrical safety ratings of the digital output circuit are $U_o = 0$, $U_i = 30$ Vdc, and $I_i = 60$ mA. Maximum frequency is 50 Hz. Wire as shown in Figure 3.7.

For reduced power consumption, turn the digital output feature off when it is not in use.

Note No Modbus to fieldbus conversion is supported for digital output values.

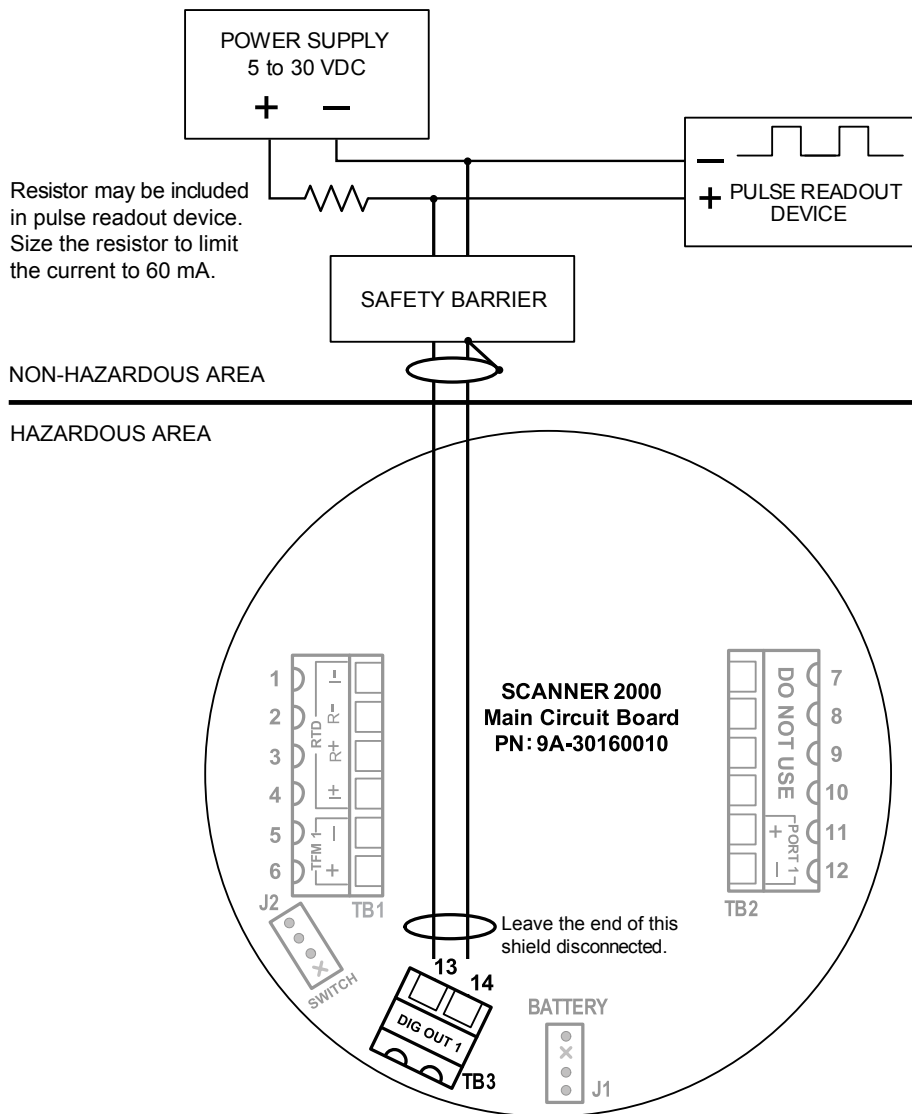

Figure 3.7—Pulse output wiring

RS-485 Output—Computer Connection

The RS-485 output is required for communication with the ModWorX Pro interface software. An RS-232 to RS-485 converter cable (Part No. 9A-101283116) is required for connecting the Scanner 2000 to an RS-232 PC port. Wire as shown in Figure 3.8.

See [External Communications Adapter \(9A-90017004\)](#), page A-1 for detailed instructions for installing an optional external communications adapter.



WARNING: Use the RS-485 output communications connection only when the area is known to be non-hazardous.

Note ModWorX Pro, the Scanner 2000 configuration software, supports two communications ports. However, for fieldbus applications, only Port 1 is configurable.

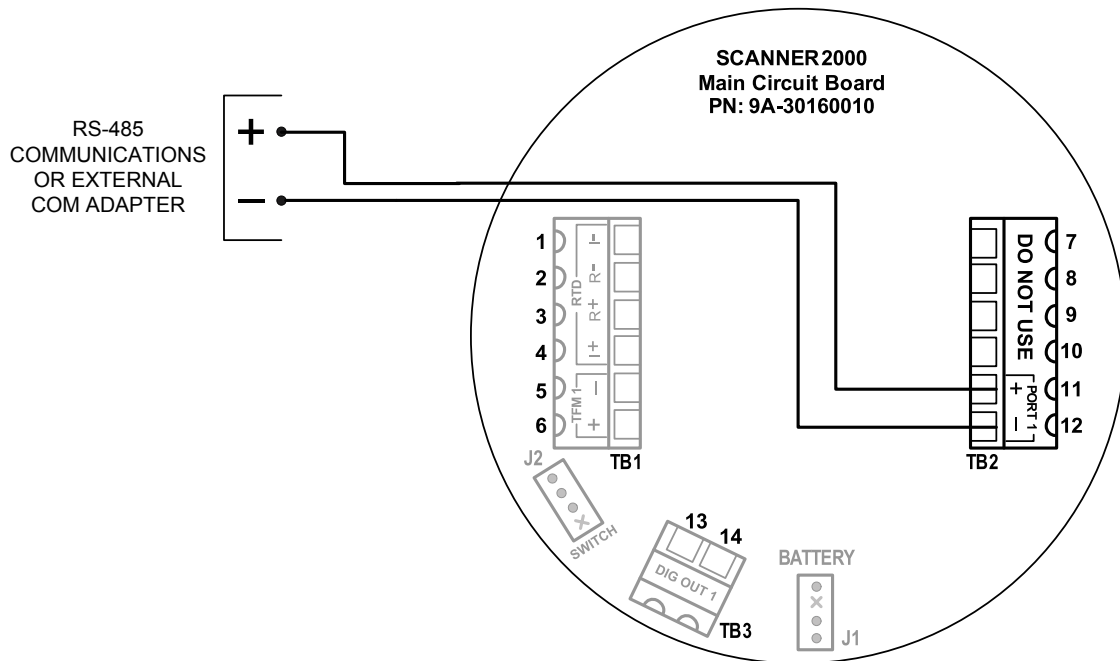

Figure 3.8—RS-485 output

Section 4—Scanner 2000 Configuration and Operation

Note This section discusses the configuration of device inputs and outputs using Modbus communications. Fieldbus communications are configured separately using a configuration tool. See [Section 5—Fieldbus Configuration and Operation](#) for details.

The Scanner 2000's Modbus parameters are configured using ModWorX Pro, a full-featured software application supplied with every Scanner 2000 shipment, providing on-screen tools for configuring hardware and flow calculations, calibrating inputs, and collecting and viewing flow history.

Basic settings can also be changed using the instrument keypad.

Configuring with ModWorX Pro Software

A laptop connection and the ModWorX™ Pro software provided with the Scanner 2000 are required for calibrating and configuring the instrument. The Scanner 2000's natural gas and steam calculations typically require configuration of inputs including differential pressure, static pressure, process temperature, and for AGA-7, a turbine meter input. See the ModWorX Pro user manual for instructions. The manual is available for download from the Cameron Measurement Systems website, and is embedded in the ModWorX Pro software supplied with the instrument.

The Scanner 2000 microEFM supports digital serial communications using EIA-RS-485 hardware with Modicon Modbus® protocol. A Modbus® slave port facilitates communications with a laptop or PC. The baud rate range for the port is 300 to 38.4K. The port is protected from high-voltage transients.

An RS-232 to RS-485 converter is required for connecting the microEFM to a laptop or PC. The converters available from Cameron require no handshaking or external power to operate. See [Section 7—Spare Parts](#) for ordering information; see [Figure 3.8, page 53](#), for wiring instructions.



WARNING: Connect a laptop to the external communications adapter only when the area is known to be non-hazardous.

Configuring with Keypad

From the three-button keypad (Figure 4.1), the user can:

- configure basic parameters such as communications port slave address and baud rate, date and time, contract hour, and plate size
- scroll through display parameters
- view daily flow totals
- save a current total
- check the temperature and system voltage

All other Modbus configuration is performed via the ModWorX™ Pro software.

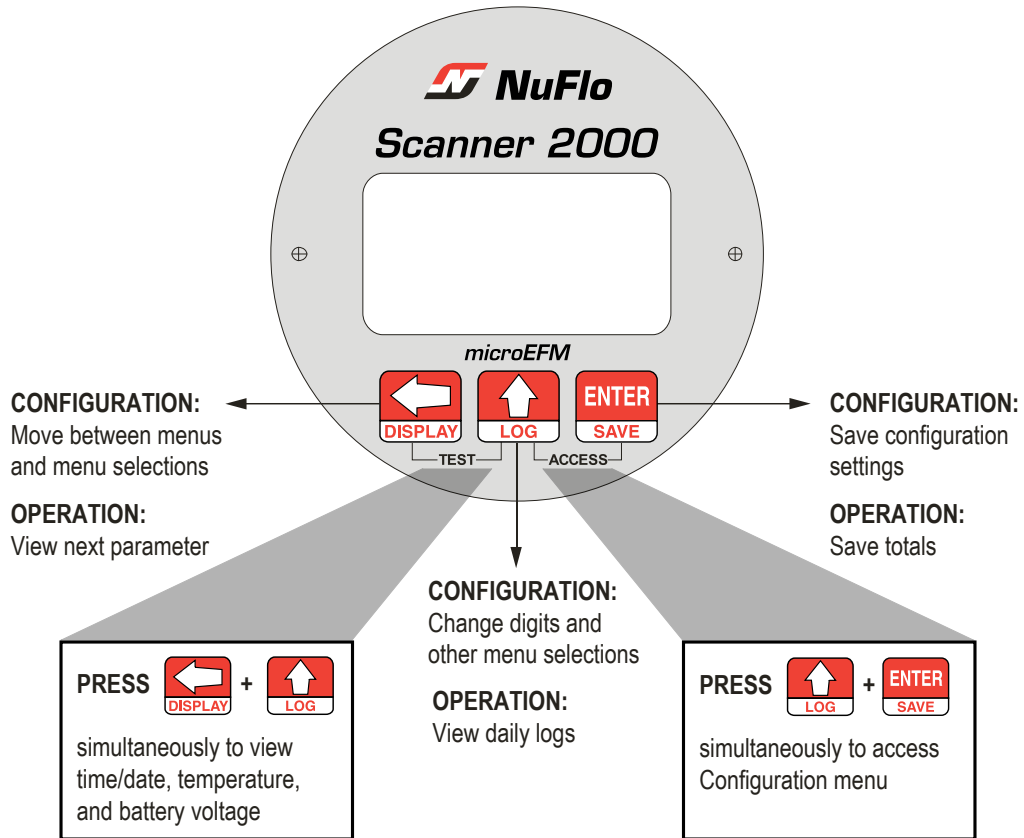







Figure 4.1—Scanner 2000 keypad operation and configuration functions

Press the UP ARROW and ENTER buttons simultaneously to enter the configuration mode. In configuration mode, the parameter to be configured is displayed in the bottom LCD and the setting for that parameter is displayed in the top LCD, as shown on the following pages.

Entering the Slave Address

The slave address is a setting used in Modbus® communications. It is a number that ranges from 1 to 65535, excluding 252 to 255 and 64764, which are reserved. If the Modbus® request message contains the matching address, the device will respond to the request. In network arrangements, the device must have a unique slave address. If Modbus® communications are not used, leave the slave address at the factory setting (1).

To Enter a Port 1 Slave Address:





Enter the Access menu.	Press UP ARROW and ENTER simultaneously.	 + 
Locate the Slave Address setting.	PORT 1 SLAVE ADDRESS will appear in the lower display, and the rightmost digit in the top display will begin blinking.	
Enter the Slave Address. (range: 1 to 65535; excluding 252 to 255 and 64764)	Press UP ARROW until the correct digit is displayed.	
	Then press LEFT ARROW to select the next digit to the left.	
	Repeat using UP and LEFT arrows to enter all remaining digits.	
	Press ENTER.	

The Baud Rate menu prompt will appear immediately following the entry of the slave address. See *Entering the Baud Rate* below for the baud rate entry procedure.

Entering the Baud Rate

The baud rate is the number of bits per second that are on the serial port. This setting must match the setting of the master device polling the Scanner 2000 or the serial port. This only applies to the Modbus® communications; if Modbus® communications are not used, leave the baud rate at the factory setting (9600).

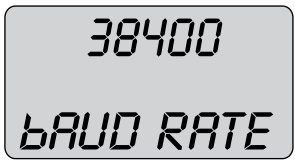











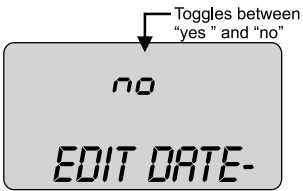

To Enter the Port 1 Baud Rate:

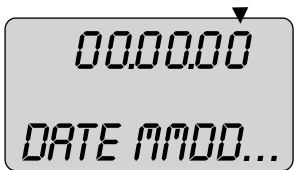
Enter the Access menu.	Press UP ARROW and ENTER simultaneously.	 + 
Locate the Baud Rate setting.	Press ENTER. The words "PORT 1 BAUD RATE" will appear in the lower display.	 
Enter the baud rate.	Press UP ARROW until the correct baud rate is displayed.	
	Press ENTER.	

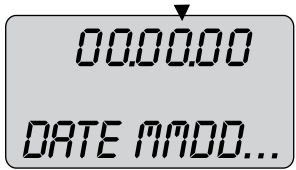
Editing the Date and Time

A user can change the date and time from the keypad.



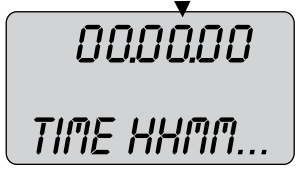





To Edit the Date and Time:

Enter the Access menu.	Press UP ARROW and ENTER simultaneously.	 + 	
Locate the Date and Time setting.	<p>Press ENTER four times. The words "EDIT DATE-TIME" will appear in the lower display and the word "no" or "yes" will begin flashing in the top display (default is "no").</p> <p>Press the UP ARROW to change the setting in the top display to "YES."</p> <p>Press ENTER. "DATE MMDDYY" will appear in the bottom display, and the last two digits, representing the year, will begin flashing.</p>	   	
Enter the month, day and year. The format is MM.DD.YY.	<p>To change the year, press the UP ARROW, repeatedly if necessary, until the last two digits of the year are displayed (for example, for 2006, enter "06").</p> <p>To change the day, press the LEFT ARROW. The two middle digits will begin flashing. Press the UP arrow until the correct day is displayed.</p> <p>Repeat the previous step to select the first two digits and enter the month.</p>	   	
Enter the month, day and year. The format is MM.DD.YY. (cont'd)	<p>Press ENTER. "TIME HHMMSS" will appear in the bottom display, and the last two digits, representing seconds, will begin flashing.</p>		
Enter the time (hour, minute, and seconds). The format is HH.MM.SS.	<p>To change the seconds displayed, press the UP ARROW, repeatedly if necessary, until the correct time (seconds) is displayed.</p> <p>To change the minutes displayed, press the LEFT ARROW. The middle two digits will begin flashing. Press the UP ARROW until the correct time (minutes) is displayed.</p> <p>Repeat the previous step to select the first two digits and enter the hour (military time: Ex. 1 p.m. = 13).</p> <p>Press ENTER. "CONTRACT HOUR" will appear in the bottom display.</p>	  	 

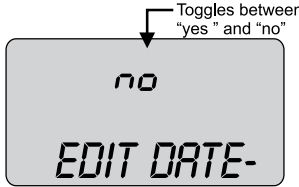
Editing the Contract Hour

A user can set the contract hour from the keypad. The contract hour determines the exact time the daily flow is logged, and is represented by a four-digit number displayed in military time.

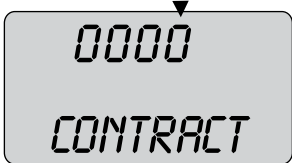









To Edit the Contract Hour:

Enter the Access menu.	Press UP ARROW and ENTER simultaneously.	 + 
Locate the Contract Hour setting.	<p>Press ENTER four times. The words "EDIT DATE-TIME" will appear in the lower display and the word "no" or "yes" will begin flashing in the top display (default is "no").</p> <p>Press the UP ARROW to change the setting in the top display to "YES."</p> <p>Press ENTER. "DATE MMDDYY" will appear in the bottom display.</p> <p>Press ENTER a second time. "CONTRACT HOUR" will appear in the bottom display.</p>	    
Enter the contract hour.	<p>Press the UP ARROW, repeatedly if necessary, to change the contract hour. Each press of the button will increment the time by 1 hour.</p> <p>Press ENTER. "SAVING" will appear in the bottom display.</p>	  

Editing the Plate Size

When the differential pressure producer in a Scanner 2000 installation is an orifice meter and security controls allow, a user can change the size of the orifice plate from the keypad. The plate size is displayed in inches. If “Strict API compliance” is enabled in the Security menu of the ModWorX™ Pro software, this parameter can be configured only from the ModWorX™ Pro interface, which allows the operator to put the instrument into maintenance mode (locked inputs) while the plate change is in process. See Section 3 of the ModWorX™ Pro Software User Manual, Part No. 9A-30165025, for details.

To Edit the Plate Size:

Enter the Access menu.	Press UP ARROW and ENTER simultaneously.	 + 
Locate the Plate Size setting.	<p>Press ENTER five times. The words “CHANGE PLATE” will appear in the lower display and the word “no” or “yes” will begin flashing in the top display (default is “no”).</p> <p>Press the UP ARROW to change the setting in the top display to “YES.”</p> <p>Press ENTER. “PLATE SIZE - INCHES” will appear in the bottom display.</p>	   
Enter the new plate size.	<p>Press UP ARROW until the correct digit is displayed.</p> <p>Then press LEFT ARROW to select the next digit to the left.</p> <p>Repeat using UP and LEFT arrows to enter all remaining digits.</p> <p>Press ENTER.</p>	   

Navigating the Display

Up to 12 parameters can be configured for display on the LCD using ModWorX™ Pro software, and up to 99 consecutive daily logs can be viewed using the keypad..

Viewing Real-Time Measurements

During normal operation, the LCD displays the selected parameters in a continuous scroll. To stop the scrolling action and manually advance the parameter displayed on the screen, remove the cover of the instrument and press the LEFT ARROW button on the keypad (Figure 4.1, page 56). The parameter selected for display will appear as shown in Figure 4.2.

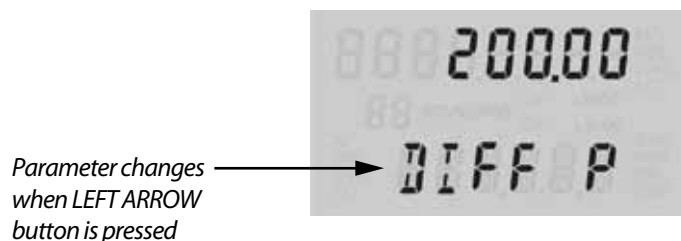

Figure 4.2—LCD display of real-time measurements

Viewing Daily and Hourly Logs

Pressing the Log button (Figure 4.1, page 56) changes the LCD display mode from normal operation (scrolling) to a daily log view mode. The two-digit flashing number or “log index” on the left side of the LCD represents the number of days that have passed since the log was saved. The user can increment or decrement the number by clicking the UP ARROW or DOWN ARROW buttons. For example, “01” will display the last daily log saved. An index of “05” will display the daily log saved 5 days prior.

By default, the top display shows flow volume; however, the user can configure the display to show any of the 16 parameters available using ModWorX™ Pro software. The bottom display shows the date. The entire log archive—up to 768 daily logs, 2304 adjustable interval logs, and 1152 event/alarm logs— can be viewed using ModWorX™ Pro software.

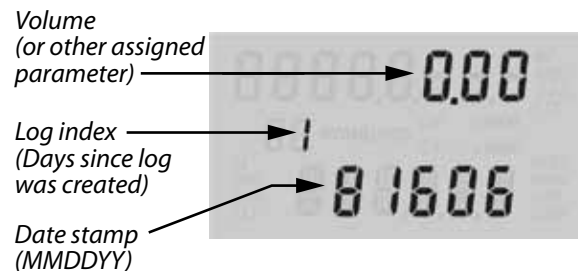

Figure 4.3—LCD display of daily logs

Password-Protected Security

A keypad security access code prevents unauthorized personnel from altering the calibration or accumulated volume data in the instrument. The security feature may be disabled if this protection is not required.

Password-protected security access is enabled using the ModWorX™ Pro software. When this feature is enabled, the user will be prompted for a four-digit password each time he attempts to enter a menu from the keypad (Figure 4.4). The ModWorX™ Pro software is required for establishing or changing the password.



Figure 4.4—LCD display of security password menu

Section 5—Fieldbus Configuration and Operation

Overview

At the core of the Scanner 2000 is an electronics package that measures and computes standard volumes of gas, steam, petroleum liquids, and generic liquids with a high degree of accuracy and with very low power consumption. These electronics communicate via RTU Modbus.

The Scanner 2000 for FOUNDATION Fieldbus expands those capabilities to allow communication with devices on a fieldbus network using FOUNDATION™ fieldbus H1 protocol. In addition to its native Modbus communications, the Scanner 2000 publishes values for four process variables to a FOUNDATION™ fieldbus network using an integrated fieldbus module.

The process variable values are written to a transducer block within the fieldbus module. When the process variables are mapped to analog input blocks within the fieldbus module, those variable inputs are published to the network and made available for development of process control strategies.

Device Description

The device description (DD) is a text file that precisely describes Scanner 2000 device capabilities for use by the host system. It defines the parameters that are available for building control loops, establishes the arrangement of parameters in a menu structure, and determines how parameters are related to one another.

DD files are downloaded to the host in preparation for configuring the device. These files are available on the Fieldbus Foundation™ website (www.fieldbus.org) and the Cameron website (www.c-a-m.com/flo). There are two device description files and one capabilities file (CFF). All three files must be downloaded in order for the host to identify the Scanner 2000 as a networked device.

Note Device description files are available in both DD4 and DD5 formats. Please confirm the compatibility of your host system before selecting a version for download. DD4 files have extensions .ffo and .sym, and DD5 files have extensions .ff5 and .sy5.

Block Descriptions

The Scanner 2000 fieldbus module contains six blocks:

- a resource block
- a transducer block
- 4 analog input function blocks

Each block is identified by a tag name. The user can change the tag name, however, the name must be unique in the system. A tag name can contain up to 32 characters.

Block Modes

Each block has a block mode (MODE_BLK) parameter that determines the block's mode of operation. Four elements make up the block mode: Target, Actual, Permitted and Normal.

- The Target setting is the desired operating mode.
- The Actual setting is the current mode of operation and is read-only. An Actual mode that differs from the Target mode should be investigated. See the BLOCK_ERR parameter for more information.

- The Permitted setting determines the mode options that may be selected as the Target mode.
- The Normal setting is a reminder of the normal operating mode that the block should be returned to in the event that the mode is changed, either by a user or as the result of operating conditions.

Typically, blocks are placed either in Auto mode or Out of Service (OOS) mode. For the Scanner 2000, the standard mode of operation for the resource and transducer blocks is Auto and this setting is entered as the “target” mode. When the mode is changed to OOS, the blocks become inoperable. Some online configuration changes to the transducer block can be made only when the block is in OOS mode.

Resource Block

The resource block can be used to check hardware status, to disable all function blocks in the Scanner 2000, and to restart the control strategy execution. It has no input or output parameters and cannot be linked to another block.

Important **The resource block mode controls the mode of all other blocks. When the resource mode is OOS, the modes of all other blocks are placed in OOS mode, effectively disabling the entire device. Auto is the normal operating mode of the resource block.**

The Resource State parameter shows the status of the hardware. If the hardware is working as designed, the status is displayed as “online.” If the resource block is placed in OOS mode, the status will be “Standby.” If a hardware failure occurs, the resource state will be “Failure.”

By selecting the Restart parameter, a user can restart the control strategy. Additional selections allow a restart without changing the configuration, a restart after resetting parameters to default values, or a reset of the CPU. During normal operation, this parameter is displayed as “Run.”

Transducer Block

The transducer block is an interface between the Scanner 2000 sensor and the device’s analog input function blocks. It is responsible for reading the measurements of process variables such as pressure, temperature, or flow rate from Modbus registers and making the variables available for selection as analog inputs in a fieldbus network.

Like the resource block, the transducer block has no input or output parameters and cannot be linked to another block. However the transducer block does interface with function blocks over input/output hardware channels to enable the use of process variable values in process control strategies. Additionally, the transducer block contains parameters that can be used to provide various Modbus data such as input measurements, flow volumes, and other Modbus calculations to a fieldbus host.

Automatic is the normal operating mode of the transducer block. In some cases, the transducer block must be placed in OOS mode to allow a configuration change to be made without affecting ongoing processes.

Analog Input (AI) Function Blocks

The analog input (AI) function blocks access a process variable measurement through a hardware channel from a transducer block. Various types of function blocks may be linked together to create control strategies. The input block may process the input value before it makes it available to other function blocks for output.

At a minimum, the user must enter the following parameter settings when configuring an AI block:

- mode parameter (target)
- assignment of AI block to a channel (defines the process variable measurement that will be used as input to the AI block)
- linearization method
- value range for input and output values
- engineering unit for output values, if required

An AI function block is typically set in Auto mode and never changed.

The output value from the AI block is in engineering units and contains a status parameter indicating the quality of the measurement.

Device Identification

When the Scanner 2000 is connected to a fieldbus network, it is typically detected automatically by the host system. The host can use any of the following methods to identify the Scanner 2000:

- Device ID
- Physical Device (PD) tag
- Node address

Consult your host manual or configuration tool manual for information on accessing this information.

Device ID

Each Scanner 2000 has a 32-character hardware identifier that is unique to each unit. This address is set by Cameron, stored in the firmware for the device, and cannot be changed. The Scanner 2000 Device ID is 43414DXXXX_FBK_YYY where XXXX is the device type indicator, and YYY is the serial number for the fieldbus module. The first six digits is Cameron's manufacturer identification number.

Physical Device (PD) Tag

The Scanner 2000 is assigned a default PD tag name at the factory. This tag name uses the following format: SCANNER2000FF_XX_FBK_YYY where XX is a Cameron-assigned device identifier and YYY is the serial number for the fieldbus module.

The user can change this name when configuring the fieldbus network. When choosing a PD_TAG name, keep the following guidelines in mind:

- Choose a tag name that is unique among devices in a plant or among fieldbus segments.
- Choose a tag name that allows easy identification of the device in configuration software.
- The PD tag name can contain up to 32 characters.
- The tag name should match the name used in the network diagram document.

Node Address

When a Scanner 2000 leaves the factory, it has a temporary default node address of 248. During configuration, the user will assign a permanent address in the range of 16 to 247. The permanent node address must be unique to the fieldbus segment on which the device is installed.

IMPORTANT If multiple devices with the same default node address are being installed and the configuration tool uses the node address to identify a device, the host or configuration tool may not detect all devices at the first attempt. In this case, the user should assign a permanent node address to the detected device, and then scan the segment to detect each new device, repeating the process until all devices have been assigned permanent (unique) node addresses.

Configuring Fieldbus Communications

Scanner 2000 fieldbus communications can be configured with any configuration tool that supports device description methods.

Configuration changes can be made online (written to the device) or offline (written to the database only). To avoid unexpected changes to process controls, online changes are often limited to value changes after the Scanner 2000 is in operation. Typically, the initial Scanner 2000 configuration is performed offline, and then once the configuration is complete, the settings are downloaded from the database to the device.

Fieldbus communications can be configured in three main steps:

1. setting up the configuration tool
2. configuring the AI blocks
3. downloading the network configuration to the device

Setup of the configuration tool and download of the network configuration to the Scanner 2000 will vary with product manufacturers. See the host manual or the configuration tool manual for detailed instructions.

CAUTION If installing multiple devices, verify that each device has a unique node address. If two or more units have the same node address, the configuration software will not detect more than one unit.

Communications Test

Before configuring the AI blocks, verify that the Scanner 2000 is communicating with the fieldbus network by checking the following parameters:

1. Check the Comm State parameter in the transducer block. If the device is communicating properly, a confirmation message will appear. If the device is not communicating, an error message will be displayed.
2. Verify that the process variable values (primary value, secondary value, etc.) in the transducer block are changing.

Configuring AI Blocks

Four parameters are required to configure each AI Block: Channel, L_Type, XD Scale, and Out_Scale.

1. Verify that the mode (Target) of the AI block and of the resource block is set to Out of Service (OOS).
2. Map a channel to the AI block input by selecting the channel that corresponds with the process variable desired. Typically, a different channel (process variable) is assigned to each AI block. However, a channel can be assigned to multiple AI blocks, if a process variable is being used for more than one purpose (for example, to close a valve and to log the value of the variable for historical reference).

3. Verify that the engineering units displayed by the XD-SCALE>UNITS_INDEX parameter match the units displayed in the transducer block (as configured in ModWorX Pro and read from Modbus registers). If the units displayed in the transducer block and the AI block differ, change the AI block units. If the units do not match, an error message will be generated when the block is executed.
4. Set the L_Type (linearization type) parameter to one of the following selections: direct, indirect, or indirect square root. This setting determines if the values passed by the transducer block to the AI block may be used directly (Direct) or if the value is in different units and must be converted linearly (Indirect Linear) using the input range defined by XD_SCALE and the associated output range (OUT_SCALE).
 - a. Select direct when the desired output will be the same as the sensor measurement (static pressure, differential pressure, process temperature, or flow rate). This setting is recommended for most Scanner 2000 applications. Because units are typically configured in ModWorX in accordance with the units required for process control, there is little need for input scaling which is achieved through indirect linearization.
 - b. Select indirect when the desired output is a calculated measurement based on the sensor measurement (e.g. a pressure measurement is made to determine level in a tank). The relationship between the sensor measurement and the calculated measurement will be linear. This linearization is not normally required in Scanner 2000 applications, due to the Scanner's Modbus-based unit configuration capabilities, as discussed in step 4a.
 - c. A third linearization type called indirect square root is available for selection, but is not recommended for Scanner 2000 applications.
5. Set the XD-SCALE parameter. This setting defines the input values from the transducer block (input range of sensor) that correspond to 0% and 100% values in AI function block calculations. When the desired output is the measured variable (L_TYPE is set to direct), set the XD_SCALE to represent the operating range of the sensor. When an inferred measurement is made based on the sensor measurement (L-TYPE is set to indirect), set the XD_SCALE to represent the operating range that the sensor will see in the process.
6. Set the OUT-SCALE settings in accordance with the XD-SCALE 0 and 100% points. This setting defines the output values corresponding to 0% and 100% values in the calculation inside the AI function blocks.
 - a. If scaling is not required, enter the same values that were entered for the XD-SCALE parameter in the EU_100 and EU_0 subparameter fields.
 - b. If the measured or calculated value must be scaled to provide the desired output (and the L-TYPE parameter is set to indirect), enter the values that correspond with 0% and 100% of the output range in the EU_0 and EU_100 subparameter fields, and enter the appropriate output unit in the UNITS_INDEX field.
7. Configure alarms, if desired.
 - a. Set value limits for high (HI_LIM) alarms.
 - b. Set value limits for high high (HI_HI_LIM) alarms.
 - c. Set value limits for low (LO_LIM) alarms.
 - d. Set value limits for low low (LO_LO_LIM) alarms.

- e. Set a priority level for each alarm, as appropriate, by selecting a numeric code from the five priority levels supported:
 - 0 = alarm not used
 - 1 = alarm is recognized by the network, but is not reported to the user
 - 2 = alarm is reported to the user
 - 3-7 = advisory alarms of increasing priority, with 7 being the highest priority
 - 8-15 = critical alarms of increasing priority with 15 being the highest priority
8. Repeat steps 1 to 7 for each of the other AI blocks, as required.
9. Change the mode (Target) of each AI block to Auto.

Control Loop Design

When the AI blocks have been configured, the user may proceed with linking function blocks to build a process control loop and configuring scheduling of block executions. These activities are not specific to the Scanner 2000 and are outside the scope of this manual. See the host manual or configuration tool manual for assistance.

NOTE The maximum time required to execute a Scanner 2000 AI block is 30 ms.

When control loops are configured, the network configuration must be downloaded to the network. See the host manual or the configuration tool manual for instructions.

Fieldbus Operations

The FOUNDATION™ Fieldbus Protocol Manual for Scanner 2000 provides a list of the parameters supported by the Scanner 2000 fieldbus module. Neither resource blocks nor transducer blocks can be linked to other function blocks to build a control strategy. However, process variable parameters from the transducer block can be mapped to an AI block and used as an input for the AI block. None of the other transducer block parameters are available for use as AI block inputs.

Engineering Units

The Engineering units used for process variables are written to Modbus registers during the configuration of the Scanner 2000 using the ModWorX Pro configuration software provided with the Scanner 2000. The units are then converted to fieldbus code by the fieldbus module.

Since the preconfigured units are being transferred to the fieldbus module, rather than the module having to convert raw inputs to a desired unit before publishing the values to the network, there is little need for scaling process values with a fieldbus configuration tool.

NOTE FOUNDATION™ fieldbus supports combined units for many rate measurements. However Scanner 2000 does not support these combined unit displays. Instead, flow rate is represented as two separate measurements (volume and time) that are displayed as two parameters in the host interface software.

Status

Every measured or processed parameter in the transducer block and AI blocks is represented by two elements in the configuration tool: a value and a status. Process variable status descriptions and values are continually displayed within the analog input block section of the configuration tool.

Status can indicate a hardware, communication, or other fault. Each status is made up of three forms of intelligence: quality, sub-quality, and limit condition.

- Quality indicates status in general terms: good, uncertain, or bad.
- Sub-Quality provides additional information to help explain the problem. For example, if the quality status is “bad,” the sub-quality status may indicate “device failure” or configuration error.”
- Limit Condition identifies if there is a limit placed on the value or not. For example, “limited high” indicates that value has reached its upper limit, and “constant” means the value cannot go higher or lower. Typically, the limit condition is set to “none.”

Fieldbus Troubleshooting

There are many parameters in the resource, transducer and analog input blocks that can assist users in troubleshooting operations problems. Some of the most commonly used parameters are described below.

A change in the status of a measured or processed parameter may be the earliest indication of a problem. See [Status, page 68](#), for details.

General Errors

Block Error

The block mode (MODE_BLK) parameter exists in all blocks and can indicate a potential problem. Check the Target mode and the Actual mode. If they do not match, there is likely a problem. Check the block error (BLOCK_ERR) parameter for possible causes.

Remember to check the mode of the resource block. If it is in OOS mode, all other blocks will automatically be placed in OOS mode as well.

The block error parameter provides an overview of hardware and software errors. It is effective in tracing a wide variety of errors including block configuration errors, link configuration errors, fault state forced, need for maintenance, input/output/memory failure, and lost data.

If the error is defined as a block configuration error, check that all parameters in the block with an invalid default value have been configured. Check that all limit parameters are within the range established by the scaling parameter. Changing an engineering unit can cause a configuration error if it causes some values to go out of range.

Resource State

Another good early checkpoint is in the resource block. The Resource State (RS_STATE) parameter shows the status of the control strategy. If the Resource State is Failure, a memory failure or other hardware failure has been detected.

Transducer Block Error

The transducer error (XD_ERROR) parameter reports errors that are unique to the Scanner 2000. It displays only one error at a time, and when multiple errors are present, it displays only the highest priority error. For a list of common transducer errors, their descriptions, and tips for identifying the cause, see the FOUNDATION™ Fieldbus Protocol Manual for Scanner 2000.

Communication Faults

When a communication fault occurs, use the configuration tool to determine if it affects a single device or the entire network. If a device fails to communicate, it will be removed from the live list displayed in the configuration tool.

Common checkpoints include:

- Check continuity of connections. Measure resistances to eliminate a short circuit as the cause.
- Confirm voltage levels. If the supply voltage at the device is below 9 VDC, the device may not operate normally. Possible causes may include
 - voltage drop due to poor connections in terminal housing or at the device
 - too many devices on a network
- Check for noise sources.

Section 6—Scanner 2000 Maintenance

The ATEX-certified Scanner 2000 for FOUNDATION™ Fieldbus is fully compliant with European ATEX Directive 94/9/EC. User repairs are to be limited to the battery and component replacement procedures described in this manual. All other repairs are to be carried out by the manufacturer, or its approved agents, in accordance with the applicable code of practice (e.g. IEC 60079-19).

The Scanner 2000 is engineered to provide years of dependable service with minimal maintenance. Batteries require periodic replacement, and battery life depends on battery power usage, the configuration settings of the Scanner 2000, and ambient temperature conditions.

All Modbus configuration settings are stored in nonvolatile memory; therefore, configuration settings will not be lost in the event of battery failure.

The main board, keypad, fieldbus interface board, or fieldbus module may also require replacement over the life of the instrument. Replacement procedures are provided in this section.



WARNING: Before servicing the Scanner 2000, disconnect all power sources/signal sources or verify that the atmosphere is free of hazardous gases.

Lithium Battery Pack Replacement



WARNING: Replace the Scanner 2000 lithium battery only with the Cameron intrinsically safe battery pack, Part No. 9A-30099008. With appropriate measures to prevent damage, the battery pack may be replaced in a hazardous area.

The lithium battery supplied with the Scanner 2000 has a typical life expectancy of 1 year when used as a primary power source. Batteries will last considerably longer when used as a backup power source, secondary to the fieldbus-supplied power.



WARNING: The lithium battery pack that powers the Scanner 2000 is a sealed unit; however, should a lithium battery develop a leak, toxic fumes could escape upon opening the enclosure. Ensure that the instrument is in a well-ventilated area before opening the enclosure to avoid breathing fumes trapped inside the enclosure. Exercise caution in handling and disposing of spent or damaged battery packs. See additional information in [Appendix B—Lithium Battery Information](#).

Important Press the ENTER/SAVE key on the keypad before replacing the lithium battery pack to save accumulated grand totals and previous day totals for flow run and turbine volume, energy, and mass to nonvolatile memory. Once the battery pack is replaced and power is restored to the unit, the last saved accumulated totals will be displayed in the LCD. The instrument clock will need to be reset following battery replacement. All configuration and calibration settings are automatically saved to non-volatile memory and are not affected by a temporary loss of battery power.

The lithium battery pack is secured inside the enclosure by a Velcro strap and connected to a connector (J1) near the top of the main board.

To replace a lithium battery pack, perform the following steps:

1. Unscrew the cover from the enclosure and set it aside.
2. Using a small standard blade screwdriver, remove the two #4-40 × 7/8" screws located to the right and left side of the display (Figure 6.1).
3. Lift the board assembly from the enclosure, making sure it does not contact the enclosure.
4. Disconnect the fieldbus input cable from TB4 of the fieldbus interconnect board. If the bus is powered, take precautions to prevent the fieldbus conductor wires from touching and short-circuiting the network.
5. Loosen the Velcro strap, disconnect the battery from the J1 connector on the main board, and remove the spent battery pack from the enclosure (Figure 6.1).

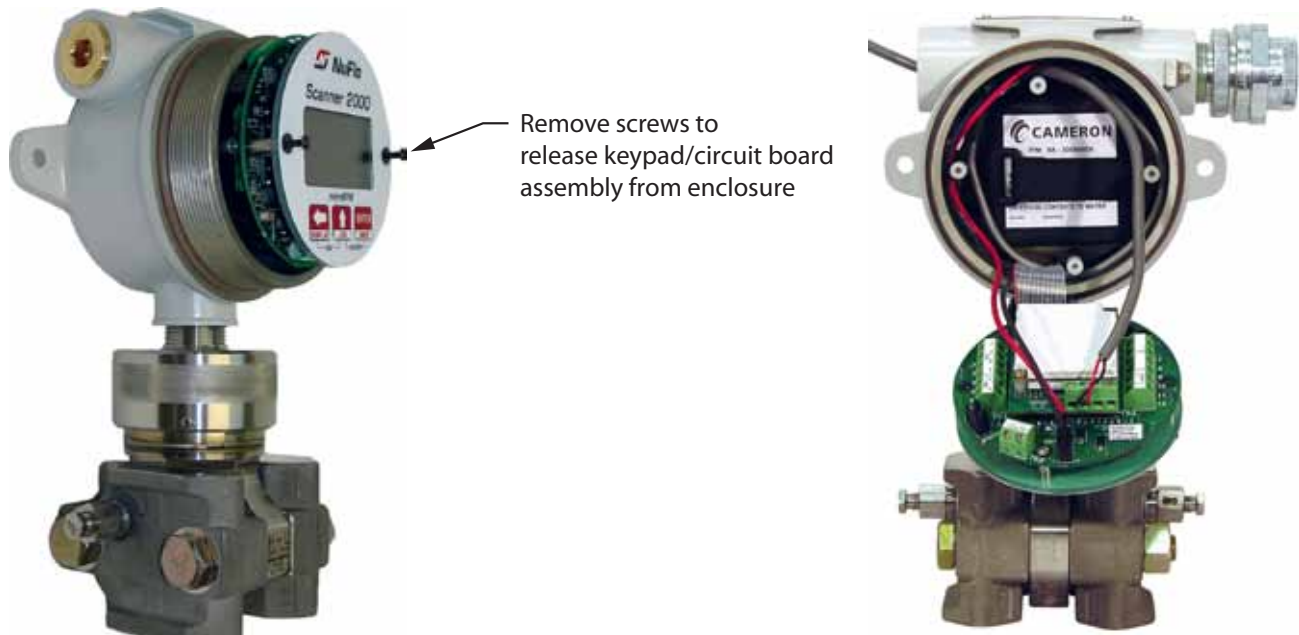

Figure 6.1—Removal of the battery pack from the enclosure

6. Install the new battery pack in the enclosure in the same position as the original battery pack, and secure the Velcro tightly around it.
7. Connect the replacement battery pack to the J1 connector.
8. Reconnect the fieldbus input cable to terminal block TB4 on the fieldbus interface board.
9. Place the board assembly over the standoffs and fasten with the two #4-40 × 7/8" screws, ensuring that all connector wiring is inside the enclosure.
10. Replace the enclosure cover.

Important An interruption of power to the Scanner 2000 will cause the internal clock time to be incorrect. Reset the time using the keypad on the switchplate or the ModWorX™ Pro software. See [Editing the Date and Time, page 58](#), for details.

Board Replacement

The Scanner 2000 electronic circuitry includes three boards (Figure 6.2). The main board (on bottom of the board stack when the assembly is removed from the enclosure) is attached to a smaller fieldbus interface board, which is in turn attached to a white potted fieldbus module. Only the main board and fieldbus interface board have input/output field connections.

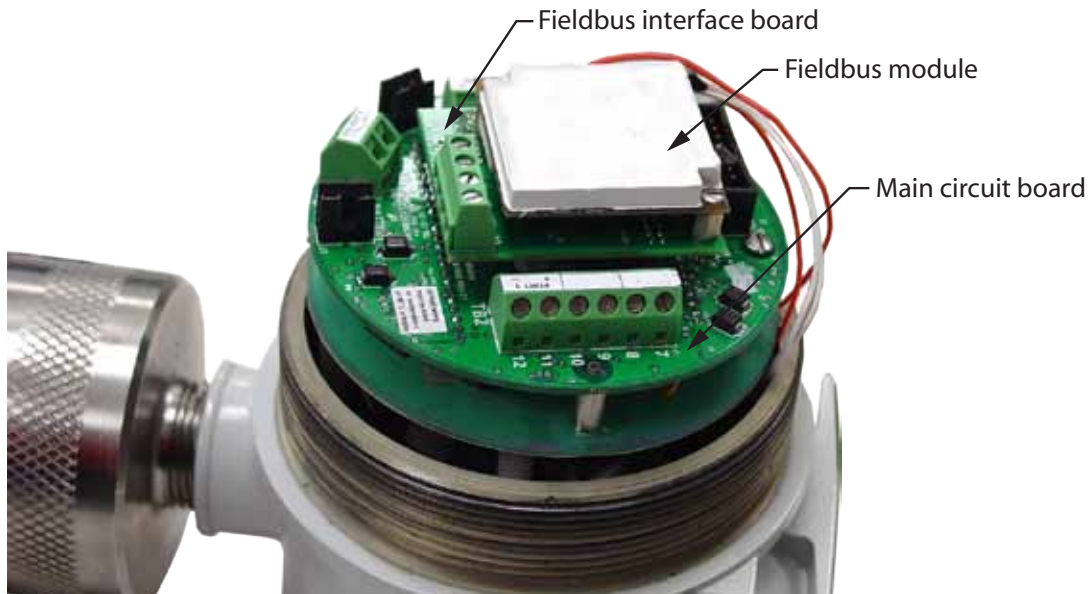

Figure 6.2—Circuit board arrangement

Main Board

Important Static electricity can damage a circuit board. Handle new boards only by their edges, and use proper anti-static techniques (such as wearing anti-static wrist strap or touching metal to establish an earth ground) prior to handling a board.

Important If possible, download the configuration settings and all archive logs before replacing the circuit board. Press the ENTER/SAVE key on the keypad before disconnecting the battery to save accumulated flow run and turbine volume totals (grand total and current day total), and energy and mass totals to memory.

Important The interface board is attached securely to the main board by a standoff that is not visible when all three boards are assembled. The interface board cannot be removed from the main board without first removing the white potted module to access the standoff.

To replace the main board, perform the following steps:

1. Unscrew the cover from the enclosure and set it aside.
2. Using a small standard blade screwdriver, remove the two #4-40 × 7/8" screws located to the right and left side of the display (Figure 6.1, page 72).

3. Lift the board assembly from the enclosure, taking precautions to avoid straining the sensor ribbon cable connection.
4. Record the locations of all cable connections to the main board.
5. Disconnect the fieldbus input cable from terminal block TB4 on the fieldbus interface board (Figure 6.3).
6. Unplug the battery cable from connector J1 on the main board (Figure 6.3).
7. Using a small standard blade screwdriver, remove all wiring from terminal blocks TB1, TB2, and TB3, ensuring that all wiring that is connected to powered circuits is insulated with tape.



Figure 6.3—Removal of the battery cable and fieldbus interface board cable

8. Remove the two screws that attach the white potted fieldbus module to the fieldbus interface board, and remove the module from the interface board (Figure 6.4).
9. The interface board is firmly connected to the main board with a plastic standoff. Using small pliers, squeeze the two halves of the standoff together while applying firm pressure to separate the interface board from the main board. Proceed with care to avoid bending the pins on the interface board. With the fieldbus module and the fieldbus interface removed, the main board will be in full view (Figure 6.5, page 75).



Figure 6.4—Removal of white potted fieldbus module

10. Disconnect the sensor ribbon cable from the J5 connector on the main board as follows:
 - a. Lift the latch from the black clip securing the ribbon cable (Figure 6.6).
 - b. When the latch is fully open, the ribbon cable will release freely.



Figure 6.5—Removal of the fieldbus interface board

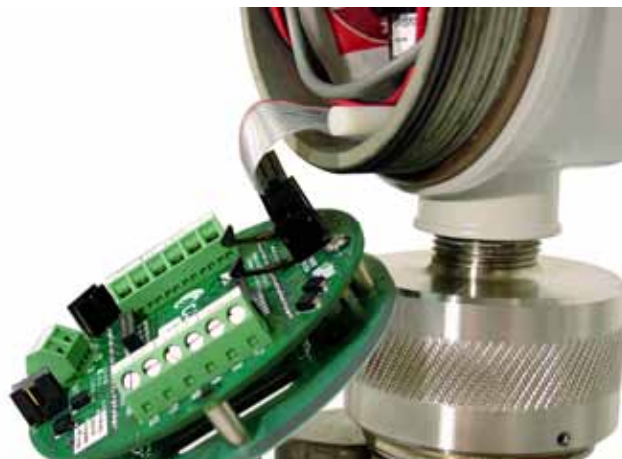

Figure 6.6—Latch securing the ribbon cable

11. Remove the main board/keypad assembly from the enclosure.
12. Remove the two #4-40 × 5/16” screws fastening the main board to the keypad ([Figure 6.7, page 76](#)).
13. Remove the keypad ribbon cable from the J7 connector on the LCD side of the main board by pressing in on the sides of the black plastic clip and pulling gently on the clip. Do not pull on the ribbon cable; the cable will release freely when the clip opens ([Figure 6.8](#)).
14. Discard the old main board and remove the replacement board from its packaging.
15. Connect the keypad ribbon cable to the J7 connector on the LCD side of the new main board as follows:
 - a. Slide the end of the ribbon into the black clip as far as it will go.
 - b. Press the black plastic clip into the connector until it snaps.

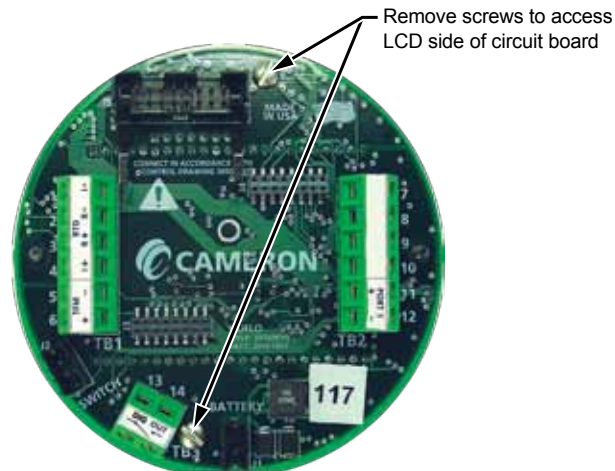

Figure 6.7—Disassembly of main board/keypad assembly

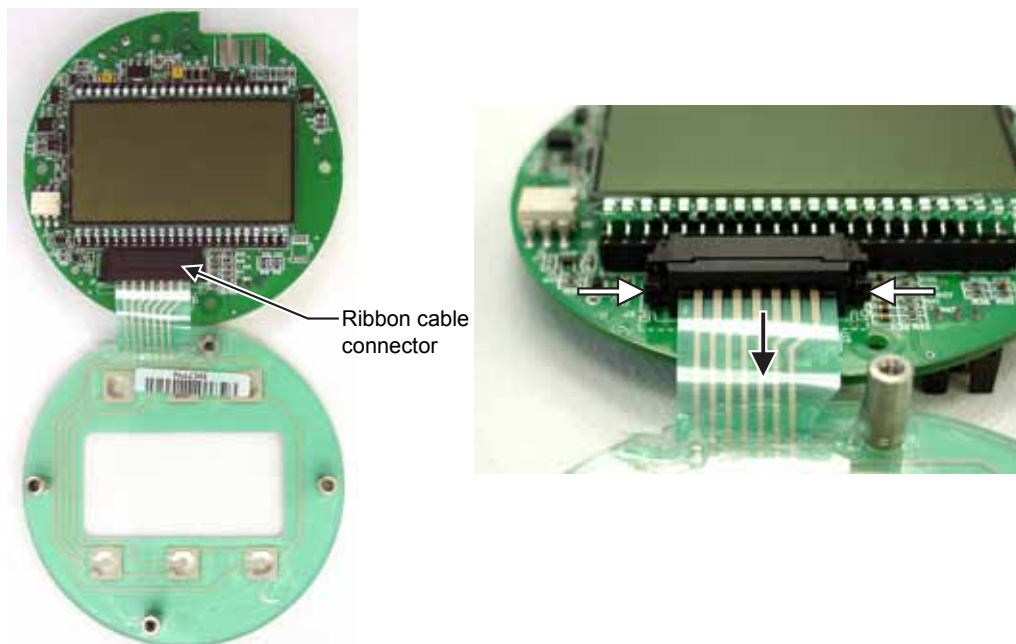

Figure 6.8—To release the ribbon cable from the connector, press in on the side tabs of the J7 connector (white arrows) and gently pull forward (black arrow).

16. Connect the main board to the keypad with the two #4-40 × 5/16” screws removed in step 12.
17. Reconnect the sensor ribbon cable to the J5 connector at the top of the main board, by inserting the ribbon cable into the black clip and securing the latch on the clip to hold it tightly in place.
18. Reattach the fieldbus interface board to the main board, being careful to align the pins on the back side of the interface board with the two headers on the main board before snapping the interface board into place and over the center standoff.
19. Reattach the white potted fieldbus module to the fieldbus interface board, being careful to align the pins on the back side of the module with the headers on the interface board.
20. Secure the fieldbus module with the two screws that were removed in step 8.
21. Reconnect all wiring to terminal blocks TB1, TB2 and TB3.
22. Reconnect the battery cable to connector J1 on the main board.
23. Reconnect the fieldbus input cable to terminal block TB4 on the fieldbus interface board.
24. Reattach the board assembly to the standoffs inside the enclosure with the two #4-40 × 7/8” screws removed in step 2.
25. Recalibrate the Scanner 2000.
26. Replace the enclosure cover.

Important Do not overlook the need to recalibrate the Scanner 2000. Boards that are shipped independently of a Scanner 2000 are not calibrated to compensate for atmospheric pressure; therefore, a Scanner 2000 will not display accurate pressure readings until it is recalibrated.

Fieldbus Interface Board

Important Static electricity can damage a circuit board. Handle new boards only by their edges, and use proper anti-static techniques (such as wearing anti-static wrist strap or touching metal to establish an earth ground) prior to handling a board.

To replace the fieldbus interface board, perform the following steps:

1. To access the fieldbus interface board, perform steps 1 through 9 of the main board replacement procedure on page 73.
2. Remove the replacement fieldbus interface board from its packaging and connect it to the main board, being careful to align the pins on the back side of the interface board with the two headers on the main board before snapping the interface board into place and over the center standoff.
3. Reattach the white potted fieldbus module to the fieldbus interface board, using the two screws that were removed in step 8 of the main board replacement procedure.
4. Reconnect all wiring to terminal blocks TB1, TB2 and TB3.
5. Reconnect the battery cable to connector J1 on the main board.
6. Reconnect the fieldbus input cable to terminal block TB4 on the fieldbus interface board.

7. Reattach the board assembly to the standoffs inside the enclosure with the two #4-40 × 7/8” screws removed in step 2 of the main board replacement procedure.
8. Replace the enclosure cover.

Fieldbus Module

Important **If possible, save the network configuration settings before replacing the fieldbus module. See the host manual or configuration tool manual for instructions.**

1. To remove the white potted fieldbus module from the device, perform steps 1 through 8 of the main board replacement procedure on page 73.
2. Remove the replacement fieldbus module from its packaging and connect it to the fieldbus interface board, being careful to align the pins on the back side of the module with the headers on the interface board.
3. Secure the fieldbus module with the two screws that were removed in step 8 of the main board replacement procedure.
4. Reconnect all wiring to terminal blocks TB1, TB2 and TB3.
5. Reconnect the battery cable to connector J1 on the main board.
6. Reconnect the fieldbus input cable to terminal block TB4 on the fieldbus interface board.
7. Reattach the board assembly to the standoffs inside the enclosure with the two #4-40 × 7/8” screws removed in step 2 of the main board replacement procedure.
8. Replace the enclosure cover.
9. Reconfigure the fieldbus network.

Keypad Replacement

To replace the keypad of the Scanner 2000, perform the following steps:

1. To disconnect the keypad from the main board, perform steps 1 through 13 of the main board replacement procedure on page 73.
2. Remove the old keypad.
3. Remove the replacement keypad from its packaging and connect the ribbon cable to the J7 connector on the LCD side of the main board as follows:
 - a. Insert the end of the ribbon cable into the plastic clip.
 - b. While holding the ribbon cable in place, press the black plastic clip into the connector until it snaps.
4. Mount the main board to the keypad with the two #4-40 × 5/16” screws removed in step 12 of the main board replacement procedure.
5. Reattach the fieldbus interface board to the main board, being careful to align the pins on the back side of the board with the two headers on the main board.

6. Reconnect the white potted fieldbus module to the fieldbus interface board, being careful to align the pins on the back side of the module with the header on the interface board, and secure it with the two screws removed in step 8 of the main board replacement procedure.
7. Reconnect all wiring to terminal blocks TB1, TB2 and TB3.
8. Reconnect the battery cable to connector J1 on the main board.
9. Reconnect the fieldbus input cable to terminal block TB4 on the fieldbus interface board.
10. Reattach the board assembly to the standoffs inside the enclosure with the two #4-40 × 7/8" screws removed in step 2 of the main board replacement procedure.
11. Recalibrate the Scanner 2000, if necessary.
12. Replace the enclosure cover.

MVT Replacement

Important Press the **ENTER/SAVE** key on the keypad before disconnecting the battery to save accumulated flow run and turbine volume totals (grand total and current day total), and energy and mass totals to memory.

To replace the MVT of the Scanner 2000, perform the following steps:

1. To disconnect the MVT ribbon cable from the main board, perform steps 1 through 10 of the main board replacement procedure on page 73.

Important The ribbon cable latch on the main board will not release without first removing the fieldbus module and the fieldbus interface board from the device.

2. Loosen the set screw in the side of the MVT adapter.
3. Rotate the adapter counterclockwise to break the connection with the MVT sensor body.
4. Detach the MVT sensor from the adapter, pulling the ribbon cable free.
5. Remove the replacement MVT from its packaging and route the ribbon cable through the adapter and up into the Scanner 2000 enclosure.
6. Screw the MVT into the adapter until it meets with resistance.
7. Slowly unscrew the MVT sensor until the vents on the sides of the MVT are oriented to the back of the enclosure.
8. Replace the set screw in the adapter and tighten.
9. Connect the ribbon cable from the sensor to the MVT connector (J5) on the main board.
10. Reattach the fieldbus interface board to the main board, being careful to align the pins on the back side of the board with the two headers on the main board.
11. Reconnect the white potted fieldbus module to the fieldbus interface board, being careful to align the pins on the back side of the module with the header on the interface board, and secure it with the two screws removed in step 8 of the main board replacement procedure.

12. Reconnect all wiring to terminal blocks TB1, TB2 and TB3.
13. Reconnect the battery cable to connector J1 on the main board.
14. Reconnect the fieldbus input cable to terminal block TB4 on the fieldbus interface board.
15. Reinstall the board assembly in the enclosure, using the screws that were removed in step 2 of the main board replacement procedure.
16. Recalibrate the Scanner 2000.
17. Replace the enclosure cover.

Important Do not overlook the need to recalibrate the Scanner 2000. MVTs that are shipped independently of a Scanner 2000 are not calibrated to compensate for atmospheric pressure; therefore, a Scanner 2000 will not display accurate pressure readings until it is recalibrated.

Section 7—Spare Parts



WARNING: Substitution of components may impair suitability for ATEX certification. Use of spare parts other than those identified by Cameron International Corporation voids hazardous area certification. Cameron bears no legal responsibility for the performance of a product that has been serviced or repaired with parts that are not authorized by Cameron.

Table 7.1—Scanner 2000 microEFM Spare Parts

Part Number	Description
9A-30160010	Circuit Assembly, Scanner 2000 EFM, CPU Board
2296336-01	Fieldbus Module, Scanner 2000 EFM
2296330-01	Circuit Assembly, Scanner 2000 EFM, Fieldbus Interface Board
9A-30166005	Assembly, Switchplate, Scanner 2000 EFM
9A-100002605	Desiccant, Humidisorb, Self Regenerate, 2 in. x 2 in. Packet with Adhesive
9A-30099008	Battery Pack, 2 “D” Batteries in Series, 7.2V, Lithium, with Current Limiting Resistor and Diode, ATEX, IS
9A-99177001	Adapter, 1 in. Female Pipe to ¾ in. Male Pipe, Plated Steel
9A-99177004	Adapter, 1 in. Female Pipe to ¾ in. Male Pipe, Brass
9A-99177005	Adapter, 1 in. Female Pipe to ¾ in. Male Pipe, 316 Stainless Steel
9A-100017622	Union, 1 in., Plated Steel
9A-99187003	Union, 1 in., Brass
9A-99187004	Union, 1 in., 316 Stainless Steel
9A-90017005	Cable Assembly, Turbine Pickup, 2 Pin Molded Connector, 18 in., ATEX
9A-99064006	Pipe Plug, ¾-14 NPT, Hex Socket, Brass
9A-99064008	Pipe Plug, ¾-14 NPT, Hex Socket, 316 Stainless Steel
9A-99189002	O-Ring, 97mm x 3.5mm, XD-I, Enclosure
9A-0119-1015J	Screw, Pan Head, 2-56 x 3/16, Stainless Steel
9A-99002019	Screw, Set, #8-32 X 3/16, Hex Socket, Stainless Steel
9A-100025380	Screw, Pan Head, Slotted, #4-40 X 7/8 Steel Black Oxide
9A-100025381	Washer, Flat, #4 Steel Black Oxide
9A-30074033	Assembly, Installation Software CD and CD Pocket Folder, ModWorX™ Pro
See Table 7.3	Multi-Variable Transmitter (selection based on pressure requirements)

Table 7.2—Scanner 2000 microEFM Optional Parts

Part Number	Description
9A-90017004	Adapter, Communications, 3/4 in. NPT Union, 2-Pin Connector, 10 in., for External RS-485 Communications
9A-0112-9015T	RS-232 to RS-485 Converter, Serial Port Powered, DB9 Connector on Both Ends
9A-101283116	RS-232 to RS-485 Converter, Serial Port Powered, DB9 Connector on PC End, Open Terminals on Instrument End
9A-30028004	Kit, Pole Mount, Plated Steel
9A-30028005	Kit, Pole Mount, Stainless Steel
2296352-01	Terminal Housing, 6-Position Terminal, 3 1/2 in. NPT Entry Ports
9A-99145007	Pickup, Intrinsically Safe, for use with NuFlo 7/8 in. to 8 in. Meters
9A-99145008	Pickup, Intrinsically Safe, for use with NuFlo 3/8 in. to 3/4 in. Meters
9A-2113-0001A-01	Pickup, Intrinsically Safe, for use with Barton 7000 Series 1/4 in. to 3/4 in. Meters
9A-2113-0001A-02	Pickup, Intrinsically Safe, for use with Barton 7000 Series 1 in. to 12 in. Meters
9A-1100-1025B-05	RTD Assembly, Weatherproof Strain Relief, Adjustable 6-in. Probe, 5-ft cable
9A-1100-1025B-10	RTD Assembly, Weatherproof Strain Relief, Adjustable 6-in. Probe, 10-ft cable
9A-1100-1025B-20	RTD Assembly, Weatherproof Strain Relief, Adjustable 6-in. Probe, 20-ft cable
9A-1100-1025B-30	RTD Assembly, Weatherproof Strain Relief, Adjustable 6-in. Probe, 30-ft cable

Table 7.3—Multi-Variable Transmitters

Select one based on specific application. The MVTs listed below have bottom ports. Side port models are available on request.

Part No. (non-NACE)	Part No. (NACE)	Part No. (Stainless Bolts)	Description
9A-99168041	9A-99168046	9A-99168097	100 PSIA, 30 IN H2O
9A-99168042	9A-99168047	9A-99168098	300 PSIA, 200 IN H2O
9A-99168075	9A-99168086	9A-99168099	300 PSIA, 840 IN H2O
9A-99168076	9A-99168087	9A-99168100	500 PSIA, 200 IN H2O
9A-99168043	9A-99168048	9A-99168101	1500 PSIA, 200 IN H2O
9A-99168077	9A-99168088	9A-99168102	1500 PSIA, 300 IN H2O
9A-99168078	9A-99168089	9A-99168103	1500 PSIA, 400 IN H2O
9A-99168079	9A-99168090	9A-99168104	1500 PSIA, 840 IN H2O
9A-99168044	9A-99168049	9A-99168105	3000 PSIA, 200 IN H2O
9A-99168080	9A-99168091	9A-99168106	3000 PSIA, 300 IN H2O
9A-99168081	9A-99168092	9A-99168107	3000 PSIA, 400 IN H2O
9A-99168082	9A-99168093	9A-99168108	3000 PSIA, 840 IN H2O
9A-99168045	9A-99168050	—	5300 PSIA, 200 IN H2O
9A-99168083	9A-99168094	—	5300 PSIA, 300 IN H2O
9A-99168084	9A-99168095	—	5300 PSIA, 400 IN H2O
9A-99168085	9A-99168096	—	5300 PSIA, 840 IN H2O
9A-99168116	—	—	5800 PSIA, 400 IN H2O
9A-99168117	—	—	5800 PSIA, 200 IN H2O

Appendix A—Scanner 2000 Hardware Options

External Communications Adapter (9A-90017004)

The external communications adapter (Figure A.1) provides an RS-485 connection for connecting a laptop or PC to the instrument without removing the instrument cover. When the adapter is ordered with a Scanner 2000, it is factory installed. It may be relocated to either conduit opening in the instrument housing.

An RS-232 to RS-485 converter cable (available from Cameron's Measurement Systems Division) is required for connecting the adapter to a laptop computer. A variety of converter cable options are listed in the Spare Parts list of this manual ([see page 81](#)).

The adapter is shipped pre-assembled in the Scanner 2000 when it is ordered with the unit. The installed adapter is comprised of an RS-485 adapter socket, a blanking plug, and a union nut. A plug connector that mates with the RS-485 adapter socket when the adapter is in use is shipped with the device (uninstalled). This plug connector should be wired to an RS-485 converter cable, and stored with the cable when the COM adapter is not in use. Wiring instructions for connecting the plug connector to an RS-485 converter cable are provided in [Figure A.3, page A-2](#).



WARNING: Connect a laptop to the external communications adapter only when the area is known to be non-hazardous.

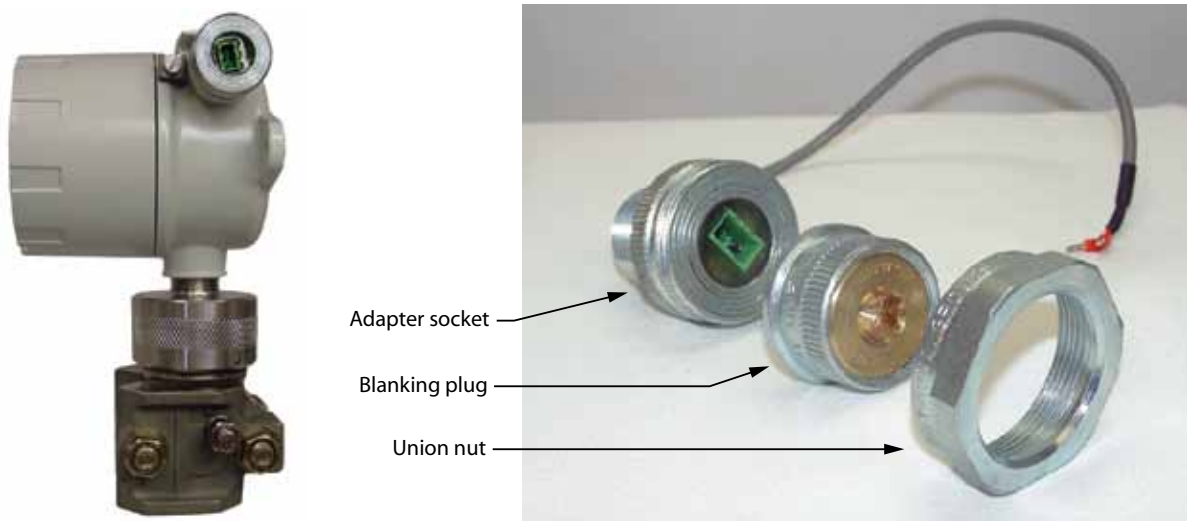

Figure A.1—External communications adapter

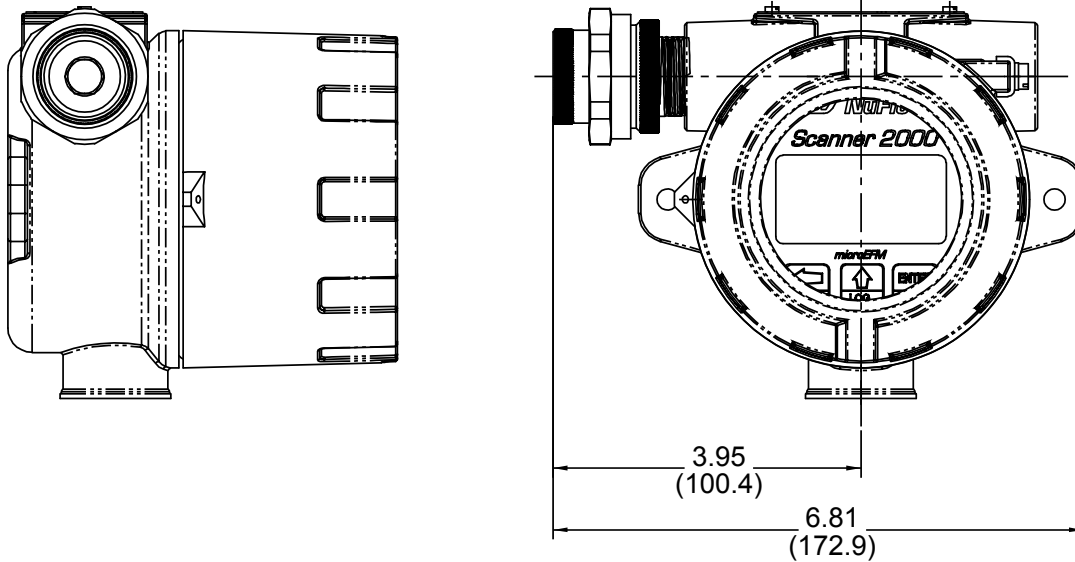

Figure A.2—Dimensions of external communications adapter; inches (mm)

To connect a PC or laptop to the communications adapter, perform the following steps:

1. Unscrew the union nut to expose the connector socket shown in Figure A.1, page A-1. A blanking plug will be removed with the union nut. Store the union nut and blanking plug in a safe place. (They will need to be reinstalled when the adapter is not in use.)
2. Connect the plug connector to an RS-485 converter cable, if it is not already attached (Figure A.3).

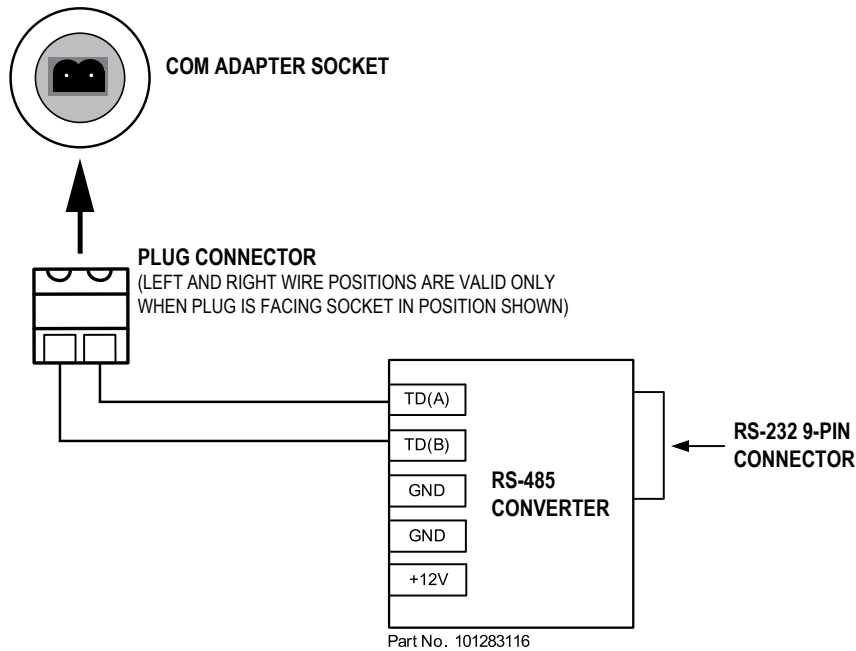

Figure A.3—Wiring of plug connector to Cameron 9-pin RS-232 to RS-485 converter cable

3. Insert the plug connector into the adapter socket.
4. Connect the converter cable to the PC or laptop.

To disconnect the adapter, remove the plug connector (with converter cable attached) from the socket, place the blanking plug inside the union nut (removed in step 1) and screw the union nut onto the union half to cover the socket. Hand-tighten to ensure a snug connection.

Note Do not disconnect the plug connector from the RS-232 to RS-485 converter cable when it is not in use. For best results, store the plug connector with the converter cable.

Communications Adapter Installation (for adapters purchased separately from a Scanner 2000)



WARNING: If the communications adapter is ordered separately from the Scanner 2000 microEFM, the conduit openings in the Scanner 2000 enclosure will be sealed with brass or stainless steel plugs. Do not remove the plug from the enclosure to install the adapter unless the area is known to be non-hazardous.

To install a communications adapter purchased separately from a Scanner 2000 microEFM, perform the following steps:

1. Thread the cable of the adapter through a conduit opening in the instrument housing and screw the adapter into place.
2. Connect the adapter cable to communications port 1 on the main board inside the Scanner 2000 housing. See [Figure 3.8, page 53](#), for a wiring diagram.
3. Connect the plug connector to an RS-485 converter cable, if applicable.

Pole-Mounting Kit (Part No. 9A-30028005)

A hardware kit consists of a mounting bracket, two U-bolts and nuts allows the Scanner 2000 to be mounted on a 2-in. pole. The mounting bracket also provides the extension necessary to keep the instrument in a vertical position when it is bulkhead-mounted to a flat, vertical surface.

Pole-Mount Installation

To mount the Scanner 2000 using the optional pole-mount kit, perform the following steps:

1. Determine the pipe orientation (horizontal or vertical) that will best accommodate process connections and field wiring connections. A horizontal pipe mount is recommended for liquid and steam installations using a side-port MVT and block manifold.
2. Connect the mounting bracket to the Scanner 2000 using the two bolts provided.
3. Position the U-bolt around the pipe and through the support bracket provided with the U-bolt ([Figure A.4, page A-4](#)).
4. Align the mounting bracket against the pole so that the U-bolt passes through the mounting holes in the bracket. Place the mounting plate over the threaded ends of the U-bolt and against the bracket, and secure the U-bolt with the two nuts provided.
5. Install and connect process piping between the Scanner 2000 and the orifice meter with appropriate fittings. Process piping installation procedures vary with each application.

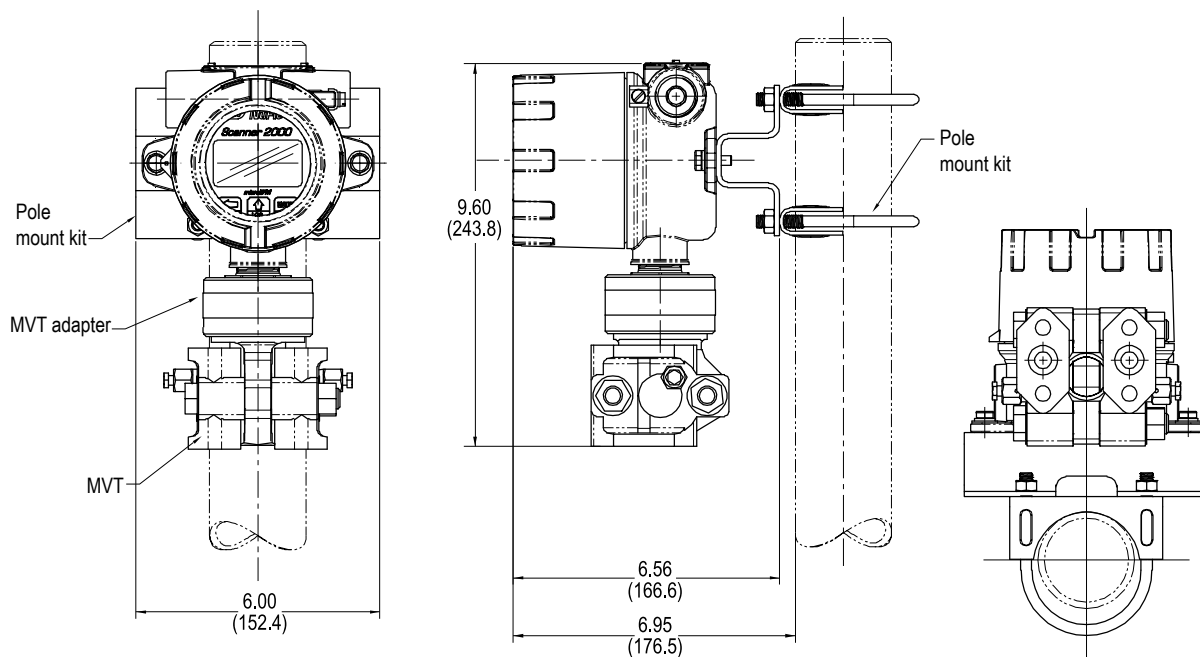

Figure A.4 —Scanner 2000 with MVT, remote-mounted on a 2-in. pole using a NuFlo hardware kit (Part No. 9A-30028004)

Important The vertical pipe mount configuration shown in Figure A.4 is not recommended for side-port MVTs when mated with a block manifold for liquid or steam measurement. A horizontal pipe mount should be considered for these installations.

Terminal Housing (Part No. 2296352-01)

The standard Scanner 2000 provides two conduit entries for input cable. For installations requiring more than two inputs, a four-outlet optional terminal housing (junction box) is recommended.

The terminal housing mates to one of the Scanner's conduit openings and provides three conduit openings for field wiring, in addition to the remaining conduit opening in the top of the Scanner 2000 housing. When combined in one order, the terminal housing and Scanner 2000 are connected at the factory with the required fittings, and the terminals for customer-designated inputs are factory-wired to a six-position terminal strip in the terminal housing. Cable glands are provided by the customer.

The terminal housing greatly simplifies field wiring, since there is no need for the customer to change wiring connections on the main board. The customer simply routes the input/output cables through cable glands and connects them to the appropriate positions on the terminal housing terminal strip. [Figure A.5, page A-5](#), shows an example of a terminal housing used for fieldbus power and RTD inputs.

See also the wiring instructions in [Figure A.6, page A-5](#), and [Figure A.7, page A-6](#).

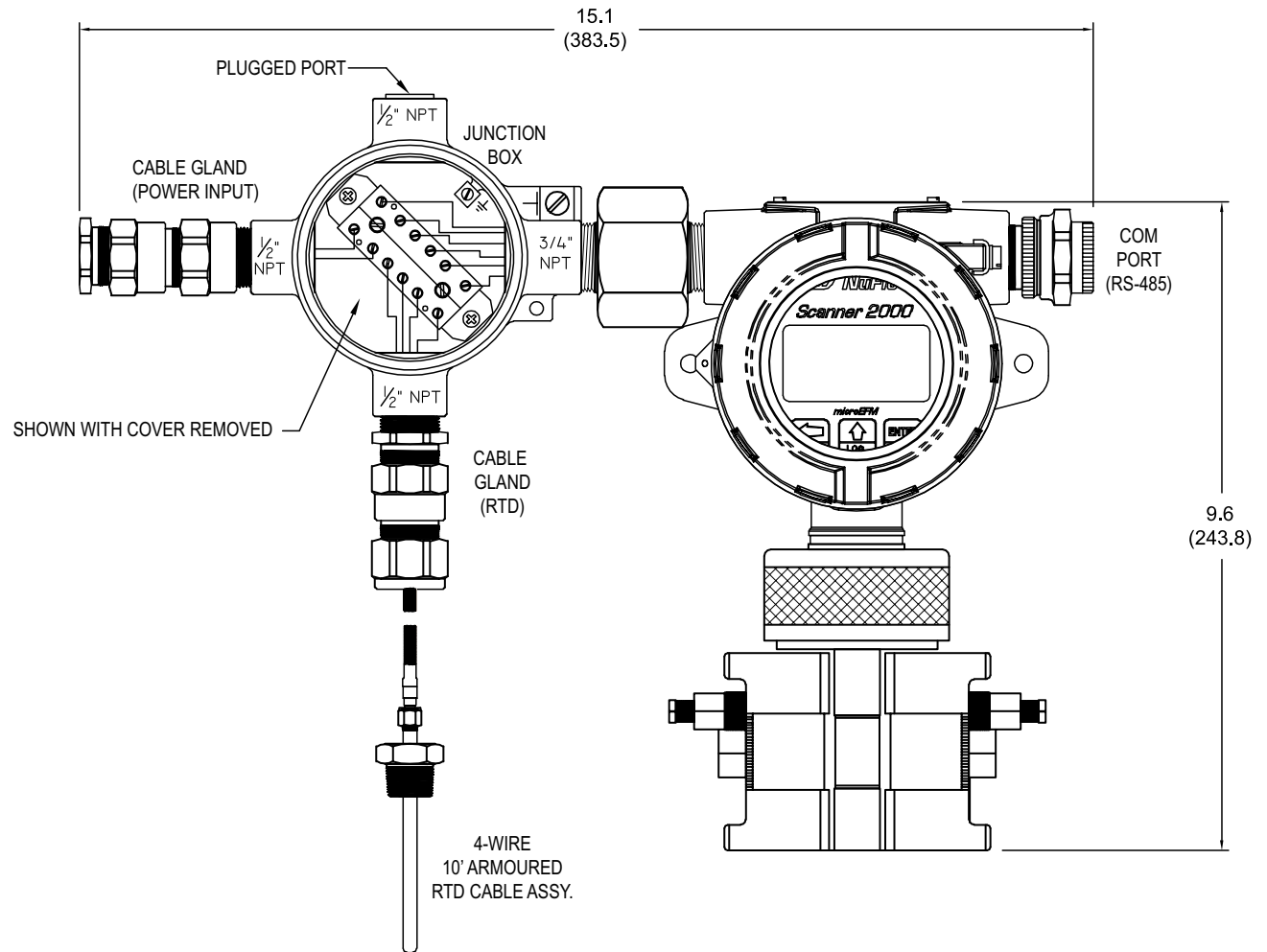

Figure A.5—Terminal housing installation dimensions

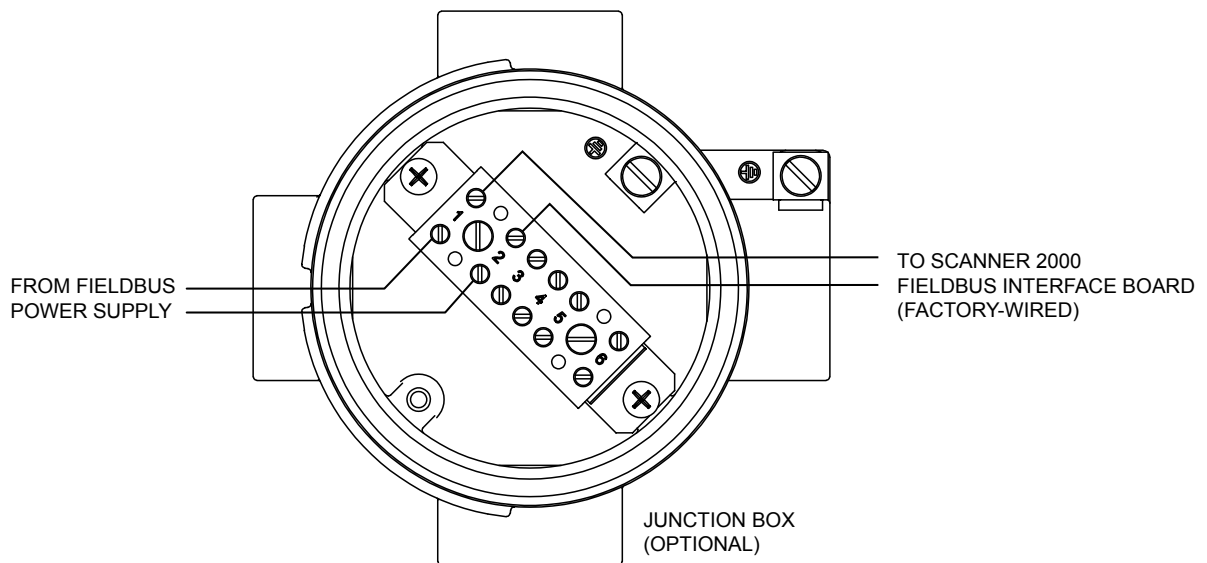

Figure A.6—FOUNDATION™ fieldbus power supply wiring with terminal housing

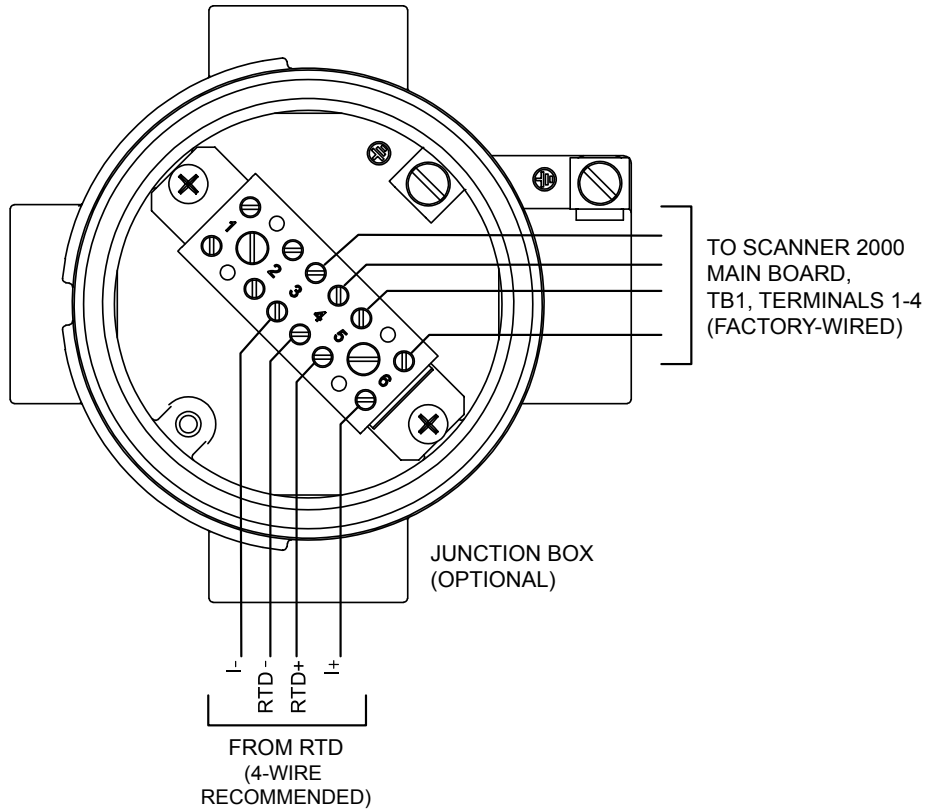

Figure A.7— FOUNDATION™ fieldbus process temperature input wiring with terminal housing

Appendix B—Lithium Battery Information

Transportation Information



WARNING: The Scanner 2000 microEFM contains lithium batteries. The internal component (thionyl chloride) is hazardous under the criteria of the Federal OSHA Hazard Communication Standard 29 CFR 1920.1200. Before shipping a lithium battery or equipment containing a lithium battery, verify that the packaging and labeling conforms with the latest version of all applicable regulations.

The transport of the lithium batteries is regulated by the United Nations, “Model Regulations on Transport of Dangerous Goods,” (special provisions 188, 230, and 310), latest revision.

Within the US the lithium batteries and cells are subject to shipping requirements under Part 49 of the Code of Federal Regulations (49 CFR, Parts 171, 172, 173, and 175) of the US Hazardous Materials Regulations (HMR), latest revision.

Shipping of lithium batteries in aircraft is regulated by the International Civil Aviation Organization (ICAO) and the International Air Transport Association (IATA) requirements in Special Provisions A45, A88 and A99, latest revision.

Shipping of lithium batteries on sea is regulated the International Maritime Dangerous Goods (IMDG) requirements in special provisions 188, 230 and 310, latest revision.

Shipping of lithium batteries on road and rail is regulated by requirements in special provisions 188, 230 and 310, latest revision.

Lithium Battery Disposal

Once a lithium battery is removed from a device and/or is destined for disposal, it is classified as solid waste under EPA guidelines. Depleted lithium batteries are also considered to be hazardous waste because they meet the definition of Reactivity, as per 40 CFR 261.23(a)(2), (3) and (5). This document describes how the lithium reacts violently with water, forms potentially explosive mixtures with water, and when exposed to certain pH conditions, generates toxic cyanide or sulfide gases.

Federal law requires that depleted lithium battery packs be sent to a fully permitted Treatment, Storage and Disposal Facility (TSDF) or to a permitted recycling/reclamation facility.



WARNING: Explosion/Fire Risk. Never handle or store the lithium battery in an environment that will exceed 100°C (212°F). Consult the MSDS for complete handling instructions.

Important Do not ship lithium battery packs to Cameron’s Measurement Systems Division. Cameron facilities are not permitted recycling/ reclamation facilities.

CAUTION Profiling and waste characterization procedures must be followed prior to shipping a lithium battery to a disposal site. It is the shipper’s responsibility to comply with all applicable federal transportation regulations (see below).

Material Safety Data Sheet

For a link to the current MSDS for the lithium batteries used to power the Scanner 2000 microEFM, see the Measurement Systems Division section of the Cameron website: www.c-a-m.com.

Appendix C—Fieldbus Communications Protocol

Device Properties

The following data may be useful in identifying the Scanner 2000 device and device description in a host network:

- Manufacturer's ID: 0x43414D
- Device Type: 01
- Device Revision: 01
- Device Description Revision (Initial Release): 01
- Device ID: 43414D0001_FBK_XXX where XXX is the serial number for the fieldbus module
- Default Physical Device (PD) Tag: SCANNER2000FF_01_FBK_XXX where XXX is the serial number for the fieldbus module
- Default Node Address: 248

Parameter Tables

The tables in this section define the FOUNDATION Fieldbus parameters supported by the Scanner 2000 fieldbus module.

- Table 1 presents resource block parameters,
- Table 2 presents transducer block parameters.
- Table 3 lists analog input function block parameters.
- Table 4 describes the error messages that may be generated for process variable parameters.

Table C.1—Resource Block Parameters

Index	Parameter	Definition
400	NAME	Block name and record member information
401	ST_REV	Revision level of the static data associated with the function block
402	TAG_DESC	User description of the intended application of the block
403	STRATEGY	Group identification number of the block
404	ALERT_KEY	Identification number of the plant unit
405	MODE_BLK	Mode of function block (ACTUAL, TARGET, PERMITTED, AND NORMAL)
406	BLOCK_ERR	Error status on hardware or firmware components related to this block
407	RS_STATE	State of function block application state machine
408	TEST_RW	READ/ WRITE test parameter used only for the conformance test
409	DD_RESOURCE	String identifying the tag of the resource which contains the Device Description for the resource
410	MANUFAC_ID	Manufacturer identification number
411	DEV_TYPE	Manufacturer's model number associated with the resource
412	DEV_REV	Manufacturer's revision number associated with the resource

Table C.1—Resource Block Parameters

Index	Parameter	Definition
413	DD_REV	Revision of the device description associated with the resource
414	GRANT_DENY	Option for controlling access of host computer and local panel to operating, tuning and alarm parameters of the block
415	HARD_TYPES	The types of hardware available as channel numbers
416	RESTART	Enables a manual restart of fieldbus module to be initiated. Selections include 1: Run, 2: Resource (restart resource block), 3: Defaults (restart with defaults), and 4: Processor (restart processor).
417	FEATURES	Shows supported resource block options
418	FEATURE_SEL	Allows selection of resource block options
419	CYCLE_TYPE	Identifies the block execution methods available for the resource block
420	CYCLE_SEL	Allows selection of the block execution method for the resource block
421	MIN_CYCLE_T	Time duration of the shortest cycle interval
422	MEMORY_SIZE	Available configuration memory in the empty resource
423	NV_CYCLE_T	Minimum time interval specified by the manufacturer for writing copies of non-volatile parameters to non-volatile memory. Zero means Never.
424	FREE_SPCE	Percentage of memory available for further configuration. Zero in a preconfigured resource.
425	FREE_TIME	Percentage of the block processing time that is free to process additional blocks
426	SHED_RCAS	Time duration at which to give up on computer writes to function block RCas locations. Shed from RCas shall never happen when SHED_RCAS = 0."
427	SHED_ROUT	Time duration at which to give up on computer writes to function block ROut locations. Shed from Rout shall never happen when SHED_ROUT = 0.
428	FAULT_STATE	Condition set by loss of communication to an output block, or fault promoted to an output block or a physical contact. When Fault State condition is set, output function blocks will perform their FSTATE actions.
429	SET_FSTATE	Allows the Fault State condition to be manually initiated by selecting Set.
430	CLR_FSTATE	Writing a Clear to this parameter will clear the device fault state if the field condition, if any, has cleared.
431	MAX_NOTIFY	Maximum number of unconfirmed notify messages possible
432	LIM_NOTIFY	Maximum number of unconfirmed alert notify messages allowed
433	CONFIRM_TIME	Time the resource will wait for confirmation of receipt of a report before trying again. Retry shall not happen when CONFIRM_TIME = 0.
434	WRITE_LOCK	If set, no writes from anywhere are allowed, except to clear WRITE_LOCK. Block inputs will continue to be updated.

Table C.1—Resource Block Parameters

Index	Parameter	Definition
435	UPDATE_EVT	Alert generated by any change to the static data
436	BLOCK_ALM	Alarm used for all configuration, hardware, connection failure or system problems in the block. The cause of the alert is entered in the subcode field.
437	ALARM_SUM	Current alert status, unacknowledged states, unreported states, and disabled states of alarms associated with the function block.
438	ACK_OPTION	Selection of whether alarms associated with the block will be automatically acknowledged
439	WRITE_PRI	Priority of the alarm generated by clearing the write lock.
440	WRITE_ALM	This alert is generated if the write lock parameter is cleared.
441	ITK_VER	Major revision number of the interoperability test case used in certifying this device as interoperable.
442-464	Field Diagnostics	NOTE: Field Diagnostics (FD) parameters are not currently supported.

Table C.2—Transducer Block Parameters

Relative	Parameter	Definition
2000	NAME	Block name and record member Information
2001	ST_REV	Revision level of the static data associated with the function block
2002	TAG_DESC	User description of the intended application of the block
2003	STRATEGY	Group identification number of the block
2004	ALERT_KEY	Identification number of the plant unit
2005	MODE_BLK	Mode of function block (ACTUAL, TARGET, PERMITTED, AND NORMAL)
2006	BLOCK_ERR	Error status on hardware or firmware components related to this block
2007	UPDATE_EVT	Alert generated by any change to the static data
2008	BLOCK_ALM	Alarm used for all configuration, hardware, connection failure or system problems in the block. The cause of the alert is entered in the subcode field.
2009	TRANSDUCER_DIRECTORY	Specifies the number and starting indicies of the transducers in the transducer block
2010	TRANSDUCER_TYPE	Type of transducer block
2011	XD_ERROR	Error code for transducer error
2012	COLLECTION_DIRECTORY	Specifies the number, starting indicies, and DD Item IDs of the data collections in each transducer within a transducer block.
2013	PV_VALUE	Value of Primary value parameter and its status
2014	PV_UNIT	Enumerated unit for Primary value
2015	SV_VALUE	Value of Secondary value parameter and its status
2016	SV_UNIT	Enumerated unit for Secondary value
2017	TV_VALUE	Value of Tertiary value parameter and its status

Table C.2—Transducer Block Parameters

Relative	Parameter	Definition
2018	TV_UNIT	Enumerated unit for Tertiary value
2019	QV_VALUE	Value of Quaternary value parameter and its status
2020	QV_UNIT	Enumerated unit for Quaternary value
2021	SIMULATION_VALUE	Value of Simulation value parameter and its status
2022	COMM_STATE	Modbus Communication Status with Scanner 2000 FF
2023	MODBUS_TUNNEL	Enable access to Modbus register directly
2024	GENERIC_FLOAT_PARAM_1	FR1 Grand Total
2025	GENERIC_FLOAT_PARAM_2	FR1 Daily Total
2026	GENERIC_FLOAT_PARAM_3	FR1 Prev Total
2027	GENERIC_FLOAT_PARAM_4	T1 Grand Total
2028	GENERIC_FLOAT_PARAM_5	T1 Instant Flow Rate
2029	GENERIC_FLOAT_PARAM_6	T1 Daily Total
2030	GENERIC_FLOAT_PARAM_7	T1 Prev Total
2031	GENERIC_FLOAT_PARAM_8	User Defined Register 1
2032	GENERIC_FLOAT_PARAM_9	T1 K Factor
2033	GENERIC_FLOAT_PARAM_10	FR1 Plate Size
2034	GENERIC_USIGN16_PARAM_1	Firmware Version
2035	GENERIC_USIGN16_PARAM_2	Manufacturing Date
2036	GENERIC_USIGN16_PARAM_3	Serial Number High
2037	GENERIC_USIGN16_PARAM_4	Serial Number Low
2038	GENERIC_USIGN16_PARAM_5	T1 Flow Rate Unit
2039	GENERIC_USIGN16_PARAM_6	T1 Volume Unit
2040	GENERIC_USIGN16_PARAM_7	FR1 Volume Unit
2041	GENERIC_USIGN16_PARAM_8	Register Pointer 1
2042	GENERIC_USIGN32_PARAM_1	Control Register (see Table 5)

Table C.2—Transducer Block Parameters

Relative	Parameter	Definition
2043	GENERIC_USIGN32_PARAM_2	Real Time On SC2000 (YYMM)
2044	GENERIC_USIGN32_PARAM_3	Real Time On SC2000 (DDhh)
2045	GENERIC_USIGN32_PARAM_4	Real Time On SC2000 (mmss)
2046	GENERIC_USIGN32_PARAM_5	Not Used
2047	GENERIC_STRINGV_PARAM_1	Not Used
2048	GENERIC_STRINGV_PARAM_2	Not Used

Note The INDEX of AI block parameters in Table 3 contains a numeric prefix that reflects the AI block being read. AI1 = 500, AI2 = 600, AI3 = 700, AI4 = 800. For example, the index for the parameter “ST_REV” on AI block 1 will be 501 (the prefix “500” plus the “1” shown in the table below).

Table C.3—Analog Input Block Parameters

Index	Parameter	Definition
xx0	NAME	Block name and record member Information
xx1	ST_REV	Revision level of the static data associated with the function block
xx2	TAG_DESC	User description of the intended application of the block
xx3	STRATEGY	Group identification number of the block
xx4	ALERT_KEY	Identification number of the plant unit
xx5	MODE_BLK	Mode of function block (ACTUAL, TARGET, PERMITTED, AND NORMAL)
xx6	BLOCK_ERR	Error status on hardware or firmware components related to this block
xx7	PV	Primary analog value used to execute a function, or a process value associated with it
xx8	OUT	Primary analog value calculated as a result of executing the function
xx9	SIMULATE	When enabled, allows transducer analog input or output to the block to be manually supplied. When disabled, the simulate value and status track the actual value and status.
x10	XD_SCALE	Defines high and low scale values, engineering units code, and number of digits to the right of the decimal point used with the value obtained from the transducer for a specified channel
x11	OUT_SCALE	Defines high and low scale values, engineering units code, and number of digits to the right of the decimal point to be used in displaying the OUT parameter and other parameters which have the same scaling as OUT
x12	GRANT_DENY	Options for controlling access of host computer and local control panels to operating, tuning and alarm parameters of the block

Table C.3—Analog Input Block Parameters

Index	Parameter	Definition
x13	IO_OPTS	Options for altering input and output block processing.
x14	STATUS_OPTS	Options which the user may select in the block processing of status.
x15	CHANNEL	Identifies by number the logical hardware channel that is connected to an AI block
x16	L_TYPE	Determines if the values passed by the transducer block to the AI block may be used directly (Direct) or if the value is in different units and must be converted linearly (Indirect), or with square root (Ind Sqr Root), using the input range defined by the transducer and the associated output range
x17	LOW_CUT	Limit used in square root processing. If the transducer value falls below this limit, a value of zero percent of scale is used in block processing.
x18	PV_FTIME	Time constant of a single exponential filter for the Primary value, in seconds.
x19	FIELD_VAL	Raw value of the field device in percentage of the Primary value range. Status reflects the Transducer condition before signal characterization (L_TYPE) or filtering (PV_FTIME)."
x20	UPDATE_EVT	Alert generated by any change to the static data
x21	BLOCK_ALM	Alarm used for all configuration, hardware, connection failure or system problems in the block. The cause of the alert is entered in the subcode field.
x22	ALARM_SUM	Current alert status, unacknowledged states, unreported states, and disabled states of the alarms associated with the function block
x23	ACK_OPTION	Allows alarms associated with the block to be automatically acknowledged
x24	ALARM_HYS	Amount the Primary value must return to within the alarm limits before the alarm condition clears. Alarm hysteresis is expressed as a percentage of the Primary value span.
x25	HI_HI_PRI	Priority of high high alarm
x26	HI_HI_LIM	Limit of high high alarm in engineering units
x27	HI_PRI	Priority of high alarm
x28	HI_LIM	Limit of high alarm in engineering units
x29	LO_PRI	Priority of low alarm
x30	LO_LIM	Limit of low alarm in engineering units
x31	LO_LO_PRI	Priority of low low alarm
x32	LO_LOLIM	Limit of low low alarm in engineering units
x33	HI_HI_ALM	Status for high high alarm and its associated time stamp
x34	HI_ALM	Status for high alarm and its associated time stamp
x35	LO_ALM	Status of the low alarm and its associated time stamp
x36	LO_LO_ALM	Status of the low low alarm and its associated time stamp

NOTE The maximum time required to execute a Scanner 2000 AI block is 30 ms.

Table C.4—Transducer Error (XD_Error) and Block Alarm Codes

Value	Error	Description
16	Unspecified error	Indicates occurrence of unidentified error
17	General error	Error cannot be classified as one of the following errors
18	Calibration error	Error occurred during calibration of the device or calibration error detected during device operation
19	Configuration error	Error occurred during configuration of the device or configuration error detected during device operation
20	Electronics failure	Electronic component has failed
21	Mechanical failure	Mechanical component has failed
22	I/O failure	I/O failure has occurred
23	Data integrity error	Data stored within the system may no longer be valid due to non-volatile memory checksum failure, data verify after write failure, etc.
24	Software error	Software has detected an error. Possible causes: improper interrupt service routine, arithmetic overflow, watchdog timer, etc.
25	Algorithm error	Algorithm used in the transducer block produced an error. Possible causes: overflow, data reasonableness failure, etc.

Control Registers

The Control Registers allow specific functions to be implemented via the communications port. The following table shows the value to be written to the control register to implement the desired function.

Table C.5—Control Registers	
Code	Function
20000	Transfers the polling totals and averages and polling run times to the previous polling totals, averages and previous run-time registers, increments the polling index register, and resets the polling totals, averages and polling run-time registers.
30000	Clears all flow totals
30001	Clears Flow Run 1 totals
30003	Clears Turbine 1 totals
30004	Clear Turbine 2 totals
30050	Clears all pulse output latches
30051	Clears a Pulse Output 1 latch
30061	Adds pulses specified in Control Register 2 to Pulse Output 1 Accumulator
30100	Clear all Alarm States
30101	Clear Flow Run Alarm Status
30102	Clear Input Alarm Status
40000	Loads factory defaults
40040	Resets the microcontroller (watchdog)
50050	Creates a partial archive record (daily and interval)

Unit Conversion

The following table can be used to convert numeric code to units, which may be helpful in working with host systems that do not convert unit codes to text descriptions automatically.

Table C.6—Unit Conversions for XD Scale

Unit Code	Display (Fieldbus)	Unit	Unit Code	Display (Fieldbus)	Unit
1048	gallon	gallon	1097	kg/m ³	kilograms per cubic meter
1051	bbl	Barrel	1054	s	second
1034	m3	cubic meter	1058	min	minute
1038	L	liter	1059	h	hour
1043	ft3	cubic feet	1060	d	day
41060	ACF	actual cubic feet	1240	V	volt
42010	MCF	thousand cubic feet	1243	mV	millivolt
1053	SCF	standard cubic feet	1209	A	ampere
41070	ACM	actual cubic meter	1211	mA	milliampere
42080	E3M3	thousand cubic meter	1281	Ohm	Ohm
1143	psig	pounds per square inch gauge	1284	kOhm	kiloOhm
1130	Pa	pascal	1283	Mohm	megaOhm
1133	kPa	kilopascal	1019	in	inch
1132	Mpa	megapascal	1018	ft	feet
1137	bar	bar	1020	yd	yard
1146	inH2O	inches of water	1021	mile	mile
1157	mmHg	millimeters of mercury	1013	mm	millimeter
1155	inHg	inches of mercury	1012	cm	centimeter
1141	psi	pounds per square inch	1010	m	meter
1145	kg/cm2	kilogram per square centimeter	1011	km	kilometer
1138	mbar	millibar	1077	Hz	hertz
1002	°F	degree Fahrenheit	1081	kHz	kilohertz
1001	°C	degree Celsius	1080	MHz	megahertz
1000	K	Kelvin	1162	cP	centipoise
1003	°R	degree Rankine	56020	lb/ft_s	pounds per feet-second
1094	lb	pound	49990	CUSTOM	User Defined Custom Unit
1088	kg/cm2	kilogram	1362	gal/s	gallon per second
47010	MMBtu	million British thermal unit	1363	GPM	gallon per minute
1171	GJ	gigajoules	1364	gal/h	gallon per hour
1183	Btu	British thermal unit	1365	gal/d	gallon per day
1173	kJ	kilojoules	1371	bbl/s	barrel per second
1172	MJ	megajoules	1372	bbl/min	barrel per minute
1107	lb/ft ³	pounds per cubic foot	1373	bbl/h	barrel per hour
			1374	bbl/d	barrel per day
			1347	m3/s	cubic meter per second

Unit Code	Display (Fieldbus)	Unit
1348	m3/min	cubic meter per minute
1349	m3/h	cubic meter per hour
1350	m3/d	cubic meter per day
1351	L/s	liter per second
1352	L/min	liter per minute
1353	L/h	liter per hour
1354	L/d	liter per day
1356	CFS	cubic feet per second
1357	CFM	cubic feet per minute
1358	CFH	cubic feet per hour
1359	ft3/d	cubic feet per day
41061	ACF/s	actual cubic feet per second
41062	ACF/min	actual cubic feet per minute
41063	ACF/h	actual cubic feet per hour
41064	ACF/d	actual cubic feet per day
42011	MCF/s	thousand cubic feet per second
42012	MCF/min	thousand cubic feet per minute
42013	MCF/h	thousand cubic feet per hour
42014	MCF/d	thousand cubic feet per day
42021	SCF/s	standard cubic feet per second
1360	SCFM	standard cubic feet per minute
1361	SCFH	standard cubic feet per hour
42024	SCF/d	standard cubic feet per day
41071	ACM/s	actual cubic meter per second
41072	ACM/min	actual cubic meter per minute
41073	ACM/h	actual cubic meter per hour
41074	ACM/d	actual cubic meter per day
42081	E3M3/s	thousand cubic meter per second
42082	E3M3/min	thousand cubic meter per minute
42083	E3M3/h	thousand cubic meter per hour
42084	E3M3/d	thousand cubic meter per day

Unit Code	Display (Fieldbus)	Unit
1330	lb/s	pound per second
1331	lb/min	pound per minute
1332	lb/h	pound per hour
1333	lb/d	pound per day
1322	kg/s	kilogram per second
1323	kg/min	kilogram per minute
1324	kg/h	kilogram per hour
1325	kg/d	kilogram per day
47011	MMBtu/s	million British thermal unit per second
47012	MMBtu/min	million British thermal unit per minute
47013	MMBtu/h	million British thermal unit per hour
47014	MMBtu/d	million British thermal unit per day
47021	GJ/s	gigajoules per second
47022	GJ/min	gigajoules per minute
47023	GJ/h	gigajoules per hour
47024	GJ/d	gigajoules per day
1445	Btu/s	British thermal unit per second
1446	Btu/min	British thermal unit per minute
1197	Btu/h	British thermal unit per hour
1447	Btu/d	British thermal unit per day
1438	kJ/s	kilojoules per second
1439	kJ/min	kilojoules per minute
1440	kJ/h	kilojoules per hour
1441	kJ/d	kilojoules per day
1442	MJ/s	megajoules per second
1443	MJ/min	megajoules per minute
1196	MJ/h	megajoules per hour
1444	MJ/d	megajoules per day
49991	CUSTOM/s	user defined custom unit per second
49992	CUSTOM/min	user defined custom unit per minute
49993	CUSTOM/h	user defined custom unit per hour
49994	CUSTOM/d	user defined custom unit per day

WARRANTY - LIMITATION OF LIABILITY: Seller warrants only title to the products, software, supplies and materials and that, except as to software, the same are free from defects in workmanship and materials for a period of one (1) year from the date of delivery. Seller does not warranty that software is free from error or that software will run in an uninterrupted fashion. Seller provides all software "as is". THERE ARE NO WARRANTIES, EXPRESS OR IMPLIED, OF MERCHANTABILITY, FITNESS OR OTHERWISE WHICH EXTEND BEYOND THOSE STATED IN THE IMMEDIATELY PRECEDING SENTENCE. Seller's liability and Buyer's exclusive remedy in any case of action (whether in contract, tort, breach of warranty or otherwise) arising out of the sale or use of any products, software, supplies, or materials is expressly limited to the replacement of such products, software, supplies, or materials on their return to Seller or, at Seller's option, to the allowance to the customer of credit for the cost of such items. In no event shall Seller be liable for special, incidental, indirect, punitive or consequential damages. Seller does not warrant in any way products, software, supplies and materials not manufactured by Seller, and such will be sold only with the warranties that are given by the manufacturer thereof. Seller will pass only through to its purchaser of such items the warranty granted to it by the manufacturer.

MEASUREMENT SYSTEMS

HOUSTON
HEAD OFFICE | **281.582.9500**

NORTH
AMERICA | **1.800.654.3760**
ms-us@c-a-m.com

ASIA
PACIFIC | **+603.5569.0501**
ms-kl@c-a-m.com

EUROPE,
MIDDLE EAST
& AFRICA | **+44.1243.826741**
ms-uk@c-a-m.com

USA • CANADA • UK • CHINA • UAE • ALGERIA • MALAYSIA • INDIA • RUSSIA

www.c-a-m.com/flo

