

INSTALLATION AND MAINTENANCE DATA SHEET

AA-51 Series lighting fixtures for Hazardous Location.

Class I, Div. 1 & 2, Groups A, B, C, D
Suitable for Group A, when used with Pendant Mount Only
Class II, Div. 1, and 2, Groups F and G
Class III

⚠ WARNING GENERAL

1. DO NOT MODIFY UNIT IN ANY WAY. Modification may affect safety and reliability.
2. Improper use or failure to follow these instructions could result in serious injury or property damage.
3. Operator should be instructed in the safe and proper usage and maintenance of this product.

⚠ WARNING ELECTRICAL

1. Disconnect electrical power before installation, adjustment and maintenance.
2. DO NOT overload; the amperage and voltage indicated on the name plate must not be exceeded.
3. Check continuity before connecting electrical power.
4. All installations must comply with applicable local and/or National Electrical Code.
5. Before installing check fixture unit nameplate and carton labels to be sure you have correct fixture and mounting hood. Circuit must be deactivated before installing fixture.

⚠ CAUTION GENERAL

1. All AA-51 Series Fixtures are to be mounted vertically with lamp base up.

The fixture unit MUST BE installed with one of the following mounting hoods for safe operation. Failure to use fixture unit with one of the following mounting hoods voids warranty as well as the U.L. Listing and creates the risk of fire or explosion.

FIGURE 1

The AA-51 fixture MUST BE installed with:

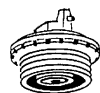
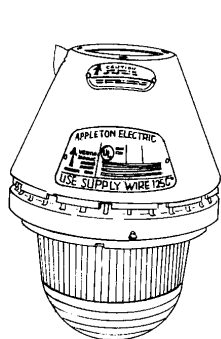

AAP-50, AAP-75
Pendant Hood - ONLY
***Group A with this hood.**
(One Hub) Rigid or flexible mounting.

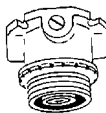

AAC-50, AAC-75
Ceiling Hood (Four hubs three close-up plugs)

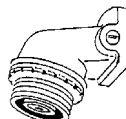

AASB-50, AASB-75
Short Wall Bracket Hood
(Two hubs one close-up plug)

⚠ IMPORTANT: Remove all unused conduit plugs and reinstall with pipe sealant.

DIRECTIONS FOR FIXTURE INSTALLATION

Use the installation drawing as a guide. Install mounting hood first as all wiring connections are made in the mounting hood. The fixture unit requires no internal wiring connections.

1. Remove the connection block (VPT-7) from the mounting hood by loosening (but not removing) the two Phillips head screws. Turn connection block counter-clockwise to remove.
2. When using ceiling (AAC-) or short bracket (AASB-), mounting hoods, threaded adapter (59064050000) can be removed by lifting gasket (59064034000) to access set screw.
 - Loosen set screw and turn adapter counter-clockwise for easier access to junction box.
3. Install mounting hood to conduit system (and/or wall or ceiling). If using pendant, secure the hood to the conduit system with the set screw.
4. Pull supply wires from the conduit into the junction box.
 - Use supply wire rated 110° C minimum.
5. Secure threaded adapter (where applicable) to junction box and tighten all set screws. Make connection of supply wires to the VPT-7 connection block by attaching "hot" voltage lead to the brass terminal and common "neutral" lead to silver terminal.
6. Secure VPT-7 connection block to threaded adapter or mounting hood by slipping over Phillips head screws; turning clockwise and tightening screws.
7. Install lamp into fixture unit. See directions under "Lamp Installation Instructions."
8. Inspect threads of mounting hoods and of the fixture unit to be sure they are clean and free of damage. Inspect globe for any chips, scratches or cracks.

⚠ CAUTION
Chipped, scratched or cracked globes will fail. Replace any such defective lamp housing.

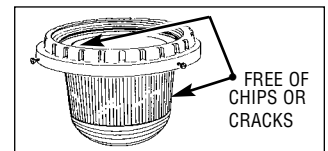

9. Thread the fixture unit into mating threads of mounting hood until tight against gasket of mounting hood. Locking spring of fixture unit should engage with notches on mounting hood.
10. Install guard and/or reflector if desired. Check tightness of set screws and all threaded joints. Activate supply circuit to test fixture.

KEEP THIS MANUAL FOR FUTURE REFERENCE

LAMP INSTALLATION INSTRUCTIONS

FIGURE 2

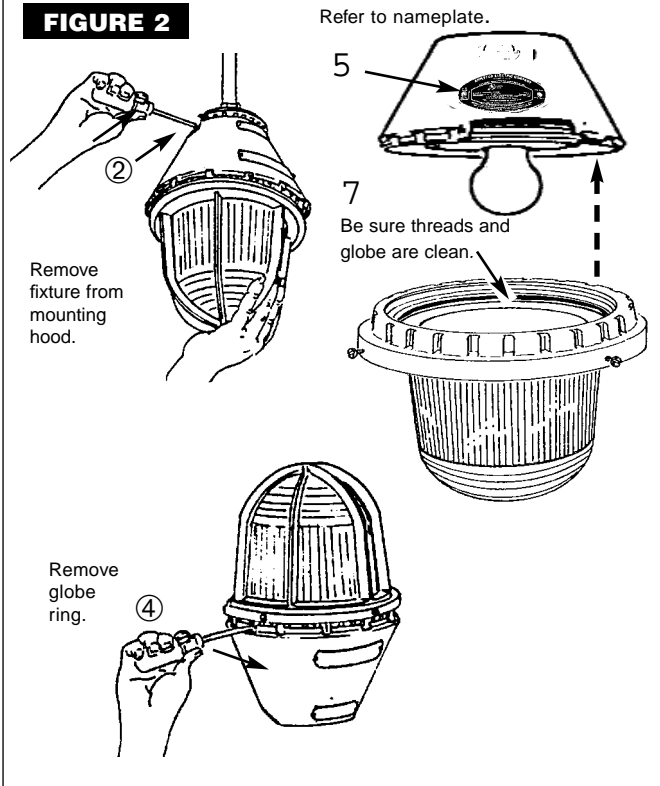

CAUTION: All AA-51 series fixtures are to be mounted vertically with lamp base up.

NOTE: All installations must comply with applicable local and/ or National Electrical Code.

CAUTION : Disconnect supply circuit before opening or relamping fixture.

- A lamp may be safely and easily installed into the fixture at a work bench.
- 1. Disconnect fixture from supply circuit.
- 2. Remove fixture unit from mounting hood by inserting screw driver into canopy notches and using release lugs for leverage.
- Once loosened from mounting hood, fixture unit can be quickly unscrewed by hand. **Do not remove fixture unit from mounting hood under load.**
- 3. Place fixture unit on bench with globe side up.
- 4. Remove globe ring using pry notches if necessary, turning counter clockwise
- 5. Refer to fixture nameplate for proper lamp wattage and type.
- **Inspect globe for chips or scratches.**
- 6. Carefully thread globe assembly into fixture unit until it is tightly in place.
- 7. Thread Fixture unit onto mounting hood as per Directions for Fixture Installation, (see numbers 8 and 9 page 1).

CAUTION : Disconnect supply circuit before opening or relamping fixture.

MAINTENANCE DATA

- To relamp, see "Lamp Installation Instructions."
 - To maintain maximum light output from this fixture, it should be cleaned periodically as follows:
1. The aluminum exterior of this fixture should be cleaned only with a mild soap or cleaner, and should be rinsed with water immediately. *Alkaline or acidic cleaners will attack the protective coating of epoxy on the fixture and should not be used.* This will allow the epoxy to protect the fixture from corrosive elements in the atmosphere and result in longer fixture life.
 2. The glass globe should be cleaned using a soft cloth and a non-abrasive cleaner. The globe should be regularly inspected for scratches or chips. If the globe is scratched or chipped, it must be replaced.
 3. The porcelain enamel reflector may be cleaned with any non-abrasive detergent or glass cleaner.
- These periodic cleaning procedures are important to prevent the accumulation of dust and dirt which will impair the light output of the fixture.
 - When relamping, be careful not to damage the external threaded areas, since they maintain the fixture's explosion-proof properties.
 - When removing and repairing fixture lubricate threads only with Appleton TLC-3 conductive, high temperature lubricant. This should only be necessary if threads are no longer coated with the blue or black color of the TLC-3 dry film teflon lubricant.
 - See Page 3 , Figure 5 for replacement parts list.

OPERATIONAL DATA

- The fixture must be operated in an environment that does not exceed 40°C.
- The fixture may be operated on AC power only up to 300 volts. Use lamp rated for operating voltage.
- Use supply wire rated 110°C minimum.

WARNING

- To reduce the risk of fire or explosion, do not install where the operating temperature exceeds ignition temperature of hazardous atmospheres.
- Refer to the nameplate on the fixture for maximum operating temperature and for proper fixture classification.

SHORT BRACKET INSTALLATION

1. Remove threaded adapter from junction box for easier access to conduit system.
 2. Remove VPT-7 Connection Block from threaded adapter. Pull supply wire (110°C minimum) into junction box.
 3. Replace threaded adapter and secure set screw.
 4. Connect supply wires to appropriate terminal screws on VPT-7 block per installation instructions.
 5. Push VPT-7 connector block into place and tighten screws. Install fixture unit.
- Remove unused plug and reinstall with pipe sealant.

FIGURE 3

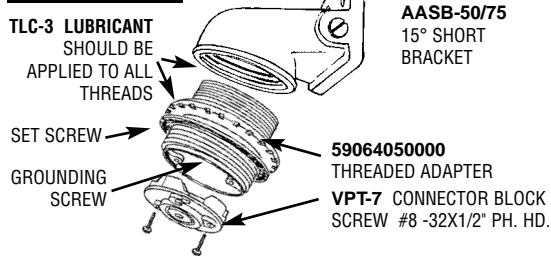

SOCKET REPLACEMENT INSTRUCTIONS

1. Remove fixture unit from mounting hood and remove globe assembly per directions under "Lamp Installation Instructions".
2. With socket side up, locate connection block set screw. (8-32x15/16" slotted headless screw) below socket, neat pyrex cylinder wall. Loosen set screw.
3. Place fixture unit with socket side down on soft clean level work surface.
 - Threaded opening of fixture unit with contact ring and center pin should be exposed.
 - Fixture nameplate should be right side up.
4. Locate pry nipples on top of exposed socket contact block assembly. Use preferably adjustable pliers against opposing dimples and loose block assembly counter-clockwise.
 - Once loose, block should be easily removed by hand turning counter-clockwise.
5. Install new socket assembly by threading clockwise into top of fixture unit. Continue until hand tight against mating surface.
 - Check by turning fixture unit upside down to see that no gap remains between cast interior and block.
 - Do not over-torque the socket assembly into place, a hand tightened socket assembly is sufficient to maintain integrity of fixture.
 - DO NOT use socket to turn or remove assembly. See insert at right.
6. Tighten connection block set screw.
7. Reassemble fixture per directions under "Lamp Installation Instructions".

FIGURE 4

ONLY
AAP-50 — AAP-75
PENDANT HOOD
ASSEMBLY
CLASS I, DIVISION 1
GROUP 'A'

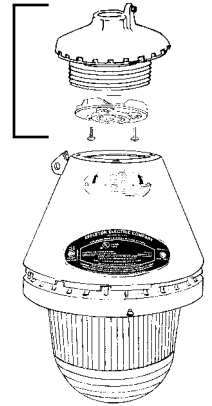
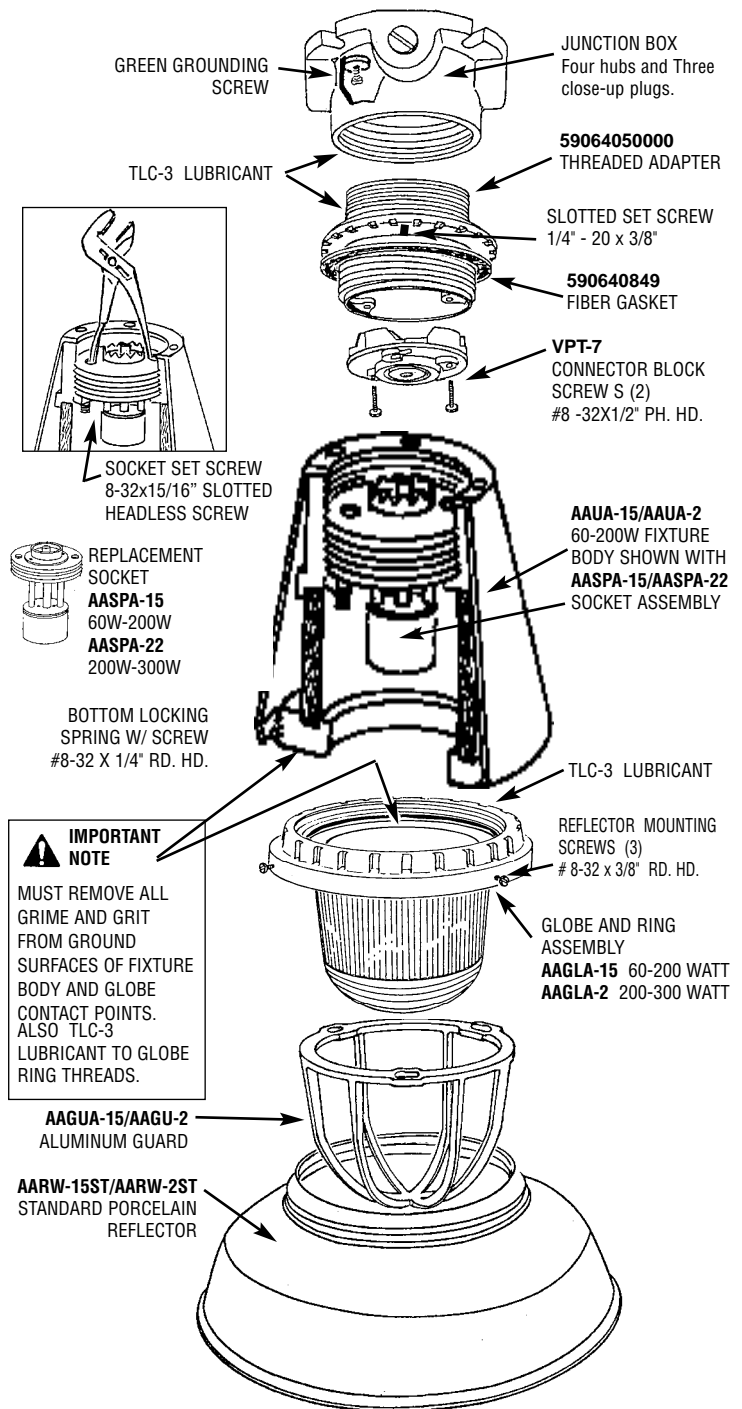

FIGURE 5

AA-51 INCANDESCENT FIXTURE SHOWN AS CEILING MOUNT WITH AAC MOUNTING HOOD



AA-51 GROUPS A & B LIGHTING FIXTURES FAMILY TREE

MOUNTING HOODS

Pendant
One Hub
1/2" AAP-50
3/4" AAP-75

Ceiling
Three close-up plugs
1/2" AAC-50
3/4" AAC-75

15° Short Bracket
One close-up plug.
1/2" AASB-50
3/4" AASB-75

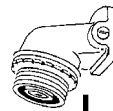

LAMP HOUSING
MED. BASE LAMP
60/200W (PS-25)
AAUA-15

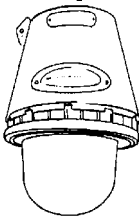

LAMP HOUSING
MED. BASE LAMP
200/300W (PS-25 OR PS30)
AAUA-2

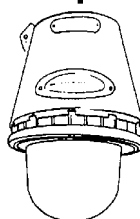

ALUMINUM GUARD
AAGUA-15



ALUMINUM GUARD
AAGU-2

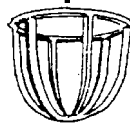

Dimensions: AA-51 Groups A & B Incandescent Lighting Fixtures.

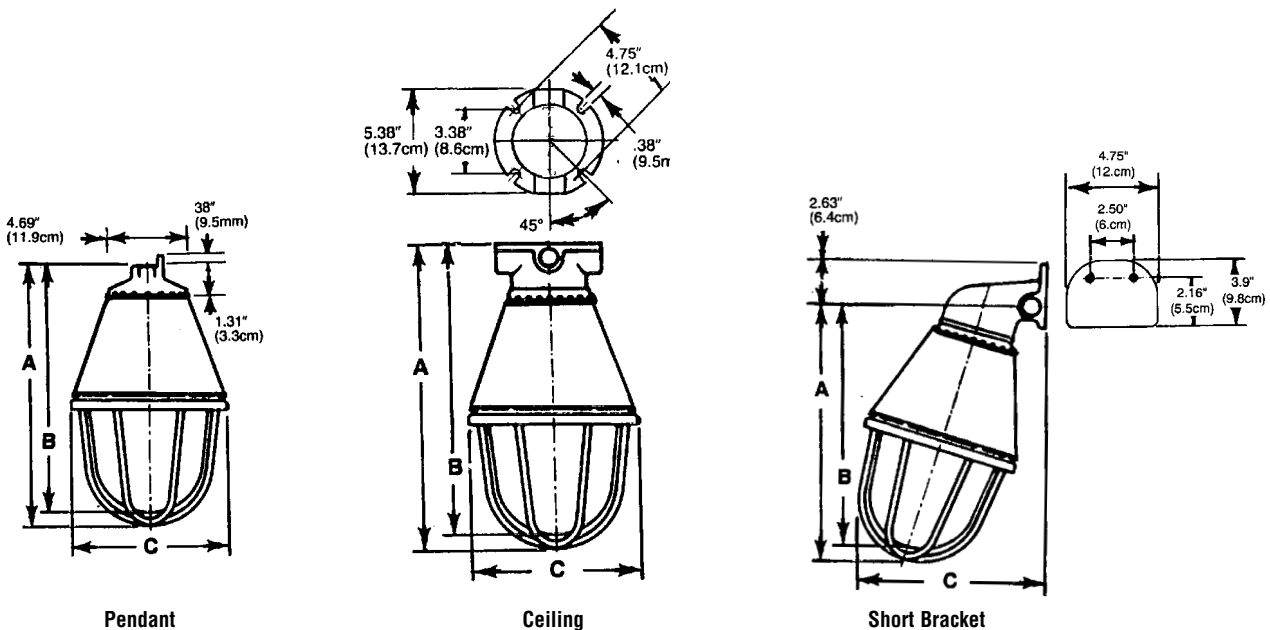

Dimensions in Inches

Size (Watts)	Pendant			Ceiling			Short Bracket		
	A	B	C	A	B	C	A	B	C
60-200	13.69	13.13	7.06	16.50	15.94	7.06	15.00	14.44	9.50
200-300	14.75	13.69	8.81	17.56	16.50	8.81	16.00	15.44	10.38