

Industrial Mercmaster™ LED Low Profile Luminaires with Emergency Battery Backup For Ordinary Locations

NEC/CEC:
cCSAus Listed
Type 3R, 4, 4X
IP66/67

NEC/CEC:
Simultaneous Exposure
Suitable for Use in Wet Locations
American Bureau of Shipping (ABS) Certified

Applications

- Enclosed and gasketed fixtures suitable for use in:
 - A wide range of industrial, chemical processing and other areas where flammable gases, vapors and combustible dusts are present including simultaneous exposure
 - Marine and wet locations
 - Areas of low clearance, low ceiling heights or where fixture weights must be minimized
- Typical applications include:
 - Walkways/catwalks
 - Stairwells
 - Tunnels
 - Pipe racks
 - Vessel lighting
 - Processing areas

Features

- Three light output levels for retrofit of HID fixtures up to 175 W.

Nominal Lumens ①	HID Equivalent	Model Number
3300	70-100W	IMLLED2
4400	100-150W	IMLLED3
5500	150-175W	IMLLED4

Nominal lumen value for 5000K CCT, clear glass globe.
Detailed lumen information is provided in tables.

- Choice of color temperature (CCT): 5000K cool white, 4000K neutral white or 3000K warm white.
- Seven standard mounting hood designs allow for mounting in any location. Uses same mounting hoods as Mercmaster™ III, Mercmaster™ Premium LED and Mercmaster™ LED Generation 3.
- Customize to the application requirements with three different field replaceable globe options: clear and diffused polycarbonate and clear glass.
- Provides up to 1400 lumens illumination for 90 minutes of emergency lighting with clear lens or 800 lumens illumination for 180 minutes of emergency lighting.
- Functional diagnostic test self-initiates every 14 days after initial start up.
- Duration test is automatically performed once per year.
- Green and Red LED lamps indicate charging status and provide fault warning.
- Simple quick disconnect connector disconnects power between LEDs and battery management module to allow maintenance.
- Compact light weight low profile design is suited for low mounting heights.
- Hinge has high lip for added safety during installation and servicing. Hinge and bolt construction assures 360° compression at all points on fixture housing gasket for positive sealing. Swing away design of captive bolt and nut simplifies servicing.
- Standard 6 kV surge protection.



- Ambient Temperature: BU: -20 °C to +55 °C (-4 °F to +131 °F)
- Standard screw-type terminal block can accept UL/CSA 26-10 AWG wire.
- Heavy duty, high temperature silicone rubber gaskets.
- LED L70 rated at 109,000 Hours @ +25 °C (+77 °C).
- Field replaceable globes, battery management module (BMM), battery pack and LED driver.
- Rugged housing with superior thermal design translates to long luminaire life.
- Retrofit adapters for Crouse Hinds™ hood available. See Mercmaster CH Adapters.

Options

- Glass globe guard available, purchase separately.

Standard Materials

- Mounting hoods and bodies: cast copperfree (4/10 of 1% max.) aluminum
- All hardware and catch assemblies: stainless steel
- Globe: polycarbonate or glass
- Glass and polycarbonate globe guard: stainless steel wire
- Reflector: fiberglass reinforced white polyester

Standard Finishes

- Mounting hoods, bodies and glass refractor guard: gray epoxy powder coat finish, electrostatically applied for complete uniform protection

NEC/CEC Certifications and Compliances

- UL Standard: UL 1598, Third Edition; UL 8750, Second Edition; UL 924, Tenth Edition
- CSA Standard: C22.2 No. 250.0-.00; C22.2 No. 250.13-2017; C22.2 No. 141-15
- cCSAus Listed: Master contract 164460
- Ambient Temperature:
120-277 Volts: -20 °C up to +55 °C (-4 °F up to +131 °F)

Related Products

- Mercmaster LED Mounting Adapters
- Mercmaster LED Low Profile Luminaires

DesignLights™ Consortium

- Check DLC QPL for current list of products.

① Nominal Lumen value for 5000K CCT, clear glass globe. Detailed lumen information is provided in tables.

Industrial Mercmaster™ LED Low Profile Luminaires with Emergency Battery Backup For Ordinary Locations

NEC/CEC:
CCSAus Listed
Type 3R, 4, 4X
IP66/67

NEC/CEC:
Simultaneous Exposure
Suitable for Use in Wet Locations
American Bureau of Shipping (ABS) Certified

Illustrated Features

Heatsink

Reliable heat transfer via the cast, epoxy powder coat aluminum body. Provides maximum heat dissipation from the LED assembly to the outside environment.

Reflectors and Visors

Reflectors are thick, tough fiberglass reinforced white polyester. Visor is aluminum with electrostatically applied, gray epoxy powder coat finish. Quickly attach either accessory to luminaire with furnished stainless steel screws.



Driver Assembly

Utilizing non-sparking components avoiding the ignition of gases or vapors that may be present. Field Replaceable Battery Management Module and Battery pack available.



Mounting Hood and Globe Gaskets

Silicone rubber gaskets seal out moisture, dirt and dust. Stays flexible, withstands extreme temperatures. Closure design assures uniform gasket compression.

Terminal Blocks

A seven-point terminal block is provided to facilitate wiring. Terminal block accommodates wire size ranging from 24-10 AWG.

Stainless Steel Latch Assembly

Captive, stainless steel latch assembly bolt and nut closes securely, resists attack of corrosive atmospheres. Swing-away design simplifies servicing.



Epoxy Finish

Fixture housing, hoods and guards are copperfree aluminum with triple protection epoxy powder coat finish.

Quick Disconnect

Simple quick disconnect connector disconnects power between LEDs and battery management module to allow maintenance.

"Safety" Cable

Safety cable option threads through the fixture housing for additional safety.

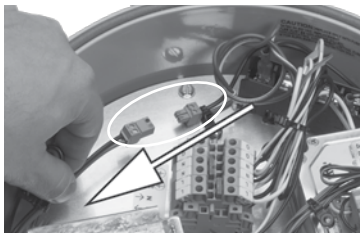

LED/AREA: NEC/CEC EMERGENCY

APPLETON™

Industrial Mercmaster™ LED Low Profile Luminaires with Emergency Battery Backup For Ordinary Locations

NEC/CEC:
CCSAus Listed
Type 3R, 4, 4X
IP66/67

NEC/CEC:
Simultaneous Exposure
Suitable for Use in Wet Locations
American Bureau of Shipping (ABS) Certified

Mercmaster™ LED Low Profile Family Tree

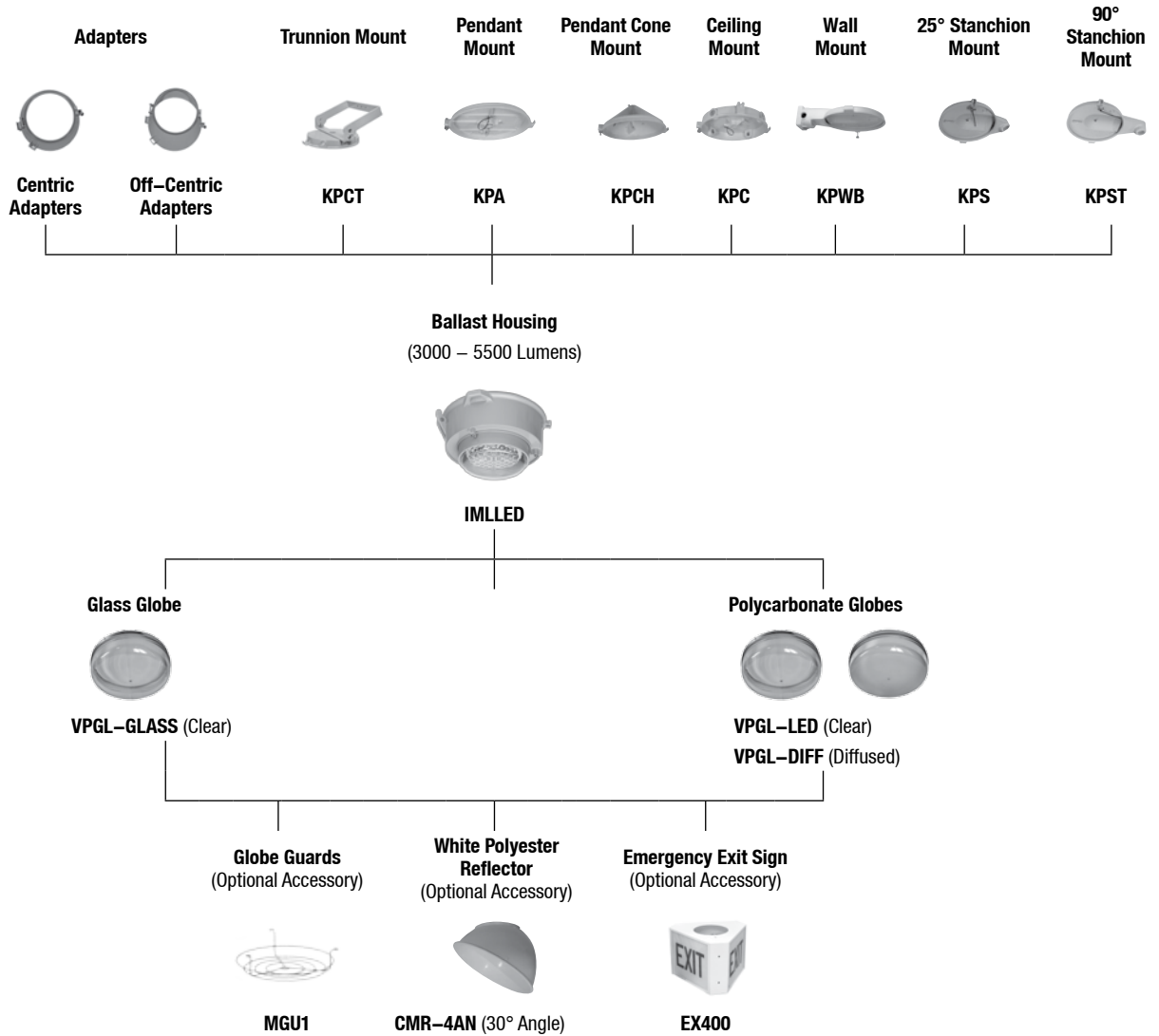

LED / AREA: NEC / CEC: EMERGENCY

APPLETON™

① Certified for cCSAus only.

Industrial Mercmaster™ LED Low Profile Luminaires with Emergency Battery Backup For Ordinary Locations

NEC/CEC:
CSAUs Listed
Type 3R, 4, 4X
IP66/67

NEC/CEC:
Simultaneous Exposure
Suitable for Use in Wet Locations
American Bureau of Shipping (ABS) Certified

Order using catalog numbering guides below or select catalog number from tables on following pages.

Catalog Numbering Guide For Ordinary Locations:

IMLLED	A	3	2	C	P5	BU	H
IMLLED - Industrial Mercmaster™ LED Low Profile Series with Emergency Battery Backup Series		Lumen Output ③: 2 - 3K Lumens 3 - 4K Lumens 4 - 5K Lumens		Color Temperature: C - Cool 5000K CCT N - Neutral 4000K CCT W - Warm 3000K CCT		Voltage: BU - 120-277 Vac, 50/60Hz	
			Hub Size: 2 - 3/4" NPT 3 - 1" NPT 4 - 1-1/4" NPT stanchion 5 - 1-1/2" NPT stanchion 6 - M20 Metric hub Blank - No hub if using adapter or ordering ballast housing only (no mounting hood)				Emergency: H - 90 Minutes
	Mounting: A - Pendant C - Ceiling D - Pendant Cone Hood R - 90° Stanchion ② S - 25° Stanchion ② T - Trunnion W - Wall X - Crouse Hinds™ Adapter, Ceiling or Pendant ① Y - Crouse Hinds™ Adapter, Stanchion or Wall ① Blank - No Mounting Hood			Globe Material ④: P5 - NEMA Type V Clear Polycarbonate Globe D5 - NEMA Type V Diffused Polycarbonate Globe G5 - NEMA Type V Glass Globe			

LED/AREA: NEC/CEC EMERGENCY

APPLETON™

① Certified for cCSAUs only.
② 3/4" NPT, 1" NPT and Metric M20 hub entries not offered in this mounting option.
③ For specific lumen output information, see Lamp Comparison Chart.
④ Guards for the glass globes are ordered separately. See the Accessories for more information.

Industrial Mercmaster™ LED Low Profile Luminaires with Emergency Battery Backup For Ordinary Locations

NEC/CEC:
CCSAus Listed
Type 3R, 4, 4X
IP66/67

NEC/CEC:
Simultaneous Exposure
Suitable for Use in Wet Locations
American Bureau of Shipping (ABS) Certified

Electrical Specification

Model	Line Current Amps (50/60Hz)	Input Power	Power Factor	THD	Lumens ①			CRI ②	Color Temp CCT	Equivalent HID Luminaire
					Polycarbonate Clear Globe	Polycarbonate Diffused Globe	Glass Clear Globe			
NEMA Type V										
IMLLED2	.27 @120V .13 @277V	33.0	> .94	< 15%	3200	3100	3300	>70	5000K	70-100 W
IMLLED3	.33 @120V .16 @277V	40.0	> .96	< 15%	4200	4100	4400	>70	5000K	100-150 W
IMLLED4	.42 @120V .2 @277V	49.0	> .97	< 15%	5300	5150	5500	>70	5000K	150-175 W
90 Minute Emergency Mode										
IMLLED2					1400	1350	1450			
IMLLED3					1400	1350	1450			
IMLLED4					1400	1350	1450			
Model	Line Current Amps (50/60Hz)	Input Power	Power Factor	THD	Lumens ①			CRI ②	Color Temp CCT	Equivalent HID Luminaire
					Polycarbonate Clear Globe	Polycarbonate Diffused Globe	Glass Clear Globe			
NEMA Type V										
MLLED2	.27 @120V .13 @277V	33.0	> .94	< 15%	3200	3100	3100	>70	4000K	70-100 W
MLLED3	.33 @120V .16 @277V	40.0	> .96	< 15%	4200	3900	4200	>70	4000K	100-150 W
MLLED4	.42 @120V .2 @277V	49.0	> .97	< 15%	5000	4900	5200	>70	4000K	150-175 W
90 Minute Emergency Mode										
IMLLED2					1270	1200	1330			
IMLLED3					1270	1200	1330			
IMLLED4					1270	1200	1330			
Model	Line Current Amps (50/60Hz)	Input Power	Power Factor	THD	Lumens ①			CRI ②	Color Temp CCT	Equivalent HID Luminaire
					Polycarbonate Clear Globe	Polycarbonate Diffused Globe	Glass Clear Globe			
NEMA Type V										
IMLLED2	.27 @120V .13 @277V	33.0	> .9	< 15%	3000	2900	3100	>70	3000K	70-100 W
IMLLED3	.33 @120V .16 @277V	40.0	> .9	< 15%	3900	3800	4100	>70	3000K	100-150 W
IMLLED4	.42 @120V .2 @277V	49.0	> .9	< 15%	4900	4800	5000	>70	3000K	150-175 W
90 Minute Emergency Mode										
IMLLED2					1150	1100	1200			
IMLLED3					1150	1100	1200			
IMLLED4					1150	1100	1200			

① All lumen values are typical (tolerance +/- 10%).
② 70 minimum.

Industrial Mercmaster™ LED Low Profile Luminaires with Emergency Battery Backup For Ordinary Locations

NEC/CEC:
CCSAus Listed
Type 3R, 4, 4X
IP66/67

NEC/CEC:
Simultaneous Exposure
Suitable for Use in Wet Locations
American Bureau of Shipping (ABS) Certified

Automatic Testing System (ATS)	
Functional	Full Duration
Starts within 24 to 45 hours after the initial powerup of the module	Starts within 5 to 26 days after the initial power of the module
Occurs every 14 days after the initial aforementioned functional test	Occurs every 364 days after the initial aforementioned functional test
Lasts for 5 minutes	Lasts for the full duration of the rated emergency period

At the completion of functional and full duration tests, LED indicator will display the status of the emergency luminaire when AC is present

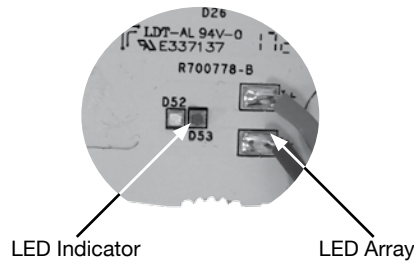

LED Signals		
Color	Timing	Description
Green	1 sec ON: 1 sec OFF	Normal charging ok, Battery not yet fully charged, No fault detected, Testing ok
Green	0.25 sec ON: 0.25 sec OFF	Functional / Duration Self-Test on-going
Green	Steady ON	Charging ok, Battery fully charged, No fault detected, Testing ok
Red	1 sec ON: 1 sec OFF	Fault condition. Installation issue. Battery is reverse, not connected or shorted. Functional test failure, full duration test failure
LED Indicators OFF, LED Array ON	LED Indicator Lights (Red and Green) OFF	No AC, Emergency mode ON



LED/AREA: NEC/CEC EMERGENCY

APPLETON™

Industrial Mercmaster™ LED Low Profile Luminaires with Emergency Battery Backup For Ordinary Locations

NEC/CEC:
CCSAus Listed
Type 3R, 4, 4X
IP66/67

NEC/CEC:
Simultaneous Exposure
Suitable for Use in Wet Locations
American Bureau of Shipping (ABS) Certified

	Hub Size	Lumen Level	With Type V Polycarbonate Globe ①	With Type V Polycarbonate Diffused Globe ①	Glass Globe ① ②
Pendant — One Hub					
	3/4	3K	IMMLEDA22XP5BUH	IMMLEDA22XD5BUH	IMMLEDA22XG5BUH
	3/4	4K	IMMLEDA32XP5BUH	IMMLEDA32XD5BUH	IMMLEDA32XG5BUH
	3/4	5K	IMMLEDA42XP5BUH	IMMLEDA42XD5BUH	IMMLEDA42XG5BUH
	1	3K	IMMLEDA23XP5BUH	IMMLEDA23XD5BUH	IMMLEDA23XG5BUH
	1	4K	IMMLEDA33XP5BUH	IMMLEDA33XD5BUH	IMMLEDA33XG5BUH
	1	5K	IMMLEDA43XP5BUH	IMMLEDA43XD5BUH	IMMLEDA43XG5BUH
Ceiling — Five Hubs, Four Close-up Plugs					
	3/4	3K	IMMLEDC22XP5BUH	IMMLEDC22XD5BUH	IMMLEDC22XG5BUH
	3/4	4K	IMMLEDC32XP5BUH	IMMLEDC32XD5BUH	IMMLEDC32XG5BUH
	3/4	5K	IMMLEDC42XP5BUH	IMMLEDC42XD5BUH	IMMLEDC42XG5BUH
	1	3K	IMMLEDC23XP5BUH	IMMLEDC23XD5BUH	IMMLEDC23XG5BUH
	1	4K	IMMLEDC33XP5BUH	IMMLEDC33XD5BUH	IMMLEDC33XG5BUH
	1	5K	IMMLEDC43XP5BUH	IMMLEDC43XD5BUH	IMMLEDC43XG5BUH
Pendant Cone — One Hub, Rigid Mounting					
	3/4	3K	IMMLEDD22XP5BUH	IMMLEDD22XD5BUH	IMMLEDD22XG5BUH
	3/4	4K	IMMLEDD32XP5BUH	IMMLEDD32XD5BUH	IMMLEDD32XG5BUH
	3/4	5K	IMMLEDD42XP5BUH	IMMLEDD42XD5BUH	IMMLEDD42XG5BUH
	1	3K	IMMLEDD23XP5BUH	IMMLEDD23XD5BUH	IMMLEDD23XG5BUH
	1	4K	IMMLEDD33XP5BUH	IMMLEDD33XD5BUH	IMMLEDD33XG5BUH
	1	5K	IMMLEDD43XP5BUH	IMMLEDD43XD5BUH	IMMLEDD43XG5BUH

LED/AREA: NEC/CEC EMERGENCY

APPLETON





① X = Color temperature; C = Cool, 5000K CCT, N = Neutral, 4000K CCT, W = Warm, 3000K CCT. **MLLEDW43CP5BUH**.

② Guards are available for fixtures with glass or polycarbonate globe. See following pages for accessory ordering information.

Industrial Mercmaster™ LED Low Profile Luminaires with Emergency Battery Backup For Ordinary Locations

NEC/CEC:
CCSAus Listed
Type 3R, 4, 4X
IP66/67

NEC/CEC:
Simultaneous Exposure
Suitable for Use in Wet Locations
American Bureau of Shipping (ABS) Certified

	Hub Size	Lumen Level	With Type V Polycarbonate Globe ①	With Type V Polycarbonate Diffused Globe ①	Glass Globe ①②
90° Stanchion — One Hub					
	1 - 1/4	3K	IMMLEDR24XP5BUH	IMMLEDR24XD5BUH	IMMLEDR24XG5BUH
	1 - 1/4	4K	IMMLEDR34XP5BUH	IMMLEDR34XD5BUH	IMMLEDR34XG5BUH
	1 - 1/4	5K	IMMLEDR44XP5BUH	IMMLEDR44XD5BUH	IMMLEDR44XG5BUH
	1 - 1/2	3K	IMMLEDR25XP5BUH	IMMLEDR25XD5BUH	IMMLEDR25XG5BUH
	1 - 1/2	4K	IMMLEDR35XP5BUH	IMMLEDR35XD5BUH	IMMLEDR35XG5BUH
	1 - 1/2	5K	IMMLEDR45XP5BUH	IMMLEDR45XD5BUH	IMMLEDR45XG5BUH
25° Stanchion — One Hub					
	1 - 1/4	3K	IMMLEDS24XP5BUH	IMMLEDS24XD5BUH	IMMLEDS24XG5BUH
	1 - 1/4	4K	IMMLEDS34XP5BUH	IMMLEDS34XD5BUH	IMMLEDS34XG5BUH
	1 - 1/4	5K	IMMLEDS44XP5BUH	IMMLEDS44XD5BUH	IMMLEDS44XG5BUH
	1 - 1/2	3K	IMMLEDS25XP5BUH	IMMLEDS25XD5BUH	IMMLEDS25XG5BUH
	1 - 1/2	4K	IMMLEDS35XP5BUH	IMMLEDS35XD5BUH	IMMLEDS35XG5BUH
	1 - 1/2	5K	IMMLEDS45XP5BUH	IMMLEDS45XD5BUH	IMMLEDS45XG5BUH
Wall — Five Hubs, Four Close-Up Plugs					
	3/4	3K	IMMLEDW22XP5BUH	IMMLEDW22XD5BUH	IMMLEDW22XG5BUH
	3/4	4K	IMMLEDW32XP5BUH	IMMLEDW32XD5BUH	IMMLEDW32XG5BUH
	3/4	5K	IMMLEDW42XP5BUH	IMMLEDW42XD5BUH	IMMLEDW42XG5BUH
	1	3K	IMMLEDW23XP5BUH	IMMLEDW23XD5BUH	IMMLEDW23XG5BUH
	1	4K	IMMLEDW33XP5BUH	IMMLEDW33XD5BUH	IMMLEDW33XG5BUH
	1	5K	IMMLEDW43XP5BUH	IMMLEDW43XD5BUH	IMMLEDW43XG5BUH
Trunnion — One Hub					
	3/4	3K	IMMLEDT22XP5BUH	IMMLEDT22XD5BUH	IMMLEDT22XG5BUH
	3/4	4K	IMMLEDT32XP5BUH	IMMLEDT32XD5BUH	IMMLEDT32XG5BUH
	3/4	5K	IMMLEDT42XP5BUH	IMMLEDT42XD5BUH	IMMLEDT42XG5BUH
	1	3K	IMMLEDT23XP5BUH	IMMLEDT23XD5BUH	IMMLEDT23XG5BUH
	1	4K	IMMLEDT33XP5BUH	IMMLEDT33XD5BUH	IMMLEDT33XG5BUH
	1	5K	IMMLEDT43XP5BUH	IMMLEDT43XD5BUH	IMMLEDT43XG5BUH

LED/AREA: NEC/CEC EMERGENCY

APPLETON™

① X = Color temperature; C = Cool, 5000K CCT, N = Neutral, 4000K CCT, W = Warm, 3000K CCT. Example: **MLEDW43WP5BUH**.

② Guards are available for fixtures with glass or polycarbonate globe. See following pages for accessory ordering information.

Industrial Mercmaster™ LED Low Profile Luminaires with Emergency Battery Backup For Ordinary Locations

NEC/CEC:
CCSAus Listed
Type 3R, 4, 4X
IP66/67







NEC/CEC:
Simultaneous Exposure
Suitable for Use in Wet Locations
American Bureau of Shipping (ABS) Certified

Fixture Unit — Ballast Body and Globe



Lumen Level	LED Wattage	Light Level Equivalent	NEMA Type	Catalog Number ①		
				With Type V Polycarbonate Globe ①②	With Type V Polycarbonate Diffused Globe ①②	Glass Globe ①②③
NEC/CEC Certified Fixture Housing - For Ordinary Locations						
3K	33	70-100W HPS	Type V	IMMLED2XP5BUH	IMMLED2XD5BUH	IMMLED2XG5BUH
4K	40	100-150W HPS	Type V	IMMLED3XP5BUH	IMMLED3XD5BUH	IMMLED3XG5BUH
5K	49	150-175W HPS	Type V	IMMLED4XP5BUH	IMMLED4XD5BUH	IMMLED4XG5BUH

Mounting Hoods

	Description	Hub Size	Catalog Number
	One Hub	3/4	KPA-75
		1	KPA-100
		M20	KPA-M20
	One Hub, Rigid Mounting	3/4	KPCH-75
		1	KPCH-100
		M20	KPCH-M20
	Five Hubs, Four Close-Up Plugs	3/4	KPCT-75
		1	KPCT-100
	Five Hubs, Four Close-Up Plugs	3/4	KPC-75
		1	KPC-100
		M20	KPC-M20
	Five Hubs, Four Close-Up Plugs	3/4	KPWB-75
		1	KPWB-100
		M20	KPWB-M20
	One Hub	1-1/4	KPS-125
		1-1/2	KPS-150
	One Hub	1-1/4	KPST-125
		1-1/2	KPST-150

① For 120-277 Vac, use suffix **-BU**.

② **X** = Color temperature; **C** = Cool, 5000K CCT, **N** = Neutral, 4000K CCT, **W** = Warm, 3000K CCT. Example: **MLLED2CP5BUH**.

③ Guards are available for fixtures with glass globe. See following pages for accessory ordering information.

④ Must be ordered separately.

LED/AREA: NEC/CEC EMERGENCY



APPLETON™

Industrial Mercmaster™ LED Low Profile Luminaires with Emergency Battery Backup For Ordinary Locations





NEC/CEC:
CCSAus Listed
Type 3R, 4, 4X
IP66/67

NEC/CEC:
Simultaneous Exposure
Suitable for Use in Wet Locations
American Bureau of Shipping (ABS) Certified

Replacement Parts

	Description	Catalog Number
Globes and Gaskets		
	Clear Globe (polycarbonate)	VPGL-LED
	Diffused Globe (polycarbonate)	VPGL-DIFF
	Glass Globe	VPGL-GLASS

Accessories

	Description	Catalog Number
White Polyester Reflectors		
 30° Angle	30° Angle	CMR-4AN
Exit Sign		
	Emergency Exit sign	EXR-400
Guards		
 Glass Globe Guard	Glass Globe Guard	MGU1
Safety Cable		
	Stainless steel	LEDSC
Replacement Battery Pack		BPMLLED
Replacement Battery Management Module		BMMLLED
Replacement Fuse (Emergency system)		MLF3

Replacement Drivers and Battery Management Module with Battery

	Voltage	Driver Wattage	Luminaire Model	Constant Current Settings	Catalog Number
	BU	50 Watt	MLLED2	415mA	APMS050C135UD41
	BU	50 Watt	MLLED3	550mA	APMS050C135UD55
	BU	50 Watt	MLLED4	690mA	APMS050C135UD69

LED/AREA: NEC/CEC EMERGENCY

APPLETON™

Industrial Mercmaster™ LED Low Profile Luminaires with Emergency Battery Backup For Ordinary Locations

NEC/CEC:
CCSAus Listed
Type 3R, 4, 4X
IP66/67

NEC/CEC:
Simultaneous Exposure
Suitable for Use in Wet Locations
American Bureau of Shipping (ABS) Certified

Dimensions in Millimeters (Inches)

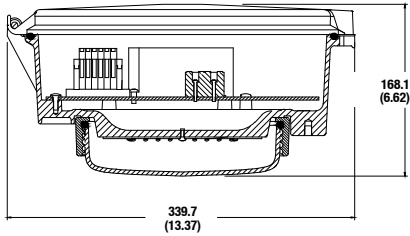

Pendant Mount

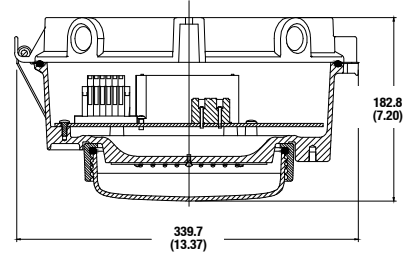

Ceiling Mount

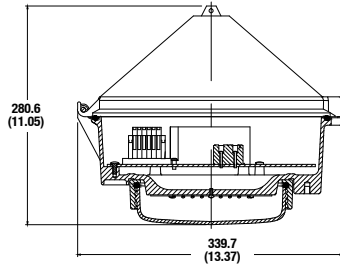

Pendant Cone Mount

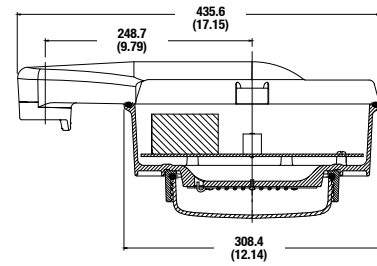

90° Stanchion Mount

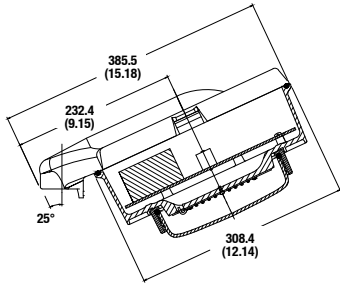

25° Stanchion Mount

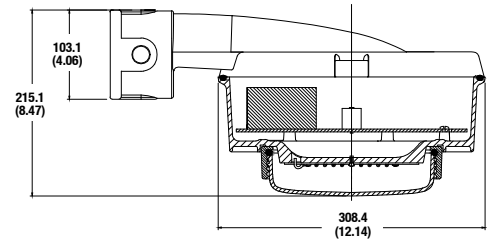

Wall Mount

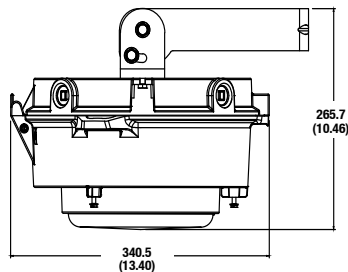

Trunnion Mount

LED / AREA: NEC/CEC EMERGENCY

APPLETON

Industrial Mercmaster™ LED Low Profile Luminaires with Emergency Battery Backup For Ordinary Locations

NEC/CEC:
CCSAus Listed
Type 3R, 4, 4X
IP66/67

NEC/CEC:
Simultaneous Exposure
Suitable for Use in Wet Locations
American Bureau of Shipping (ABS) Certified

Dimensions in Millimeters (Inches)

With Polycarbonate Globe

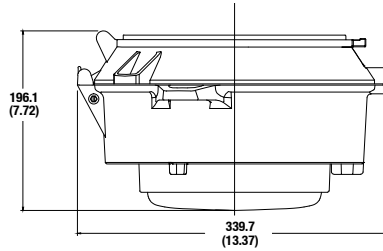

CH-Adapter-Centric

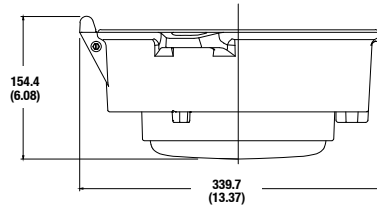

Driver Housing

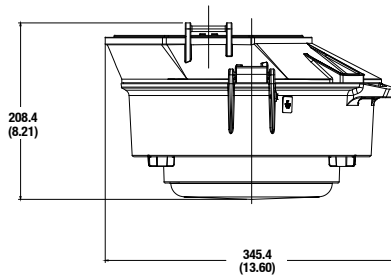

CH-Adapter Off-Centric

Mercmaster LED Low Profile Fixture and Mounting Hood Weights

Description	Weight kg (lb)
Fixture Unit	5.8 (13.80)
Pendant Mounting Hood	1.0 (2.25)
Pendant Cone Mounting Hood	1.1 (2.50)
Ceiling Mounting Hood	1.4 (3.00)
Wall Mounting Hood	1.8 (4.00)
25° Stanchion Mounting Hood	1.5 (3.25)
90° Stanchion Mounting Hood	1.7 (3.75)
CH-Adapter-Centric	0.9 (2.00)
CH-Adapter-Off-Centric	0.9 (2.00)

LED/AREA: NEC/CEC EMERGENCY

APPLETON™

Industrial Mercmaster™ LED Low Profile Luminaires with Emergency Battery Backup For Ordinary Locations

NEC/CEC:
CCSAus Listed
Type 3R, 4, 4X
IP66/67

NEC/CEC:
Simultaneous Exposure
Suitable for Use in Wet Locations
American Bureau of Shipping (ABS) Certified

Photometric Data — DATA SHOWN IS ABSOLUTE

Type V, Clear Polycarbonate 5000K CCT
REPORT NUMBER: IMLLED2CP5BUH+EMR

Luminaire Lumens 1,404

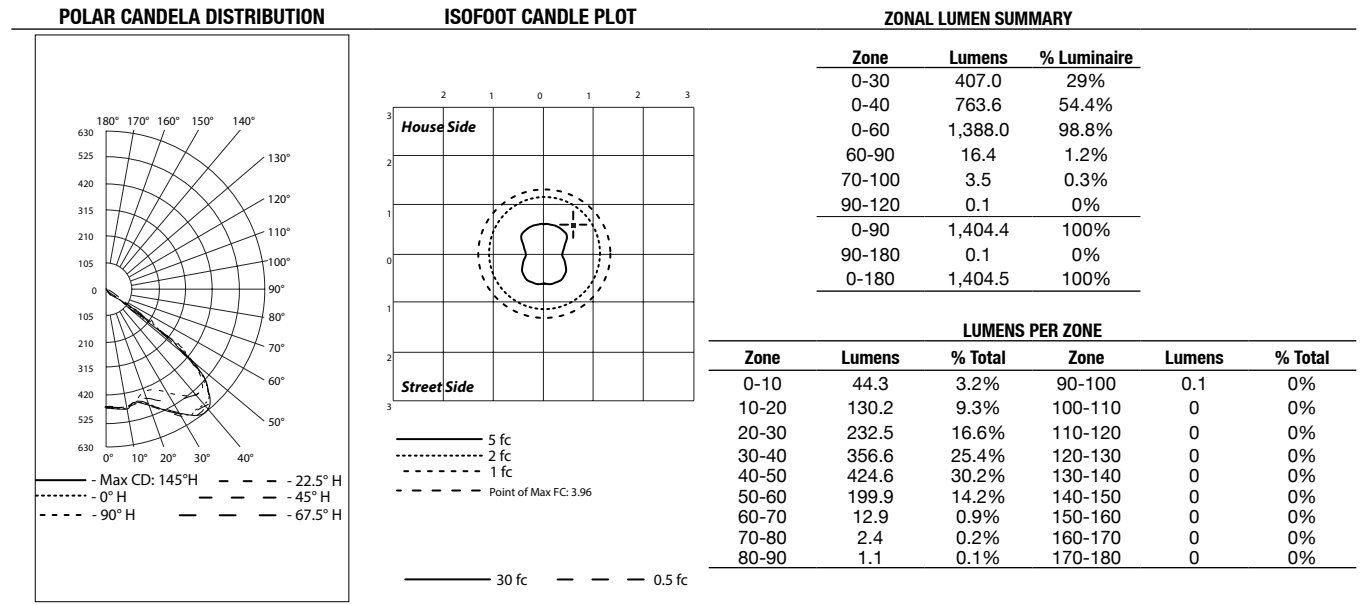

Type V, Diffused Polycarbonate 5000K CCT
REPORT NUMBER: IMLLED2CD5BUH+EMR

Luminaire Lumens 1,369

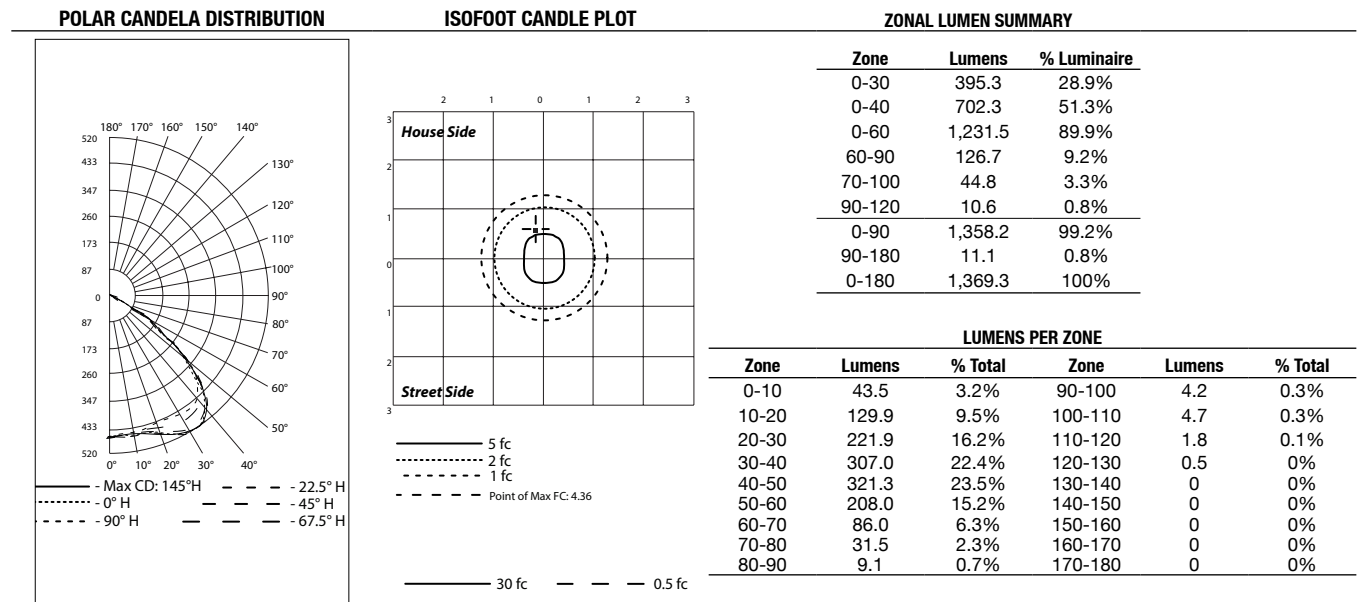

Industrial Mercmaster™ LED Low Profile Luminaires with Emergency Battery Backup For Ordinary Locations

NEC/CEC:
CCSAus Listed
Type 3R, 4, 4X
IP66/67

NEC/CEC:
Simultaneous Exposure
Suitable for Use in Wet Locations
American Bureau of Shipping (ABS) Certified

Photometric Data — DATA SHOWN IS ABSOLUTE

Type V, Clear Glass 5000K CCT

REPORT NUMBER: IMLLED2CG5BUH+EMR

Luminaire Lumens 1,460

POLAR CANDELA DISTRIBUTION

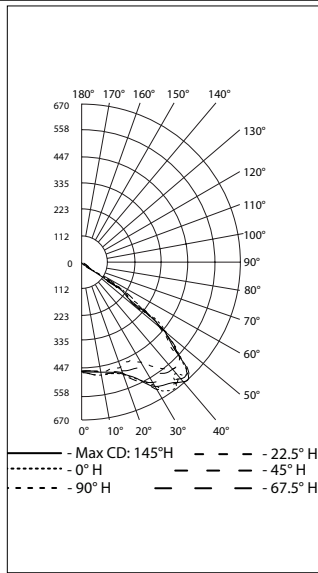

ISOFOOT CANDLE PLOT

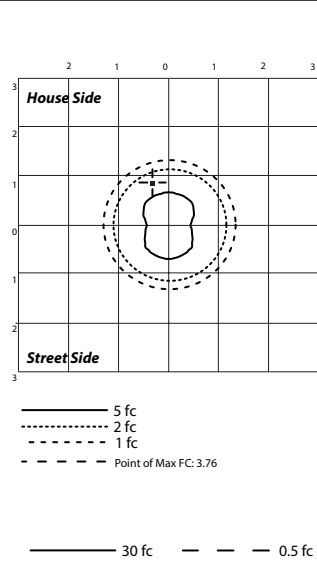

ZONAL LUMEN SUMMARY

Zone	Lumens	% Luminaire
0-30	420.1	28.8%
0-40	792.8	54.3%
0-60	1,443.4	98.8%
60-90	16.8	1.1%
70-100	3.0	0.2%
90-120	0.1	0%
0-90	1,460.2	100%
90-180	0.1	0%
0-180	1,460.2	100%

LUMENS PER ZONE

Zone	Lumens	% Total	Zone	Lumens	% Total
0-10	44.3	3.0%	90-100	0.1	0%
10-20	133.9	9.2%	100-110	0	0%
20-30	242.0	16.6%	110-120	0	0%
30-40	372.6	25.5%	120-130	0	0%
40-50	444.7	30.5%	130-140	0	0%
50-60	205.9	14.1%	140-150	0	0%
60-70	13.8	0.9%	150-160	0	0%
70-80	2.1	0.1%	160-170	0	0%
80-90	0.8	0.1%	170-180	0	0%

Type V, Clear Polycarbonate 4000K CCT

REPORT NUMBER: IMLLED4NG5BUH+EMR

Luminaire Lumens 1,330

POLAR CANDELA DISTRIBUTION

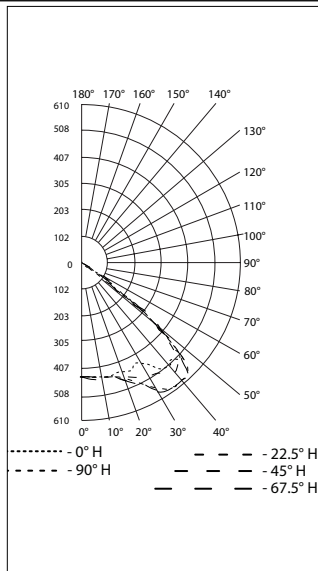

ISOFOOT CANDLE PLOT

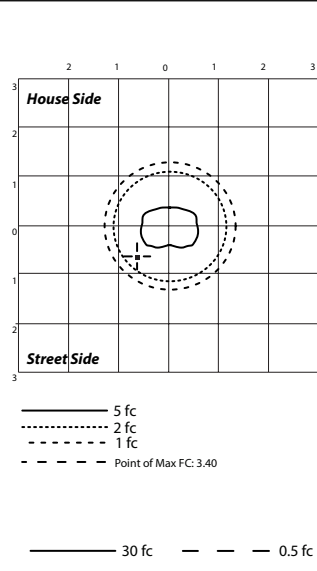

ZONAL LUMEN SUMMARY

Zone	Lumens	% Luminaire
0-30	392.5	29.5%
0-40	733.5	55.1%
0-60	1,315.4	98.9%
60-90	15.0	1.1%
70-100	2.6	0.2%
90-120	0	0%
0-90	1,330.4	100%
90-180	0	0%
0-180	1,330.4	100%

LUMENS PER ZONE

Zone	Lumens	% Total	Zone	Lumens	% Total
0-10	41.9	3.1%	90-100	0	0%
10-20	125.8	9.5%	100-110	0	0%
20-30	224.8	16.9%	110-120	0	0%
30-40	341.0	25.6%	120-130	0	0%
40-50	399.6	30.0%	130-140	0	0%
50-60	182.3	13.7%	140-150	0	0%
60-70	12.4	0.9%	150-160	0	0%
70-80	1.9	0.1%	160-170	0	0%
80-90	0.7	0.1%	170-180	0	0%

LED/AREA: NEC/CEC EMERGENCY

APPLETON™

Industrial Mercmaster™ LED Low Profile Luminaires with Emergency Battery Backup For Ordinary Locations

NEC/CEC:
CCSAus Listed
Type 3R, 4, 4X
IP66/67

NEC/CEC:
Simultaneous Exposure
Suitable for Use in Wet Locations
American Bureau of Shipping (ABS) Certified

Photometric Data — DATA SHOWN IS ABSOLUTE

Type V, Clear Glass 4000K CCT

REPORT NUMBER: IMLLED4WG5BUH+EMR

Luminaire Lumens 1,207

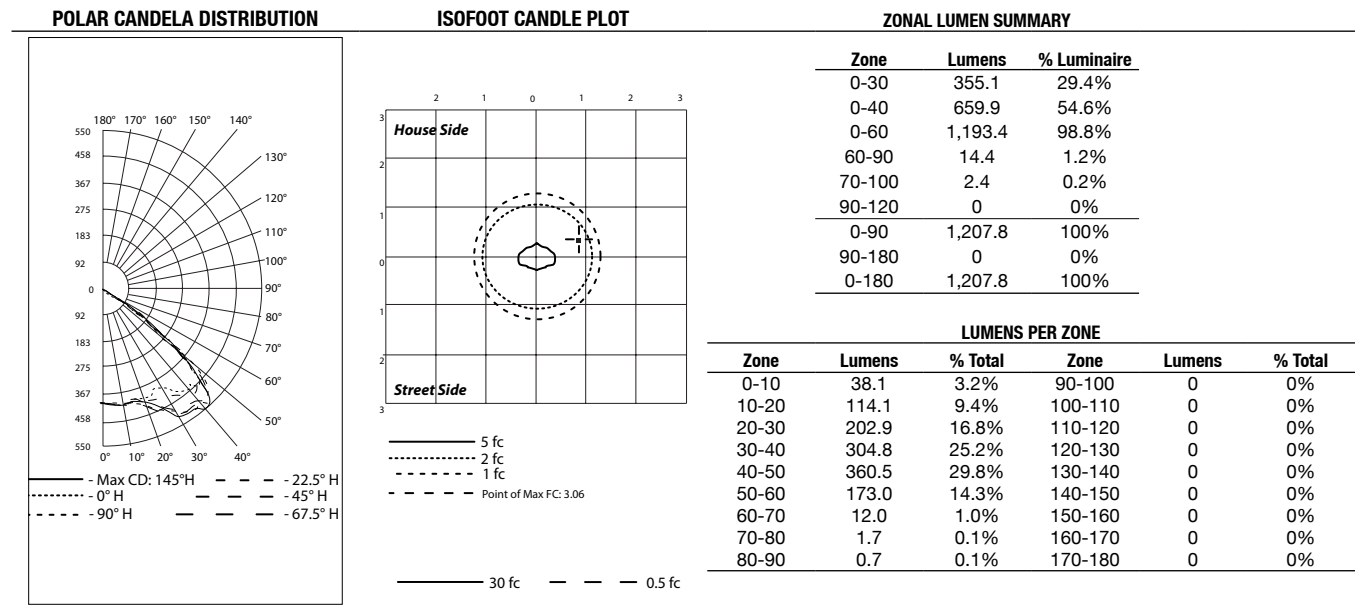

LED / AREA: NEC/CEC EMERGENCY

APPLETON™