

Multifunction Bloc Solution



- Fully integrated in Burkert's Process Control Systems
- Quality certifications **FDA** , USP

Type 2034 can be combined with...



Type 8691
Control Head



Type 8686
Control Head
Robolux

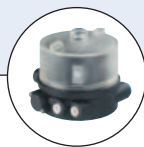

Type 8690
Pneum. control unit
with feedback



Type 8685
Control unit
Robolux

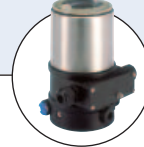

Type 8692
Positioner Top-
Control continuous



Stroke limitation
Min./max. stroke
limitation

The Bürkert bloc configurations are designed for the control of ultrapure, sterile, aggressive or abrasive fluids. They are designed to be fully drainable and can be operated by either pneumatic actuator or manual handwheel.

Available accessories include Positioner/PID controllers, stroke limiters, electrical feedback, pneumatic pilot valves.



Technical data																
Orifice	DN08 to DN100															
Body material	<ul style="list-style-type: none"> ▪ Stainless steel 1.4435 / 316L ▪ Stainless steel 1.4435 acc. to BN2 / ASME BPE, Fe < 0.5% ▪ Other on request 															
Port connections	<ul style="list-style-type: none"> ▪ DIN EN ISO 1127 / ISO 4200 / DIN 11866 Serie B ▪ DIN 11850 Serie 2 / DIN 11866 Serie A ▪ ASME BPE / DIN 11866 Serie C ▪ DIN 32676 Serie A (DIN tube) ▪ DIN 32676 Serie B (ISO tube) ▪ ASME BPE 															
Weld end																
Clamp																
Surface finish	<table border="1"> <thead> <tr> <th></th> <th>Ra [µm]</th> <th>Ra [µlnch]</th> </tr> </thead> <tbody> <tr> <td>internal</td> <td></td> <td>internal</td> </tr> <tr> <td>Mechanical polished</td> <td>0.6</td> <td>25</td> </tr> <tr> <td>Electro polished</td> <td>0.4</td> <td>15</td> </tr> <tr> <td>Other on request</td> <td></td> <td>Other on request</td> </tr> </tbody> </table>		Ra [µm]	Ra [µlnch]	internal		internal	Mechanical polished	0.6	25	Electro polished	0.4	15	Other on request		Other on request
	Ra [µm]	Ra [µlnch]														
internal		internal														
Mechanical polished	0.6	25														
Electro polished	0.4	15														
Other on request		Other on request														
Seal materials	EPDM, PTFE/EPDM, advanced PTFE/EPDM, FKM															
Actuator material	PPS, cover in Stainless steel 1.4561 (316Ti) PA, socle in Stainless steel 1.4308 1.4308 Stainless steel (CF8) PPS/PPS, PPS/St. steel (DN65, 80, 100 in full stainless steel)															
Element (DN08-50)																
Classic (DN65-100)																
Robolux Manual																
Pilot air ports	G 1/8" or Push-In															
Media temperature	-5 to +143°C (SIP: up to +150°C, 60 min.) +5 to +130°C (SIP: up to +143 °C, 60 min.) ²⁾ -10 to +130°C (SIP: up to +140°C, 60 min.) +5 to +90°C (no steam)															
EPDM (AD)																
advanced PTFE/EPDM (EU) ¹⁾																
advanced PTFE laminated on EPDM (EK) ²⁾																
Ambient temperature	+5 to +60°C															
Control medium	Neutral gases, air															
Installation for self-draining	See configuration option on page 6															

¹⁾ Advanced PTFE/EPDM is recommended for sterilization cycle

²⁾ only Robolux

Technical data, *continued*



Pneumatic actuator

	Port connection DN		Orifice (diaphragm size) [mm]	Actuator size Ø [mm]	Permitted pilot pressure [bar]		Max. operating pressure for seal material [bar]	
	[mm]	[inch]			min.	max.	EPDM, FKM	PTFE/EPDM and advanced PTFE/EPDM
ELEMENT 	8	1/4"	8	50	5	10	10	10
	10	3/8"	8	50	5	10	10	10
	15	1/2"	15	70	5	10	10	10
	20	3/4"	20	70	5	10	10	10
	25	1"	25	70	5	10	6.5	6
				90	5.5	10	10	8
	40	1 1/2"	40	130	5	7	10	10
50	2"	50	130	5	7	8	7	
Classic 	65	2 1/2"	50 or 80	125	5.5	7	8	7
			225	5	6	10	10	
	80	3"	80	225	5	6	10	10
	100	4"	100	225	5	6	8	4

Pneumatic actuator

	Actuator size [mm]	Actuator version	Pilot pressure [bar]	Max. operating pressure for seal material [bar]	
				EPDM	advanced PTFE/EPDM
Robolux 	RV50	D11	6-10	7.5	7.5
		D55 (reduce spring force)	4-10	5	3.5
	RV70	D11	6-10	8	8
		D55 (reduce spring force)	4-10	5.5	6
	RV110	D11	6-7	7	7.5
		D55 (reduce spring force)	4-7	5	5

Manual actuator

	Port connection DN		Orifice (diaphragm size) [mm]	Max. operating pressure for seal material [bar]	
	[mm]	[inch]		EPDM, FKM	PTFE/EPDM and advanced PTFE/EPDM
	8	1/4"	8	10	10
	10	3/8"	8	10	10
	15	1/2"	15	10	10
	20	3/4"	20	10	10
	25	1"	25	10	10
	40	1 1/2"	40	10	10
	50	2"	50	7/10	7/10
	65	2 1/2"	50 or 80	5/7/10	5/7/10
	80	3"	80	5	5
	100	4"	100	5	5

Pressure values (bar)

Gauge pressures with respect to the prevailing atmospheric pressure.

Remark:

For low operating pressures we recommend reduced spring force versions to prolong the life of the diaphragm

Materials

ELEMENT actuator DN08- DN50

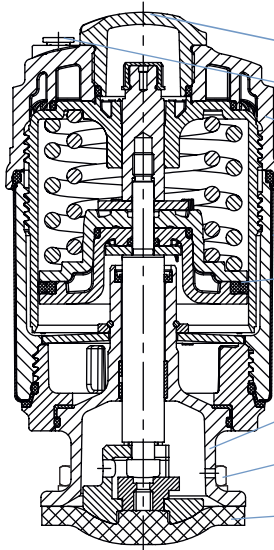

- Optical position indicator** Transparent cap polysulfone PSU
- Pilot air ports** Push-in connector PP (standard)
on request: Thread 1/8" stainless steel 1.4305
- Actuator cover** PPS
- Cover** Stainless steel 1.4561 (316Ti)
- Piston seal** FKM
- Socle** Stainless steel 1.4308
- Screws** Stainless steel
- Diaphragm** EPDM, PTFE/EPDM
(advanced PTFE/EPDM, FKM on request)

Classic actuator DN65- DN100

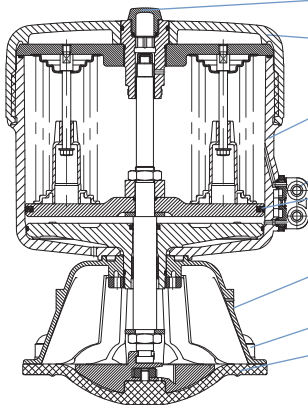

- Optical position indicator** Transparent cap polycarbonate PC
- Actuator** PA Polyamide
- Pilot air ports** Thread 1/8" stainless steel 1.4305
- Piston seal** NBR
- Socle** Stainless steel 1.4308
- Screws** Stainless steel
- Diaphragm** EPDM, PTFE/EPDM
(advanced PTFE/EPDM, FKM on request)

Robolux actuator

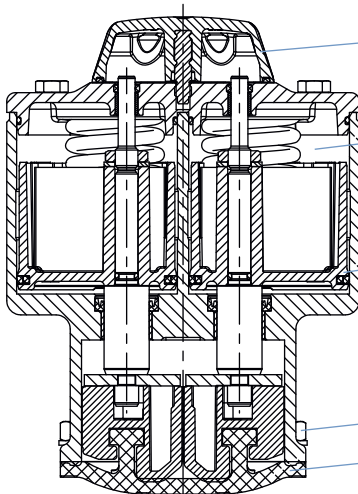

- Optical position indicator** Transparent cap Polyamide 12
- Actuator** Stainless steel 1.4308/PPS
- Piston seal** FKM
- Screws** Stainless steel
- Diaphragm** EPDM, advanced PTFE/EPDM

Materials, continued

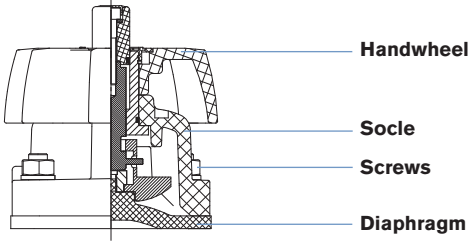
Manual actuator DN08 - DN100	
	
Handwheel	PPS or 316L stainless steel*
Socle	PPS or 316L stainless steel*
Screws	Stainless steel
Diaphragm	EPDM, PTFE/EPDM advanced PTFE/EPDM

* DN65 to DN100 only in stainless steel

Approvals/certifications

- Certification of Conformity for Raw Material EN-ISO 10204 3.1
- Attestation of compliance with the order EN-ISO 10204 2.1
- Test report EN-ISO 10204 2.2
- Certification of Conformity for Pickling and Electropolishing Processes
- Certification of Conformity for the Surface Quality DIN4762-DIN4768-ISO/4287/1
- Certification for the fulfillment of FDA CFR No. 21.177.1550 for PTFE/EPDM and advanced PTFE/EPDM and 21.177.2600 for EPDM
- USP CLASS VI certification for EPDM and PTFE diaphragm
- Test Certification and Conformity Certification for the Final Assembly of Diaphragm Valves
- ISO 9001 Certification

Note: Retrospective manufacturing certification for process diaphragm valves can not be made, therefore please notify when ordering.

Example of available diaphragm materials

Developed to handle the unique challenges of hygienic and sterile applications, Bürkert offers diaphragms with precise material formula and physical tolerances. Bürkert diaphragms are available in a wide range of materials which have been proven in food & beverage, biotechnology, pharmaceutical and cosmetic industry applications. Diaphragms are tested during development and production to ensure reliability in critical processing environments.

	<ul style="list-style-type: none"> ▪ EPDM ▪ PTFE/EPDM ▪ advanced PTFE/EPDM ▪ FKM
---	--

Valve features, specification key 1

Example

2034	B	04	05	E	R	VI	EU	25	0403
------	---	----	----	---	---	----	----	----	------

Specification key

(Please make a choice)

2034									
------	--	--	--	--	--	--	--	--	--

PRODUCTION OF BODY	
B	Bloc material

AMOUNT OF VALVE SEATS	
01	Seat
02	Seats
:	Seats
05	Seats
06	Seats

NUMBER OF PORTS	
01	Connection
02	Connections
:	Connections
07	Connections
08	Connections

ACTUATOR VERSION	
E	ELEMENT actuator
K	CLASSIC actuator
R	Robolux actuator
X	Robolux & CLASSIC
Y	Robolux & ELEMENT
Z	ELEMENT & CLASSIC

OPERATION	
M	Manual
P	Pneumatic
R	Pneumatic with control
X	Manual & Pneumatic

BODY MATERIAL	
VH	1.4435/AISI 316L
VI	1.4435 acc. to BN2/ASME BPE

SEAL MATERIAL	
AB	EPDM
EU	Advanced PTFE
FF	FKM
AD	EPDM for high temperature
EK	Advanced PTFE laminated on EPDM (only Robolux)

MAIN ORIFICE [mm]	
8	
15	
20	
25	
40	
50	
65	
80	
100	

CONFIGURATION

0201	see next page for further info go to page
0202	
0203	
0227	
0233	
0234	
0236	
GMP3	
GMP4	
GMP5	
GMP6	
SAP1	
SAP2	
SAP3	
SAP4	
SAP7	
SAP8	
0235	
0325	
0301	
0303	
0319	
0413	
0403	
0416	
0417	
0501	
0602	
CSBS	

Configurations

0201	0202	0203
0227	0233	0234
0235	0236	

Configurations, *continued*

GMP3	GMP4	GMP5
GMP6		
SAP1	SAP2	SAP3

Configurations, *continued*

SAP4	SAP7	SAP8
0301	0303	0319
0325		

DTS 1000213540 EN Version: D Status: RL (released | freigegeben | validé) printed: 22.09.2017

Configurations, *continued*

0403	0413	0416

0417

0501

0602

Valve features, specification key 2

Example

2034	25	A	25	A	25	A	20	A	-	-	-	-
SODF	SODF	SODF	SA93	SODF	-	-	-	-	NK52 + NO23			

Specification key

(Please make a choice)



VALVE/SEAT n°1		Actuator version	
Orifice DN [mm]			
08		Pneumatic	
15	A	normally closed by spring action	
20	B	normally open by spring action	
25	I	double acting	
40		Manual	
50	D050	Handwheel PPS / bonnet PPS	
80	D052	Handwheel stainless steel / bonnet stainless steel (only DN65-DN100)	
100	D058	Handwheel PPS / bonnet stainless steel with hole for bolts	

VALVE/SEAT n°2, 3.... x		Actuator version	
Orifice DN [mm]			
08		Pneumatic	
15	A	normally closed by spring action	
20	B	normally open by spring action	
25	I	double acting	
40		Manual	
50	D050	Handwheel PPS / bonnet PPS	
80	D052	Handwheel stainless steel / bonnet stainless steel (only DN65-DN100)	
100	D058	Handwheel PPS / bonnet stainless steel with hole for bolts	

VARIABLE CODES	
Surface finish, external	
NO22	glass bead blasted Ra=3.2 µm
NO34	Mechanical polished Ra=1.2 µm
NO15	Electro polished Ra=0.8 µm
Surface finish, internal	
NO23	Mechanical polished Ra=0.6µm
NO16	Electro polished Ra=0.6µm
NO14	Mechanical polished Ra=0.5µm
NO17	Elektropoliert Ra=0.4µm
Certificat	
NK52	3.1 Certificate integrated

Port connection Valve/Seat S1

Port connection Valve/Seat S2, S3... Sx

DN [mm]	Port connection weld end							
	EN ISO 1127/ ISO 4200 DIN 11866 S. B	SMS 3008	DIN 11850 S. 0	DIN 11850 S. 1	DIN 11850 S. 2 DIN 11866 S. A	DIN 11850 S. 3	BS4825	ASME BPE DIN 11866 S. C
4			SC40 - 6.0x1.0					
6	SA78 - 10.2x1.6		SC41 - 8.0x1.0					SA89 - 3.17x0.56
8	SA40 - 13.5x1.6		SC42 - 10.0x1.0				SODB - 6.35x1.2	SA90 - 6.35x0.89
10	SA41 - 17.2x1.6			SF40 - 12.0x1.0	SD40 - 13.0x1.5	SE40 - 14.0x2.0	SODC - 9.53x1.2	SA91 - 9.53x0.89
15	SA42 - 21.3x1.6	SA58 - 12.0x1.0	SC43 - 18.0x1.5	SF41 - 18.0x1.0	SD42 - 19.0x1.5	SE42 - 20.0x2.0	SODD - 12.7x1.2	SA92 - 12.7x1.65
20	SA43 - 26.9x1.6	SA59 - 18.0x1.0	SC44 - 22.0x1.5	SF42 - 22.0x1.0	SD43 - 23.0x1.5	SE43 - 24.0x2.0	SODE - 19.05x1.2	SA93 - 19.05x1.65
25	SA44 - 33.7x2.0	SA60 - 25.0x1.2	SC45 - 28.0x1.5	SF43 - 28.0x1.0	SD44 - 29.0x1.5	SE44 - 30.0x2.0		SODF - 25.4x1.65
32	SA45 - 42.4x2.0	SA61 - 33.7x1.2	SC46 - 34.0x1.5	SF44 - 34.0x1.0	SD45 - 35.0x1.5	SE45 - 36.0x2.0		
40	SA46 - 48.3x2.0	SA62 - 38.0x1.2	SC47 - 40.0x1.5	SF45 - 40.0x1.0	SD46 - 41.0x1.5	SE46 - 42.0x2.0		SODH - 38.1x1.65
50	SA47 - 60.3x2.0	SA63 - 51.0x1.2	SC48 - 52.0x1.5	SF46 - 52.0x1.0	SD47 - 53.0x1.5	SE47 - 54.0x2.0		SODI - 50.8x1.65
65	SA48 - 76.1x2.0	SA64 - 63.5x1.6			SD48 - 70.0x2.0			SODJ - 63.5x1.65
80	SA49 - 88.9x2.3	SA65 - 76.1x1.6			SD49 - 85.0x2.0			SODK - 76.2x1.65
100	SA39 - 114.3x2.3	SA66 - 101.6x2.0			SD50 - 104.0x2.0			SODL - 101.6x2.11

DN [mm]	Port connection Clamp				
	Clamp 34,0 like DIN 32676 S. B (ISO-tube (ISO4200))	DIN 32676 S. A (DIN-tube (DIN11850))	DIN 32676 S. B (ISO-tube (ISO4200))	ASME BPE	BS 4825 (Clamp BS 4825-3, tube BS 4825-1)
8	TC51 - 13.5x1.6 Ci: 34.0	TD40 - 10.0x1.0 Ci: 25.0	TC40 - 13.5x1.6 Ci: 25.0	TG50 - 6.35x0.89 Ci: 25.0	
10	TC41 - 17.2x1.6 Ci: 34.0	TD41 - 13.0x1.5 Ci: 34.0	TC53 - 17.2x1.6 Ci: 25.0	TG01 - 9.53x0.89 Ci: 25.0	
15	TC42 - 21.3x1.6 Ci: 34.0	TD42 - 19.0x1.5 Ci: 34.0	TC52 - 21.3x1.6 Ci: 50.5	TG02 - 12.7x1.65 Ci: 25.0	TH42 - 12.7x1.2 Ci: 25.0
20		TD43 - 23.0x1.5 Ci: 34.0	TC43 - 26.9x1.6 Ci: 50.5	TG03 - 19.05x1.65 Ci: 25.0	TH43 - 19.05x1.2 Ci: 25.0
25		TD44 - 29.0x1.5 Ci: 50.5	TC44 - 33.7x2.0 Ci: 50.5	TG04 - 25.4x1.65 Ci: 50.5	
32					
40		TD46 - 41.0x1.5 Ci: 50.5	TC46 - 48.3x2.0 Ci: 64.0	TG05 - 38.1x1.65 Ci: 50.5	
50		TD47 - 53.0x1.5 Ci: 64.0	TC47 - 60.3x2.0 Ci: 77.5	TG06 - 50.8x1.65 Ci: 64.0	
65			TC48 - 76.1x2.0 Ci: 91.0	TG07 - 63.5x1.65 Ci: 77.5	
80			TC49 - 88.9x2.3 Ci: 106.0	TG08 - 76.2x1.65 Ci: 91.0	
100			TC50 - 114.3x2.3 Ci: 130.0	TG09 - 101.6x2.11 Ci: 119.0	

Note
You can fill out the fields directly in the PDF file before printing out the form.

Standard configuration – request for quotation

▶ Please fill out and send to your nearest Bürkert facility* with your inquiry or order

Company	Contact person
Customer no.	Department
Address	Tel./Fax
Postcode/town	E-Mail

= mandatory fields to fill out Quantity Required delivery date

Operating data

<input type="checkbox"/> Process medium	<input type="text"/>		
<input type="checkbox"/> Type of media	<input type="checkbox"/> Liquid	<input type="checkbox"/> Steam	<input type="checkbox"/> Gas
	Nominal	Unit	
<input type="checkbox"/> Flow rate (Q, QN, W) ¹⁾	<input type="text"/>	<input type="text"/>	
<input type="checkbox"/> Temperature at valve inlet	<input type="text"/>	<input type="text"/>	
<input type="checkbox"/> Absolute pressure at valve inlet	<input type="text"/>	<input type="text"/>	
<input type="checkbox"/> Absolute pressure at valve outlet	<input type="text"/>	<input type="text"/>	
Steam pressure Pv	<input type="text"/>	<input type="text"/>	

¹⁾ standard unit:
Liquid Q = m³/h;
Steam W = kg/h;
Gas Qn = nm³/h

Valve features

Specification key 1 2034









(automatically transferred from p 5)

Specification key 2 2034

(automatically transferred from p. 10)

Accessories

Click on the orange box „More info.“ below... you will come to our website for the resp. product where you can download the datasheet.

Pilot valve	Stroke limitation	Position feedback/Control head
<input type="checkbox"/> Type 6012 	<input type="checkbox"/> Min./max. stroke limitation, with visual position indicator <input type="checkbox"/> Max. stroke limitation, without visual position indicator 	<input type="checkbox"/> Type 8690  <input type="checkbox"/> Type 8691  <input type="checkbox"/> Type 8695  <input type="checkbox"/> Type 8697  <input type="checkbox"/> Type 8685  <input type="checkbox"/> Type 8686 
Please specify item no. (if known): <input type="text"/>	Please specify item no. (if known): <input type="text"/>	Please specify item no. (if known): <input type="text"/>
for actuator (A1, A2,...) <input type="checkbox"/> <input type="text"/>	for actuator (A1, A2,...) <input type="checkbox"/> <input type="text"/>	for actuator (A1, A2,...) <input type="checkbox"/> <input type="text"/>

Certifications

- Attestation of compliance with the order EN-ISO 10204 2.1
- Certification of Conformity for Pickling and Electropolishing Processes
- Test report EN-ISO 10204 2.2
- FDA and USP compliance
- Certification of Conformity for Raw Material EN-ISO 10204 3.1
- Certification of Conformity for the Surface Quality DIN4762-DIN4768-ISO/4287/1

Customized configuration – request for quotation

▶ Please fill out and send to your nearest Bürkert facility* with your inquiry or order

Company	Contact person
Customer no.	Department
Address	Tel./Fax
Postcode/town	E-Mail



Bloc solution

Sales data

Project name: _____

Quantities: _____ single enquiry
 enquiry for series

Flow schematic

Warning: connection and valve description should be in accordance with the table that filled below!

Please sketch the schematic

Legende

Diaphragm valve - one seat
 Area with **minimum** volume
 Drain direction
 Flow direction
 Connection C1, C2, ... - System / Bloc
 A1, A2, ... actuator (Bloc valves)
 Optional indication of inlet and outlet
 (horizontal or vertical available)

C1 ... Cn
 A1 ... An
 (V / H)

Technical data -Fluidic

Medium nature	_____	Medium pressure	_____
Medium temperature	_____	Medium viscosity	_____
Kv value or flow rate	_____	<input checked="" type="checkbox"/> Bürkert standard in blue	
Material for the bloc	<input checked="" type="checkbox"/> 1.4535 / 316L	<input type="checkbox"/> 1.4435 acc.to BN2 / ASME BPE	Specific material: _____
Surface finish (internal)	<input type="checkbox"/> 0.8 <input checked="" type="checkbox"/> 0.6 <input type="checkbox"/> 0.4 <input type="checkbox"/> 0.25		Specific surface finish (Ra in µm): _____
	<input type="checkbox"/> Electropolish		_____
Surface finish (external)	<input checked="" type="checkbox"/> 1.6		Specific surface finish (Ra in µm): _____
Diaphragm material	<input checked="" type="checkbox"/> EPDM <input type="checkbox"/> PTFE <input type="checkbox"/> FKM <input type="checkbox"/> Silicone (only Robolux)		_____

Connection definition

Nominal size C-Nr.	DN	Weld end			Clamp			Divers
		DIN 11850 S2 DIN 11866 SA	ISO 4200 EN ISO 1127 DIN 11866 SB	ASME BPE DIN 11866 SC	DIN 32676 S.A	DIN 32676 S.B	ASME BPE	
C1	_____	<input type="checkbox"/>	<input type="checkbox"/>	<input type="checkbox"/>	<input type="checkbox"/>	<input type="checkbox"/>	<input type="checkbox"/>	_____
C2	_____	<input type="checkbox"/>	<input type="checkbox"/>	<input type="checkbox"/>	<input type="checkbox"/>	<input type="checkbox"/>	<input type="checkbox"/>	_____
C3	_____	<input type="checkbox"/>	<input type="checkbox"/>	<input type="checkbox"/>	<input type="checkbox"/>	<input type="checkbox"/>	<input type="checkbox"/>	_____
C4	_____	<input type="checkbox"/>	<input type="checkbox"/>	<input type="checkbox"/>	<input type="checkbox"/>	<input type="checkbox"/>	<input type="checkbox"/>	_____
C5	_____	<input type="checkbox"/>	<input type="checkbox"/>	<input type="checkbox"/>	<input type="checkbox"/>	<input type="checkbox"/>	<input type="checkbox"/>	_____
C6	_____	<input type="checkbox"/>	<input type="checkbox"/>	<input type="checkbox"/>	<input type="checkbox"/>	<input type="checkbox"/>	<input type="checkbox"/>	_____
C7	_____	<input type="checkbox"/>	<input type="checkbox"/>	<input type="checkbox"/>	<input type="checkbox"/>	<input type="checkbox"/>	<input type="checkbox"/>	_____
C8	_____	<input type="checkbox"/>	<input type="checkbox"/>	<input type="checkbox"/>	<input type="checkbox"/>	<input type="checkbox"/>	<input type="checkbox"/>	_____

Actuator and actuation see specification on next page.

Customized configuration – request for quotation, *continued*

Automation system (product overview)

ELEMENT actuator system

compact stainless steel design
 designed for modular actuation
 fresh air system

ELEMENT control head Type 8691

integrated pilot valve
 position teach in
 large LED indication
 ASI and device net communication possible

ELEMENT control head Type 8695 for actuator 50mm

integrated pilot valve
 position teach in
 Large LED indication
 ASI and device net communication possible

ELEMENT feedback head Type 8690 / 8697

mechanical electrical feedback
 inductive feedback
 Eexi version

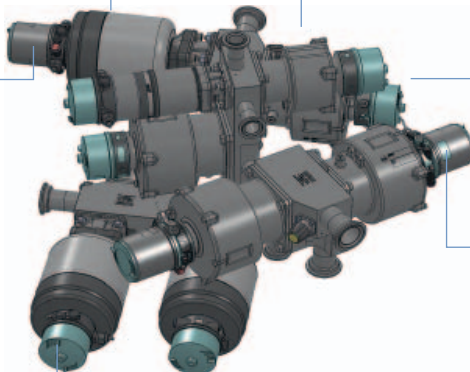

Robolux actuator system

double actuator with 2 valve function
 optimum designed for modular actuator concept
 high life time with double piston actuator

Robolux double feedback head Type 8685

contactless position detection
 LED indicator
 ASI communication
 Namur / Ex (without LED)

Robolux double control head Type 8686

2 pilot valve for multi port valve
 contactless position detection
 LED indicator
 ASI communication
 Namur / Ex (without LED)

Description fluidic system Type 2034
Detail information on www.burkert.com

Technical data - Actuation

Pilot pressure _____ Bürkert standard in blue

Ambient temperature _____

Cycle per year _____

Implementation (clean room, outside...) _____

Hazardous location (EX / ATEX / NAMUR) _____

Actuator material St. steel/Plastic Plastic

Power supply 8 V Namur 24 V/DC 230 V/50-60 Hz

IP protection IP65 IP67

Automation ASI DeviceNet

Remarks:

Other actuator material _____

Other protection / application conditions _____

Other power supply _____

Other automation (PLC / Fieldbus) _____

Definition actuation, feedback, pilote valves control head

Nominal size A-Nr.	DN	Actuator		Control feedback		Control head + Pilot valve	Control function	
		Pneumatic	Manual	Position ON	Position OFF		normally closed	normally open
A1	_____	<input type="checkbox"/>	<input type="checkbox"/>	<input type="checkbox"/>	<input type="checkbox"/>	<input type="checkbox"/>	<input type="checkbox"/>	<input type="checkbox"/>
A2	_____	<input type="checkbox"/>	<input type="checkbox"/>	<input type="checkbox"/>	<input type="checkbox"/>	<input type="checkbox"/>	<input type="checkbox"/>	<input type="checkbox"/>
A3	_____	<input type="checkbox"/>	<input type="checkbox"/>	<input type="checkbox"/>	<input type="checkbox"/>	<input type="checkbox"/>	<input type="checkbox"/>	<input type="checkbox"/>
A4	_____	<input type="checkbox"/>	<input type="checkbox"/>	<input type="checkbox"/>	<input type="checkbox"/>	<input type="checkbox"/>	<input type="checkbox"/>	<input type="checkbox"/>
A5	_____	<input type="checkbox"/>	<input type="checkbox"/>	<input type="checkbox"/>	<input type="checkbox"/>	<input type="checkbox"/>	<input type="checkbox"/>	<input type="checkbox"/>
A6	_____	<input type="checkbox"/>	<input type="checkbox"/>	<input type="checkbox"/>	<input type="checkbox"/>	<input type="checkbox"/>	<input type="checkbox"/>	<input type="checkbox"/>
A7	_____	<input type="checkbox"/>	<input type="checkbox"/>	<input type="checkbox"/>	<input type="checkbox"/>	<input type="checkbox"/>	<input type="checkbox"/>	<input type="checkbox"/>
A8	_____	<input type="checkbox"/>	<input type="checkbox"/>	<input type="checkbox"/>	<input type="checkbox"/>	<input type="checkbox"/>	<input type="checkbox"/>	<input type="checkbox"/>

Fluidic specification, connections, norms see previous page.

In case of special application conditions,
 please consult for advice.

Subject to alteration.
 © Christian Bürkert GmbH & Co. KG

1401/2_EU-en_00895250

DTS 1000213540 EN Version: D Status: RL (released | freigegeben | valide) printed: 22.09.2017