

INSTALLATION AND MAINTENANCE INSTRUCTIONS
CODE•MASTER 2™ AND CODE•MASTER 2™ FLOOD LUMINAIRE

Read carefully before attempting to install fixture.

Class I, Div. 1 and 2,
Groups C, D
Class II, Div. 1
Groups E, F, G
Class II, Div. 2
Groups F, G
Class III

UL 1598A, 844
Suitable for Use in Wet Locations

U.S. Pat. 3,170,750
Pat Can 1968

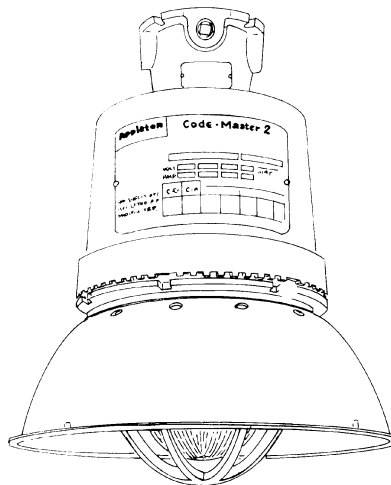

Code•Master 2™ and Code•Master 2™ Flood Factory Sealed Fixtures: Explosion-Proof, Dust-Ignition-Proof; 50W-400W

High Pressure Sodium: High Power Factor (Min.P.F. 90%), Metal Halide and Mercury Vapor: Constant Wattage (Min P.F. 90%), Pulse Start Metal Halide: Super CWA (Min. P.F. 90%).

Applications

- Ideal for use in chemical and petrochemical plants such as manufacturers of plastics, paints and thinners in refineries, and in other process areas where ignitable vapors, dust, moisture and corrosive elements may be present.
- Suitable for use in wet locations.

Features

- Fixtures operate safely in high ambient temperatures. For example, in Class I areas the 150W HPS fixture operates at a maximum temperature of 120°C in a 65°C ambient (100°C temperature in a 40°C ambient). See page 4 for specific ratings.
- Arrangement of heat-producing components results in more efficient heat dissipation for cooler fixture operations.

- Patented “wireless” design. Threading of fixture unit onto mounting hood makes electrical connection. Only wiring required is attaching two wires to connection block in mounting hood.
- Connection block is easily wired: (a) loosen two screws. (b) make wire connections (c) re-position connection block.
- Safe, easy servicing without disconnecting any wiring. “Wireless” fixture unit easily threads off mounting hood for convenient servicing or for immediate replacement with a “stand-by” unit.
- Acme double lead threads speed installation and fixture removal from mounting hood—only half as many turns are required as for single lead threads.

DIMENSIONS: Classified Area Suitability of Code•Master 2™ Series HID Fixtures (Suitability includes use of reflector.)

PENDANT

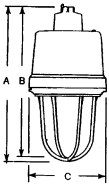

CEILING

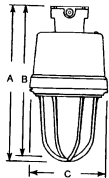

BRACKET

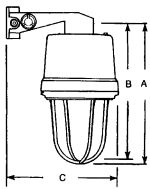

25° STANCHION

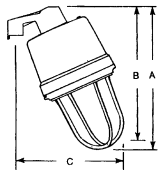

Lamp Type	Lamps Watts	Supply Wire °C	Ambient Temp °C	Class I, Div. 1 & 2 With Globe or with Globe & Reflector UL/NEC Temp. Ident. No.			† Class II, Div. 1 & 2 With Globe or with Globe & Reflector UL/NEC Temp. Ident. No.	
				Nameplate Marking		Groups	Nameplate Marking	Groups
Code•Master 2	Code•Master Flood	Code•Master 2	Code•Master Flood	Code•Master 2	Code•Master Flood			
High Pressure Sodium	50	60	40	T5	T5	C,D	T4	E,F,G
	50	75	55	T4A	—	C,D	—	—
	50	85	65	T4A	—	C,D	—	—
	70	60	40	T5	T5	C,D	T4	E,F,G
	70	75	55	T4A	—	C,D	—	—
	70	85	65	T4A	—	C,D	—	—
	100	60	40	T5	T5	C,D	T4	E,F,G
	100	75	55	T4A	—	C,D	—	—
	100	85	65	T4A	—	C,D	—	—
Metal Halide	150	60	40	T5	T5	C,D	T3A	E,F
	150	75	55	T4A	—	C,D	—	—
	150	85	65	T4A	—	C,D	—	—
	250	75	40	T3C	T4	C,D	—	—
	250	85	55	T3C	—	C,D	—	—
	400	85	40	T3C	T3A	C,D	—	—
	175	75	40	T4	T3B	C,D	T3C	E,F,G
	250	75	40	T4	T3B	C,D	T3A	E,F
	400	75	40	T3C	T3	C,D	—	—
Mercury Vapor	100	75	40	T3C	T3A	C,D	T3B	E,F,G
	175	75	40	T3C	T3A	C,D	T3A	E,F
	250	75	40	T3C	T3A	C,D	T3	E,F
Pulse Start Metal Halide	400	85	40	T3A	T2D	C,D	—	—
	175	75	40	T4	T3B	C,D	T3C	E,F,G
	250	75	40	T4	T3B	C,D	T3A	E,F
	320	75	40	T3C	T3	C,D	—	—
	350	75	40	T3C	T3	C,D	—	—
400	75	40	T3C	T3	C,D	—	—	

NOTE: The maximum operating temperature of the fixture must not exceed the ignition temperature of the gas, vapor or dust to be encountered per NEC 500-2(c). For ignition temperatures, see Cat. Sec. F1.

Applies to Code•Master 2 Only.

“T” Numbers Represent the Maximum Surface Temperature for Class I, Div. 1 Locations and Maximum Surface Temperature Under Dust Blanket for Class II, Div. 1 Locations.

“T” Number	T1	350	325	T2	T2A	T2B	T2C	T2D	T3	T3A	T3B	T3C	T4	T4A	T5	T6
Temp. Range (°C)	351-450	326-350	301-325	281-300	261-280	231-260	216-230	201-215	181-200	166-180	161-165	136-160	121-135	101-120	86-100	85

Type Reflector	A	B	C
Standard Dome	11.2	5.9	18.7
Deep Dome	10.56	7.0	17.5

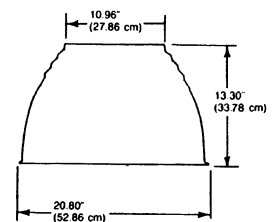
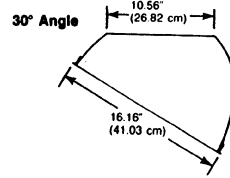
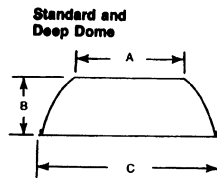

	Pendant			Ceiling			Bracket			25° Stanchion		
	A	B	C	A	B	C	A	B	C	A	B	C
Dimensions In inches												
50-250W*	21.5	20.5	12.0	21.61	20.61	12.0	21.86	20.86	17.5	19.5	18.7	16.0
250-400W	24.5	23.5	12.0	24.36	23.36	12.0	24.61	23.61	17.5	22.2	21.2	17.5

*50, 70, 100 and 150W HPS; 175 and 250W MH; and 100, 175 and 250W MV; 250 and 400W HPS and 400W MH and MV and 175, 250, 320, 350, 400W PSMH.

INSTALLATION AND MAINTENANCE INSTRUCTIONS CODE-MASTER 2™ LUMINAIRE

Read carefully before attempting to install fixture

VERIFY that the supply line voltage and fixture nameplate voltage are compatible. (If more than one ballast voltage is listed on nameplate, fixture contains a multi-tap ballast requiring one internal connection. (See below.)

VERIFY that the fixture operating temperature marked on nameplate complies with temperature restrictions of hazardous area.

USE supply wire rated for ambient temperature to be encountered. See nameplate.

INSTALLATION OF MOUNTING ACCESSORIES:

PENDANT HOOD

Remove connection block from hood by loosening two mounting screws. Thread hood onto conduit and tighten locking set screw. Connect the ground wire to the green screw provided in hood. Connect supply wires to connection block. Replace connection block into mounting hood and tighten securely.

STANCHION ARM

Remove connection block. Thread stanchion onto conduit and tighten locking set screw. Connect electrically as described under pendant hood.

WALL BRACKET AND CEILING BOX

Install wall bracket or ceiling box on support surface with four bolts through four external mounting holes. Remove connection block and connect electrically as described under pendant hood.

INSTALLATION OF FIXTURE

Single voltage fixtures are completely wired, needing no additional field wiring. Fixtures with multi-tap ballasts (more than one ballast voltage listed on nameplate) need to have one ballast primary lead connected to fixture lead.

REMOVING GLOBE-RING ASSEMBLY

Loosen round head locking screw in globe ring until screw clears pry bars in ballast housing. Unthread globe-ring assembly (Do not hold glass globe to unthread globe-ring assembly as this might loosen globe locking ring. Should the globe locking ring be accidentally loosened it must be retightened. Loosen set screw in globe locking ring and tighten the locking ring, then retighten the set screw.) A screwdriver inserted through slot in ring and operated against pry bars in housing will assist in removing globe-ring assembly.

WIRING MULTI-TAP BALLAST

Loosen the three screws securing the socket support plate, remove plate and set aside (enough slack in the wires is provided). Locate fixture lead marked "Line" and connect to ballast voltage lead corresponding to supply voltage. All other ballast voltage leads must remain capped. Replace socket support plate and tighten the three screws.

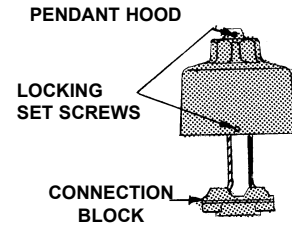
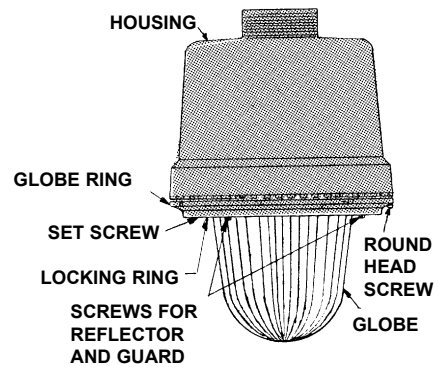

CEILING BOX

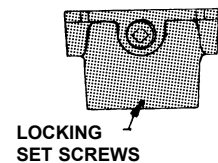

STANCHION ARM

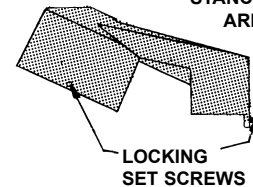

WALL BRACKET

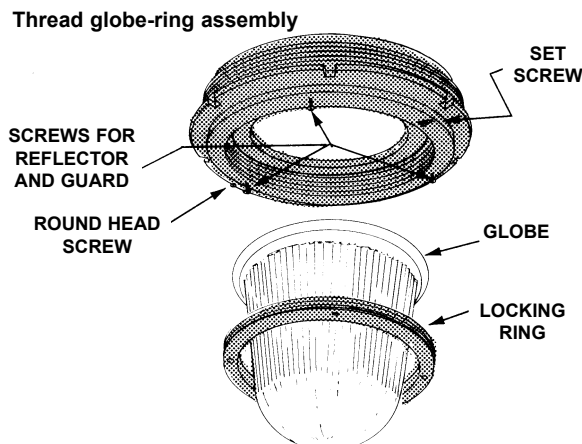
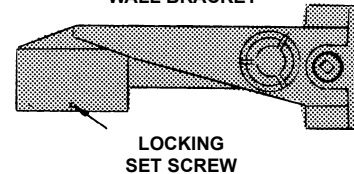

INSTALLING LAMP AND CLOSING FIXTURE

Check lamp type and wattage against fixture nameplate, then install lamp and tighten to achieve sufficient torque to fully depress socket center contact. Rethread globe-ring assembly into housing until hand tight and lock in place by driving locking screw to engage pry bar.

GLOBE-RING ASSEMBLY TIGHTENING INSTRUCTIONS

The globe-ring assembly must be tightened to compress gasket to insure watertightness. Thread globe-ring assembly by hand until gasket makes contact with housing, then rotate additionally past three notches or for 2 inches of travel. To assist in rotating globe-ring assembly, use two screwdrivers inserted through slots on opposite sides of ring and operated against pry bars in housing.

INSTALLING FIXTURE ON MOUNTING ACCESSORY

Install assembled fixture by threading into mounting accessory, the electrical contacts will automatically engage. Insure that fixture is tightly threaded, then tighten locking set screw in bottom of mounting accessory.

INSTALLATION OF REFLECTOR AND GUARD

Reflectors and guards are provided with keyhole slots. To install, loosen three screws in the globe ring and assemble reflectors or guards. Tighten the three screws. When an angle reflector is used, orient reflector to direct the main light beam near desired direction. Fine tune by rotating globe ring assembly after loosening round head locking screw. Retighten locking screw.

RELAMPING

CAUTION: DISCONNECT THE FIXTURE FROM SUPPLY CIRCUIT BEFORE OPENING TO SERVICE. KEEP TIGHTLY CLOSED WHEN IN OPERATION.

To relamp, after disconnecting power, open fixture as described under "Removing globe-ring assembly." Remove old lamp and install new as described under "Installing lamp and Closing Fixture."

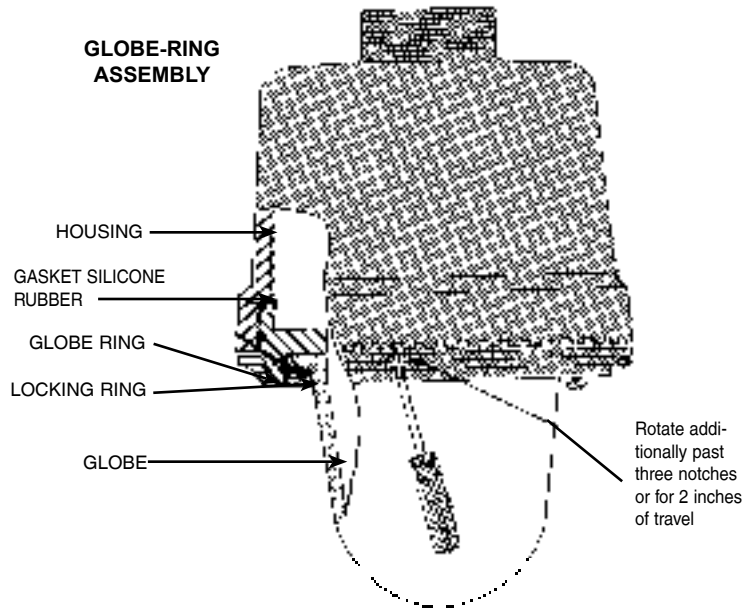

WIRING DIAGRAMS

